

DEPARTMENT OF
PRIMARY INDUSTRIES



Drought Feeding and Management of Beef Cattle

A guide for farmers and land managers

Published by the Victorian Government
Department of Primary Industries, March 2007

© The State of Victoria, Department of Primary
Industries, 2007.

This publication is copyright. No part may be
reproduced by any process except in accordance with
the provisions of the Copyright Act 1968.

Authorised by the Victorian Government
1 Spring Street, Melbourne
Victoria 3000 Australia

First edition 2002
Revised and reprinted March 2007

Contact details:
Department of Primary Industries
Phone: 136 186
www.dpi.vic.gov.au

ISBN 978-1-74199-055-3 (print)
ISBN 978-1-74199-035-5 (online)

Disclaimer

The advice provided in this publication is intended as a
source of information only. Always read the label before
using any of the products mentioned.

This publication may be of assistance to you but the
State of Victoria and its employees do
not guarantee that the publication is without flaw of any
kind or is wholly appropriate for
your particular purposes and therefore disclaims all
liability for any error, loss or other
consequence which may arise from you relying on any
information in this publication.

***For more information about DPI visit the website
at www.dpi.vic.gov.au or call the DPI Customer
Service Centre on 136 186***

Contents

Introduction	3
Acknowledgments	4
Glossary	4
Chapter 1 Preparing for drought	5
Developing an action plan	5
Courses of action	5
Chapter 2 Pasture management and utilisation in drought	9
Maximising winter production	9
Nitrogen fertiliser	9
Pasture as a component of drought rations	9
Chapter 3 Monitoring stock condition	13
Feeding cattle for controlled weight loss	15
Chapter 4 Choosing a feed	16
A balanced ration and the nutritional value of different feeds	16
Energy	16
Protein	16
Fibre	17
Dry matter	17
Costing fodders on energy value	19
How to calculate the cost of feed on an energy basis	19
Other factors to consider when buying fodder	21
Drought feeding of stock – the risk of chemical residues	22
Chapter 5 Feeding cattle	23
Nutritional requirements of beef cattle	23
Energy and protein requirements of various classes of cattle	24
Minerals	28
Vitamins	28
Feeding straw and urea	28
Molasses	29
Chapter 6 Water during a drought	30
Will I have enough water?	30
Animal requirements	30
How to calculate how much water you have	30
Water quality	31
What options are available to reduce water requirements?	31
Actions to address a water shortage	32

Chapter 7 Feeding grain to cattle	33
Chapter 8 Animal health and welfare	36
Health and welfare problems in beef herds in a drought	36
Class of livestock affected	36
The effect of disease on drought-affected cattle	37
Chapter 9 Feeding in stock containment areas	39
When to utilise a stock containment area	39
Animal health	41
Chapter 10 Early weaning of beef calves	43
Chapter 11 Creep feeding of beef calves	46
Chapter 12 Opportunity lotfeeding of beef cattle	48
Chapter 13 Stock and pasture management at the end of a drought	51
Feeding stock at the end of a drought	51
Pasture recovery after a drought	52
Chapter 14 The feed value of unusual feedstuffs	55
High moisture content feeds	55
Blending and levels of feeding	55
Types of feeds	56
By-product energy concentrates	56
By-product protein concentrates	58
By-product roughage	58
Chapter 15 FEEDTEST® – feed quality assessment for beef cattle	62
Appendix 1	64
List of Tables	65
Index	66

Introduction

Droughts are very much a part of farming in Australia. They occur at irregular intervals and their impacts on farming enterprises, rural communities and the environment are considerable. They result in increased costs, decreased production and income and increased mental and physical strain to those affected.

Periods of drought require landholders to make important decisions that will have short and long-term impacts on a farming enterprise. This booklet is a practical guide that will assist you to manage the planning, feeding and recovery periods of a drought. It contains a range of technical information adaptable to individual conditions and situations, and tools to reduce the costs and impacts incurred.

Droughts can be very difficult, but planning and management based on sound information will help you through the experience. The Victorian beef industry has resilient beef producers and communities who have combated such adversity before and will continue to do so in the future.

If you require more information please contact the Department of Primary Industries on 136 186.

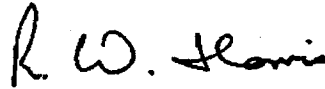

Ron Harris
Executive Director
Catchment Agriculture Services
Department of Primary Industries

Acknowledgments

The Department of Primary Industries thanks the following people and organisations for their contribution to this publication:

Phil Franklin, Meat and Wool Sub Project Manager, DPI Ballarat
Kate Sargeant, Beef Industry Development Officer, DPI Seymour
Dougal Purcell, Beef Industry Development Officer, DPI Rutherglen
Cheryl Graham, Special Projects Officer, DPI Wangaratta
Ross Batten, Meat Industry Development Officer, DPI Seymour
Tim Hollier, Meat and Wool Project Manager, DPI Rutherglen
Dr Karin Morgan, District Veterinary Officer, DPI Seymour
Dr David Champness, District Veterinary Officer, DPI Hamilton
Sam Ellis, Sheep Industry Development Officer, DPI Kerang
Emma Weatherly, Beef Industry Development Officer, DPI Hamilton
Fiona Baker, Beef Industry Development Officer, DPI Ellinbank
Meat & Livestock Australia

Glossary

kg	kilograms	MJ	megajoules
g	grams	T	tonnes
mm	millimetres	ME	metabolisable energy
cm	centimetres	ppm	parts per million
l	litres	DM	dry matter
m ²	square metres	CP	crude protein
		EC	electrical conductivity

Chapter 1

Preparing for drought

Developing an action plan

Droughts are changing situations that require continual reassessment of feed and financial resources and the ability to take relief measures quickly at minimum cost. For these reasons there is no standard recipe on how to best manage beef cattle in a drought. No two periods of feed shortage are the same and a manager's choice of the least-cost course of action will depend on such factors as:

- current saleyard prices for stock
- amount of fodder on hand
- funds available for purchase of fodder
- availability and reliability of stock water

Courses of action

The *Prevention of Cruelty to Animals Act* (1986) and the relevant Codes of Accepted Farming Practice for the Welfare of Livestock removes the option of 'doing nothing'. Cattle must not be left to starve to death or die of thirst.

The following courses of action are open to producers:

- agist stock
- sell stock
- feed stock.

Agistment

Sending cattle away on agistment can be a cheap solution to the feeding problem. Your agisted animals may even fatten on good quality agistment and any cattle left at home will have less competition for feed.

Before agisting cattle there are certain points that you should consider. This is best done by inspecting the agistment area to check for the following:

- secure fencing and cattle handling facilities
- good quantity of quality feed
- good water supply
- stock must be supervised to minimise theft or deaths
- stock need to be identified in some permanent way, for example, National Livestock Identification System (NLIS) electronic identification.

Only cattle strong enough to travel should be agisted. It is an advantage to have the agistment area close to markets so that agisted cattle do not have to be brought home again.

Most agistment will be snapped up early during dry times – particularly if the drought is widespread – so this decision must be made swiftly.

One form of agistment is to send cattle to a commercial feedlot, particularly if finishing cattle for a market.

Sell stock

Selling cattle provides ready cash as well as extra paddock feed for stock on hand.

If you choose this course of action, the crucial management decisions will be the timing of the sale and the type and number of cattle to be sold.

Any drought is inevitably triggers a period of intense selling with large saleyard yarding and resultant depressed prices. As much as possible, plan selling to avoid such buyers' markets.

When selling cattle the best policy is to sell the less productive animals, so that at the end of the drought a core of high-producing animals will remain. The decision to sell should be made quickly, before the condition of the stock deteriorates and market prices become depressed.

The best cattle to retain through a drought are young breeders of good quality because these will be difficult and expensive to replace at the end of a prolonged drought. An effective breeding program will result in the young breeders having the best genetics in the herd. They will provide the basis for bringing a beef herd back into production.

The following example sets out the steps of a selling policy to retain a breeding herd:

- pregnancy test and sell all empty, late-calving and low-producing cows; sell inferior bulls
- sell non-breeding cattle: weaners, yearling steers and bullocks. Growing stock can be expensive to feed because of their high protein demands

- sell aged cows, aged bulls and lightweight heifers
- wean calves over three months of age and sell or feed separately
- progressively reduce the breeding cow herd. Reassess the cow herd and sell the poorest performing cows and heifers. Young breeders (2-5 years) are the most important to retain.

Feed costs, saleyard prices and expected stock water supplies are key factors that need to be assessed each time the number of stock to sell is considered.

Herd rebuilding can be a slow process – long-term as well as short-term implications of any selling policy need to be considered.

Feed Stock

Inevitably, a decision will be made to feed at least some stock. Drought feeding of cattle is most efficient if the stock are segregated into various classes so that they can be fed according to their nutritional requirements.

Suggested classes could be:

- early weaned calves (less than six months)
- weaners (6-13 months)
- yearlings (12-18 months)
- cows with calves at foot
- dry cows
- bulls
- steers and bullocks (over 18 months).

Each class of stock varies in its susceptibility to drought. Table 1 provides maintenance feeding requirements for full hand-feeding of some common classes of stock. Stock requirements are fully discussed in later chapters.

It is important to obtain and provide vendor declarations on all cattle sold or purchased, to meet industry requirements. Vendor

declarations are available from Meat and Livestock Australia and can be ordered online at www.mla.com.au.

Stock feeds vary in their feed value. Moisture content, protein and energy level together determine the relative value of one feed against another. This is discussed in later chapters.

Generally, grain is often more readily available and better value for money during times of drought, compared to hay which tends to become scarce and overpriced quite early.

Your own attitude to risk and the accuracy of your feed budgeting will determine when you buy in additional feed.

How much to feed?

Developing feed budgets before and during a drought is key to minimising the financial impact on your enterprise. Accurate feed budgeting will minimise costs and increase animal production in the short and longer term.

Table 1 gives an indication of the amount of hay, grain or silage an animal will require for maintenance per day when relying totally on supplementary feed. This will help you to calculate how much fodder you may require over a given period of time. An example of how to do this is provided in Example 1.

You should always complete your own individual feed budgets that take into consideration the feed available, cost, what feeds you are able to handle on your farm and the current and desired fat score of your animals.

Table 2 provides the assumptions for the figures in Tables 1, 3 and 4.

Table 1. Quantities for full hand feeding (kg/hd/day) of common classes of stock

	Hay	Grain:Hay 50:50		Grain:Hay 70:30		Hay:Grain 70:30		Silage	Weight gain
	Kg hay	Kg grain	Kg hay	Kg grain	Kg hay	Kg hay	Kg grain	Kg silage	Kg/day
Adult dry stock (450kg)	8	3	3	4	2	5	2	14	Nil
Pregnant cow last 3 mths (450kg)	9.5	4	4	5	2	6	2.5	17	Nil
Lactating cow (450kg) plus calf (0-3 mths)	12*	4.5	4.5	6	3	7	3	21	Nil
Weaner steer/ heifer (250kg)	7*	3	3	3.5	1.5	4	2	12.5*	0.5
Yearling steer/ heifer (350kg)	9*	4	4	5	2	5.5	2	16*	0.5

- The figures in this table are 'as fed' rather than on a dry matter basis.
- Figures have been rounded to the nearest 0.5kg.
- Further detail, including quantities to feed different classes of stock for weight gain, can be found in Table 13 on page 26.
- * These rations will not meet the protein requirements to achieve the stated level of performance.

Table 2. Assumptions used in Tables 1, 3 and 4

Animals	Energy requirement (MJ ME/hd/ day)	Crude protein	Maximum dry matter intake (kg/hd/day)
Adult dry stock (450kg)	57	6	6
Pregnant cow last 3 mths (450kg)	69	6	10
Lactating cow (450kg) plus calf (0-3 mths)	85	8.5	10
Weaner steer/heifer (250kg) 0.5kg/day gain	50	10.5	6.5
Yearling steer/heifer (350kg) 0.5kg/day gain	64	9.5	8.5
Fodder	Energy value (MJ/kg DM)	Crude protein (%)	Dry matter (%)
Hay (medium-quality pasture or cereal hay)	8.5	8.5	85
Grain (rolled barley or pellets)	12	11	90
Silage (medium-quality pasture or cereal silage)	9	8.5	45

Working out how much to feed for a drought period – full hand feeding

Example 1: Ned has cut his herd down to 50 of his best young breeders between 3 and 5 years of age. He has a large amount of medium-quality hay stored in his shed and so he plans to feed with this until the cows calve in March. He then plans to switch to a 70% pellet and 30% hay diet to meet the protein needs of the cows after calving. He will continue to feed this ration for the remainder of the feeding period. He has no pasture available.

Date start feeding: 1st December

Anticipated end feeding: 1st May

Total days feeding: 180 days

Stock to be fed: 50 cows (450kg) calving in March

Ration required for the DRY, PREGNANT COWS for 120 days until calving (see Table 1):
 $9.5\text{kg hay/hd/day} \times 50\text{ hd} = 475\text{kg/day} = 1.4\text{ large round bales/day or } 21\text{ small squares/day}$

(See Appendix 1 for bale weight conversions).

Ration required for COWS AND CALVES for the last 60 days of the feeding period:
 $6\text{kg pellets/hd/day} \times 50\text{ hd} = 300\text{kg/day}$

$3\text{kg hay/hd/day} \times 50\text{ hd} = 150\text{kg hay/hd/day} = 0.4\text{ large round bales or } 6.5\text{ small square bales}$

Total hay required for the feeding period:

$1.4\text{ large round bales/day} \times 120\text{ days} + 0.4\text{ large rounds/day} \times 60\text{ days} = 192\text{ large round bales}$

or

$21\text{ small squares/day} \times 120\text{ days} + 6.5\text{ small squares/day} \times 60\text{ days} = 2910\text{ small square bales}$

Pellets required for feeding period:
 $300\text{kg/day} \times 60\text{ days} = 18\text{ tonnes pellets}$

Chapter 2

Pasture management and utilisation in drought

Maximising winter production

Pasture growth is the cheapest source of feed over winter. During a green drought however, where germination occurs but pasture growth is minimal due to a dry cold winter, other action will be required.

In green droughts use fodder supplements to maximise pasture growth over autumn/winter, lengthen the grazing rotation and build up a bank of pasture or 'feed wedge' ahead of the herd. As well as helping pasture growth, this will also give some height to pasture so that it can respond to nitrogen fertiliser.

Nitrogen fertiliser

Nitrogen fertiliser can be used to:

- promote extra spring growth, and enable a bank of feed for fodder conservation
- maximise autumn/winter growth at the end of a drought.

Although there are costs involved and adequate rainfall is still required, it may be an option for some beef producers.

The cost of extra pasture produced from nitrogen fertiliser can be around one third that of grain (and one quarter that of hay), assuming average responses from the fertiliser and good utilisation of the extra pasture grown. A typical response time is four to six weeks, so action needs to be taken early to use this option. Note also that stock cannot be grazed on treated pastures for 21 days after application because of the risk of nitrate poisoning.

Nitrogen needs to be used on responsive paddocks. They must have:

- a high level of nutrients
- adequate pasture height, 4cm or higher
- contain productive pasture species.

Nitrogen, therefore, should be used on your most productive paddocks to ensure maximum response from your money spent.

The response of pastures to nitrogen is also highly dependent on soil temperature. Higher responses will be seen in warmer soils. For this

reason, use nitrogen early in the season, just after the break. If in doubt, try a trial strip and see what happens.

Summary

For beef producers facing a feed shortage, a range of options are available. The earlier the decisions are made the better (and usually the cheaper the outcome). Each farm situation is different and needs to be considered on its own merits.

Pasture as a component of drought rations

The need for supplementary feeding and the quantity required will depend on the availability and quality of the pasture. The following section provides a simple guide to help you estimate pasture quantity and quality to determine the contribution of the pasture as part of a ration.

Pasture availability

The quantity of pasture in a paddock is called the pasture availability and is measured in kilograms of dry matter per hectare (kg DM/ha). Pasture availability, by definition, is the weight of pasture from a hectare if it was cut right to ground level and completely dried to remove all moisture.

Green pasture availability is determined by measuring the average height of the pasture in centimetres (using a stick or ruler) and calibrating the height to kg DM/ha using Figure 1. **When using this method, the first 0.5cm should be excluded from the measurement.** Non-digestible species such as onion weed should also be excluded from the measurements.

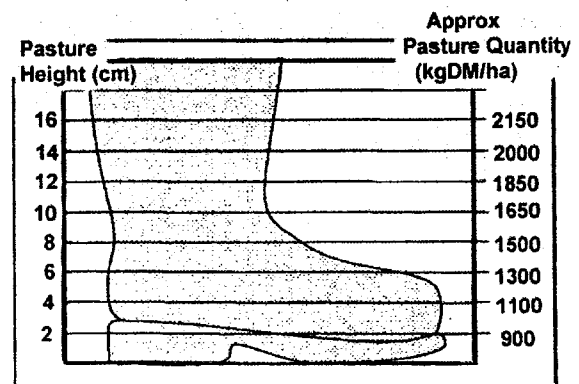

Figure 1. The relationship between green pasture height and pasture availability

Dry pasture, however, cannot be calibrated using Figure 1 because it has a lower moisture content to green pasture. For dry pasture use the following procedure (illustrated in Figures 2 and 3) to get an accurate estimate:

- make a wire square 33 x 33 cm
- take 15-20 33 x 33 cm pasture cuts (to the ground) from the paddock
- dry each sample in the microwave
- weigh the pasture in grams using kitchen scales
- multiply the average weight (g) of the samples by 100 to get the kg DM/ha



Figure 2. 1000kg dry matter, 50% digestibility

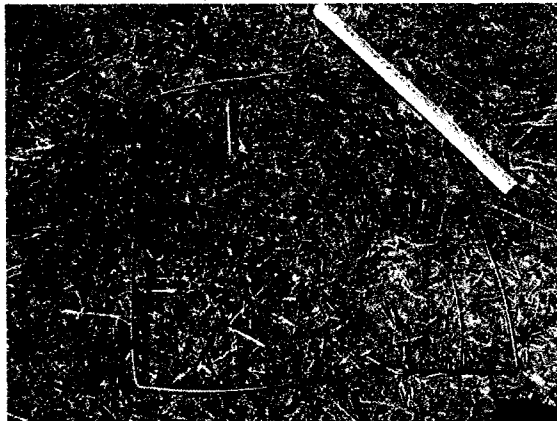

Figure 3. 500kg dry matter, 50% digestibility

Pasture quality

Pasture quality is determined by the digestibility of the green and dead herbage, clover content and the proportion of dead herbage present.

With dry herbage, protein content is also important, as it can limit the performance of some classes of stock. The protein level of dry pasture will range from 5-8% of dry matter. The protein level of green pasture ranges from 12-30% of dry matter (depending on the amount of clover present).

Digestibility is the proportion of the pasture eaten that is retained by the grazing animal. For example, if green pasture has a digestibility of 75%, it means that 75% of the pasture eaten will be used by the animal and 25% will pass out as faeces. A highly digestible feed will be digested quicker allowing for greater intake and hence greater animal production. Pastures with high digestibility will also be high in energy (Table 3). Other factors which influence quality of pasture include:

Green versus dead

The quality of green pastures is higher than dead herbage of the same species. Quality gradually declines as pasture ages from the vegetative to reproductive state.

Difference between pasture species

There is often little difference between annual and perennial grasses early in the growing season. Towards the end of the growing season, however, annuals such as silver grass and barley grass quickly decline in quality when they produce seed heads and die. Perennial grasses maintain higher quality longer and usually have some green material present.

Legumes are particularly high in protein and usually have roughly the same energy value as perennial grasses. Animals gain weight faster when grazing legume pastures compared to a grass pasture with the same pasture availability.

Table 3 illustrates the energy supplied by pastures of different quality and quantity. Use this table in conjunction with Tables 2 and 4 as a guide when developing rations for stock where some pasture is available. See Examples 2 and 3 to see how this can be done.

Table 3. Metabolisable energy (MJ/hd/day) supplied by pasture of different quality and availability

Pasture description	Dry, poor species	Dry, improved species	Going to seed	Green, grassy	Green, good clover	
						Digestibility %
Energy value	4 MJ/kg	6 MJ/kg	8 MJ/kg	11 MJ/kg	12 MJ/kg	
Livestock class	Pasture available					
Pregnant cow (450kg)	500kg/ha	5	14	24	40	61
	1000kg/ha	8	21	37	62	83
Lactating cow (450kg) and calf (0-3 mths)	500kg/ha	7	27	36	62	91
	1000kg/ha	12	33	56	93	120
Weaner steer (250kg)	500kg/ha	5	14	25	43	64
	1000kg/ha	8	22	38	59	84

Use Table 3 to determine the energy supplied by the pasture. Table 4 can then be used to determine the amount of feed required to make up the rest of the ration. See Examples 2 and 3 for further explanation of how these tables can be used together.

Table 4. Feed required to supply different levels of energy

Energy (MJ/day)	10	20	30	40	50	60	70	80	90	100	110	120	130
Kg hay/day	1.4	2.8	4.2	5.5	6.9	8.3	9.7	11.1	12.5	13.8	15.2	16.6	18
or													
Kg grain*	0.9	1.9	2.8	3.7	4.6	5.6	6.5	7.4	8.3	9.3	10.2	11.1	12
or													
Kg hay (50%)	0.6	1.1	1.7	2.2	2.7	3.3	3.9	4.4	5	5.5	6.1	6.6	7.2
Plus	Plus	Plus	Plus	Plus	Plus	Plus	Plus	Plus	Plus	Plus	Plus	Plus	Plus
Kg grain (50%)	0.6	1.1	1.7	2.2	2.7	3.3	3.9	4.4	5	5.5	6.1	6.6	7.2
or													
Kg hay (30%)	0.3	0.6	0.9	1.2	1.5	1.9	2.2	2.5	2.8	3.1	3.4	3.7	4.3
Plus	Plus	Plus	Plus	Plus	Plus	Plus	Plus	Plus	Plus	Plus	Plus	Plus	Plus
Kg grain (70%)	0.7	1.5	2.2	2.9	3.6	4.3	5	5.7	6.5	7.2	7.9	8.6	9.1

* If feeding grain only (no hay), pasture must be available to make up at least 30% of the ration.

Working out how much to feed for a drought period – taking into account paddock feed

Example 2: Joan has cows with two-month-old calves, grazing a short (500kg DM), green, grass-dominant pasture. How much would she need to feed them to make up the shortfall from the pasture?

Use of Tables 2-4 to develop a maintenance ration – green pasture

Step 1

Determine the class of livestock and look up their energy requirement in Table 2

Stock: Lactating 450kg cows with two-month-old calves at foot
Energy requirement (Table 2): 85 MJ//hd/day

Step 2

Determine the pasture availability and quality and then look up Table 3 to determine the energy the stock will obtain from pasture.

Pasture: 500kg/ha (1cm) of green, grassy pasture (70% digestible)
Energy from pasture (Table 3): 62 MJ/hd/day

Step 3

Determine the amount of extra energy required from supplement.

Energy required from supplement: 85 MJ/hd/day minus 62 MJ/hd/day = 23 MJ/hd/day

Step 4

Chose a supplement and look up Table 4 to find out how much you need to feed. In this example, the extra energy required is 23 MJ/hd/day. The 20 MJ/hd/day column in Table 4 is the closest to 23 MJ/hd/day. Look up this column to determine the supplement required.

Chosen supplement: Hay (50%) and processed grain (50%)
Hay and grain required (Table 4): 1.1kg hay/hd/day and 1.1kg grain/hd/day

Example 3: Julie has just weaned her calves. They weigh around 250kg and are grazing a perennial pasture in early summer with around 1000kg DM. How much would she need to feed them to make up the shortfall from the pasture?

Use of Tables 2-4 to develop a maintenance ration – dry pasture

Stock: 250kg weaners gaining 0.5kg/hd/day
Energy requirement (Table 2): 50 MJ/hd/day

Pasture: 1000kg/ha dry, improved species (50% digestible)
Energy from pasture (Table 3): 22 MJ/hd/day

Energy required from supplement: 50 MJ/hd/day minus 22 MJ/hd/day = 28 MJ/hd/day

Chosen Supplement: Hay (30%) and pellets (70%)
Hay and pellets required (Table 4): 0.9kg hay/hd/day and 2.2kg pellets/hd/day

Chapter 3

Monitoring stock condition

The body fat reserves of beef cattle are important at critical stages of the production cycle (growth, reproduction and lactation) and will need to be taken into consideration when developing drought-feeding rations. By assessing the stock and the amount of available pasture, the rate of supplementary feeding can be calculated to enable animals to reach desired production targets.

There are two ways to assess the condition of cattle – by weight and by fat score. The weight of cattle varies with the breed, sex, age and pregnancy status, so when feeding for survival during a drought, fat score is used as the standard. Fat scoring can be assessed manually and visually. Both techniques are described here. When weighing cattle, scales should be used rather than an estimate.

The aim of fat scoring is to obtain a simple and reliable estimate of the body fat reserves of live cattle. The fat score provides an estimate of fat reserves that is independent of the size of the animal. It is a more reliable description of condition than liveweight alone.

Hands-on technique

This technique is easily learnt and, although subjective, has been shown to give reliable results when related to subcutaneous fat cover.

Two areas of the animal's body are palpated to assess fat cover (see Figure 4). The two areas are:

- the short ribs
- around the tail head.

Fat is the only tissue layed down at these sites which makes them ideal for assessment. Other sites on the body are harder to assess because of the difficulty of determining the difference between fat and muscle.

The short ribs

The degree of fat deposition can be gauged by placing the fingers flat over the short ribs and pressing the thumb into the end of the short ribs (see Figure 5). A fat score is given according to the ease with which the individual short ribs can be felt with the thumb.

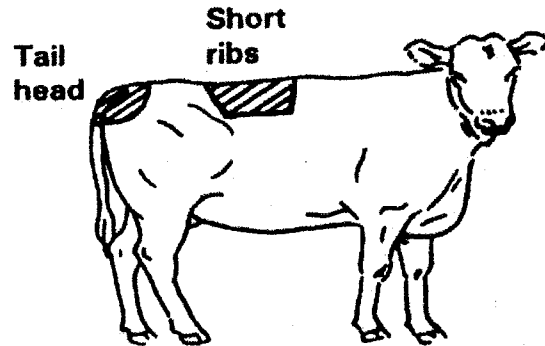

Figure 4. The two areas palpated to assess fat cover

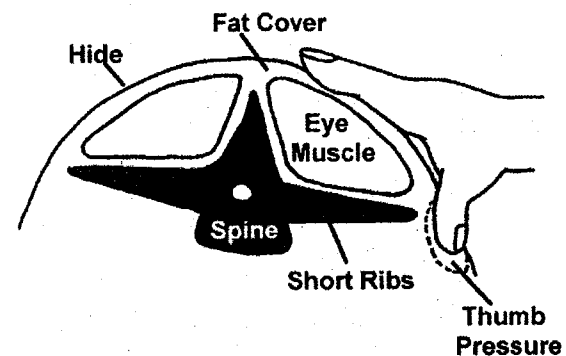

Figure 5. The degree of fat cover over the short ribs is assessed using the fingers and thumb

The tail head

The degree of fat cover around the tail head is assessed by using the fingers and thumb and should be done at the same time as assessing the short ribs. A score is given depending on the degree to which palpable fat can be felt.

Fat score descriptions

0. Emaciated

1. The individual short ribs are sharp to the touch; no tail head fat. The hip bones and ribs are prominent (0-2mm at p8 site).
2. The individual short ribs can easily be felt, but feel rounded, rather than sharp. There is some tissue cover around the tail head. Individual ribs are no longer visually obvious (3-6mm at p8 site).
3. The short ribs can only be felt with firm thumb pressure. Areas either side of tail head have fat cover which can be easily felt (7-12mm at p8 site).

4. The short ribs cannot be felt and fat cover around the tail head is easily seen as slight mounds, soft to touch. Folds of fat are beginning to develop over ribs and thighs (13-22mm at p8 site).
5. The bone structure of the animal is no longer noticeable and the tail head is almost completely buried in fatty tissue (23-32mm at p8 site).
6. Bone structure is hard to distinguish. Tail head buried in fat. All other sites show obvious soft fat deposits (33+mm at p8 site).

The score can be varied half a score depending upon the amount of tail head fat.

For example, if the short rib palpation (using the thumb) gives score 2H but the tail head is a typical 3, the score would then be 3L (H = high, L = low).

Visual assessment

Visual assessment is less accurate but will give a good idea with paddock inspections of cattle. The two main factors associated with cattle condition and finish are fat and muscle. These are assessed visually at three main sites – the rear, brisket and flank (Figure 6).

As cattle become fatter:

- the ribs become less visible
- the tail head softens with rounds of fat increasing behind the tail
- muscle seams on the hindquarters become less evident
- brisket, flank, cod and twist all fill out giving a squarer appearance.

There is no muscle in the tail head, flank, brisket and cod. If these areas are filled out, then they will be filled with fat which therefore makes them ideal sites to assess fat cover.

The same description of fat scores is used for manual and visual assessment. For more information on fat scoring animals contact your local Department of Primary Industries Beef Industry Development Officer.

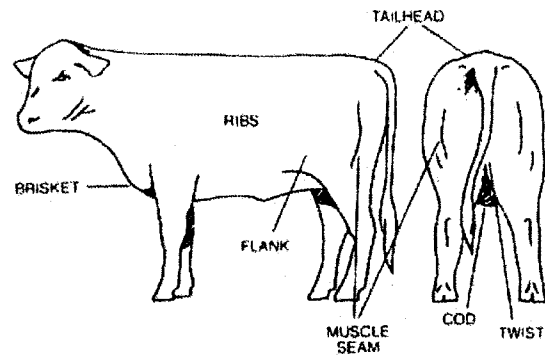

Figure 6. Reference points for visual assessment

Muscling

Indicators of muscling in order of importance are:

- thickness and roundness of the hindquarters
- width through the stifle (lower hindquarter)
- width across the back and the loin
- stance – how wide apart the animal stands, that is, the width between the hind legs and width between the forelegs.

Fat cattle look 'blocky' and square, well-muscled cattle look rounded. Observe cattle from behind to assess thickness through the lower hindquarters (stifle area). Heavily muscled stock are thickest here; they also stand with their legs further apart than lightly muscled stock.

Target fat scores

There will always be a range of fat scores within a mob of cattle. If the range is wide, splitting mobs according to fat score is common practice and a good idea. This will enable you to specifically match rations for each class of animal to achieve target fat scores.

Select a number of poorer animals in the mob to monitor regularly and then assess their progress towards the desired fat store every 2-3 weeks to gauge the direction of the mob. If the animals' progress is too quick or too slow, you can then adjust the ration to compensate.

Table 5. Minimum and desired fat scores for different classes of stock

	Minimum fat score	Fat score ideal for production
Dry cows	2	3
Cows – point of calving	3L (autumn)	3H (autumn)
	2H (spring)	3L (spring)
Cows – joining	2H	3-3H
Cows – mid lactation	2H	3
Weaners	2	2 – 3
Bulls at joining	3	3H

Feeding cattle for controlled weight loss

In the face of drought there are many important decisions to make. If you decide to retain and hand feed cattle then you will also need to decide which type and level of feed should be fed to which stock.

When serious drought conditions develop, a program of controlled weight loss for cattle may be necessary.

What is controlled weight loss?

Controlled weight loss is weight loss at a rate and to a point consistent with a good chance of survival under the expected feeding and environmental conditions.

The expected conditions will include adverse weather during and at the end of the drought, and management of associated health problems, including parasitism.

Cattle fed for survival require a greater degree of management skill, more frequent supervision and protection from the elements to ensure that their welfare is not compromised.

There is virtually no productive output at this level of feeding. Pregnant cows should be fed to allow them to calve without complications. Early weaning should be considered so that the cows can be treated as 'dry' adults that will have considerably lower nutritional requirements than lactating cows. The calves, however, will need high protein, good quality feed.

Breeding stock fed only for survival are not likely to be fertile so much lower conception rates should be expected. This is a sacrifice that has to be considered in the face of a serious drought. In some instances, it will be worthwhile feeding breeding stock to increase conception rates and minimise the long-term impact of the drought.

Survival requirements

The rate of weight loss should be controlled to ensure that cattle do not lose more than **0.5kg/day if between 6 and 12 months old**, and that they do not lose more than **1.0kg/day if older than 12 months**.

Cattle less than 6 months old should not be allowed to lose weight.

It is extremely important to monitor stock very closely during a period of weight loss.

To avoid greater rates of weight loss it may be necessary to begin supplementary feeding some time before paddock feed supplies are exhausted so that animals become familiar with the ration. A period of weight loss should not last longer than 6 months.

In an adult cow, one fat score is the equivalent of approximately 70kg. At a rate of 0.5kg weight loss per day, it would therefore take around 140 days for an animal to lose one fat score. Remember, cattle should not be allowed to fall below a fat score of 2.

Failure to control rates of weight loss will make cattle prone to starvation ketosis, with heavily pregnant, fat cattle being the most susceptible.

The consequences of feeding for survival

As already mentioned, the breeding pattern in a beef herd can be seriously disrupted if breeders are only fed survival diets. The following points should be considered before allowing stock to lose weight:

- heifers should be at least 300kg (British breeds) or 320kg (Euro breeds) to achieve cycling for joining. They should gain a further 100kg during pregnancy in order to calve without problems
- liveweight gain is almost impossible to achieve when maintenance requirements are high – such as when the animal is lactating. It is often cheaper to maintain cattle in good condition up to the point of calving
- cycling rate will be higher if the herd is on a rising plain of nutrition.

Chapter 4

Choosing a feed

A balanced ration and the nutritional value of different feeds

It is important to provide stock with a ration that will enable them to achieve a desired level of performance. Energy, protein and fibre are essential components of a balanced ration. Minerals and vitamins should also be taken into consideration.

The following section outlines the nutritional components of a range of foodstuffs fed to cattle.

The data presented should be considered as a guide only, hence it is advisable to have a sample analysed by FEEDTEST*. For further information on FEEDTEST*, see Chapter 15 on page 62.

Energy

The main requirement of stock is for energy (about 80% of the diet). Knowing the metabolisable energy (ME) values of different feeds is important for two main reasons:

- the ability of the animal to maintain their weight and production level (growth, reproduction and lactation) is highly dependent on meeting specific energy requirements. Farmers can only calculate the amount of feed required to meet production targets if they know the energy value of the various feeds that make up a ration
- deciding to buy feed should be based on the cost per unit of energy rather than the cost per tonne. See page 19 for further details on costing feeds on an energy basis.

One problem with feeding based on energy values is getting the stock to physically eat enough. Feeds high in fibre, such as mature pasture hay, cereal hay and straw, cannot be eaten in large quantities because they are digested slowly and stock physically can't fit enough in.

This shortfall in energy requirements results in the animal using body fat to meet its needs. To avoid this, do not use low energy feeds as a sole ration. Mix high-fibre feeds with higher

quality feeds, such as pasture, silage, good quality hay, grain or some other high energy-feed to meet overall requirements. The higher the energy requirement, the lower the amount of low-quality feed that can be used in the diet.

Protein

Protein is measured as percentage of crude protein. The protein requirements of cattle vary according to the weight and type of animal, as well as the level of production (growth, reproduction and lactation). Crude protein values give a good indication of whether or not a particular foodstuff will satisfy the protein needs of an animal.

Green pasture is high in protein (leafy pasture is 25-30% protein). Even short green pasture can go a long way to lifting the level of protein in the diet. When no green pasture is available, it is likely that protein intake may be below requirements. Failing to meet protein requirements will result in the energy in the diet not being completely used and may even result in stock using the breakdown of muscle to overcome the shortfall of protein.

Growing stock have high demands for protein. Steers and heifers weighing between 180kg and 400kg require 13% protein in their diet to grow 1kg/day. Early weaned calves have even higher requirements of 16% protein.

Some supplements, such as processed grain and pellets, are medium to high in protein and will be useful if they are cost effective and practical. Supplements that are likely to be low in protein include cereal hays, straws, low-quality pasture hays and some cereal grains. Lupins are very high in protein and are often added to a cereal grain to increase the protein level of the diet.

Forms of non-protein nitrogen such as urea and biuret are often used to increase the rate of digestion of high-fibre feeds such as hay and straw. In general terms, at least two-thirds of an animal's crude protein intake should be provided as true (natural) protein. That is, not more than one-third of the crude protein should be represented by non-protein nitrogen (NPN). These additives should not be included in levels above 2% of the diet.

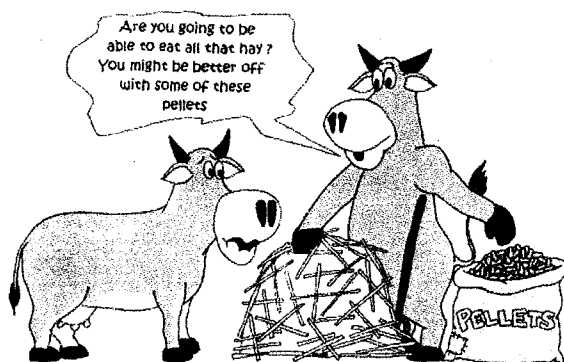

Fibre

Generally, cattle eating pasture will get enough fibre in their diet. Cattle need a certain amount of fibre in their diet to ensure that the rumen functions properly.

Too little fibre can result in acidosis, as the feed is digested too quickly and the rumen isn't able to function properly.

Too much fibre will restrict intake and animal performance because the feed is digested too slowly.

Neutral detergent fibre (NDF) is a measure of all the fibre (the digestible and indigestible parts) and indicates how bulky the feed is. A high NDF will mean lower intake. Conversely, lower NDF values lead to higher intakes. **The ideal level of fibre in the diet is 30% NDF for all classes of cattle.**

Low-fibre, high-starch diets (grains) cause the rumen to become acid. These feeds include cereal grains, some by-products and certain vegetables such as potatoes. These feeds need to be introduced into the diet slowly. See Chapter 7 for more detail on how to introduce cattle to grain.

If using low-fibre feeds, ensure there is adequate fibre in the diet. Hay, straw, silage and pasture all have a lot of fibre and can be used to keep fibre at the desired level. Oats are the safest and highest fibre grain with 29% NDF, compared with barley at 14% NDF and wheat at around 11% NDF.

Too much fibre, however, limits the amount an animal can eat and therefore their performance. For example, if cows with young calves are grazing poor pasture and fed a supplement of low-quality hay, their energy intake would be too low. This would result in cow weight loss and poor calf growth. In these instances, a low-fibre, high-energy supplement (such as grain or pellets) would need to be provided.

Dry matter

It is important to have some idea of the dry matter (DM) content of foodstuffs. All measurements of energy and protein are made on a Dry Matter basis so feeds of different moisture contents can be compared.

Silage has a high moisture content, around 45% dry matter. This means that 1 tonne of silage has only 450kg of dry matter and 550kg of water. Grain has a much lower moisture content, around 90% dry matter. This means that 1 tonne of grain has 900kg of dry matter and only 100kg of water.

Knowing the dry matter percentage enables you to work out exactly how much to feed to provide a certain amount of energy.

Example 4: If silage has an energy level of 11 MJ/Kg DM, how much silage do I need to feed 50MJ of energy?

Energy level: 11 MJ/kg DM

Energy level (as fed): $11 \text{ MJ/kg DM} \times 45\%$
= 5MJ/kg

Silage required: $50 \text{ MJ} \div 5 \text{ MJ/kg}$
= 10kg

Table 6. Energy and protein compositions of common livestock feeds (Pasture, hay, silage, straw)

Feed	Approx dry matter (DM) %	Metabolisable energy (ME) (MJ/Kg DM)		Crude protein % dry matter (ME/kg DM)	
		Average	Range	Average	Range
GRAZED PASTURES					
Grass-dominant pasture			3-14		1-37
Young, immature	23	11		25	
Mature	40	7		5	
Clover-dominant pasture			4-12		1-35
Immature	15	11		30	
Mature	30	4		7	
Lucerne			4-13		3-41
Young, immature	17	11		30	
Full bloom	24	8		15	
GRAZED CEREAL CROPS					
Barley/Oats			7-13		3-33
Early vegetative	19	9		20	
Post-bloom	21	10		8	
HAY					
Pasture hay, grass dominant			5-11		1-30
Flowering	80	10		9	
Two weeks after flowering	85	9		8	
Pasture hay, subclover dominant					
Flowering	80	9	7-11	13	8-26
Lucerne hay*			5-11		6-28
Pre-flowering	85	9	5-12	15	
Flowering	90	8		14	
Oaten/wheaten hay			5-11		1-16
Flowering	85	9		7	
Milk stage	87	8		5	
Ripe seed	90	8		3	
Canola hay	70	11	8-13	17	4-27
SILAGES					
Grass dominant	45	10	7-11	14	4-23
Legume dominant	44	10	8-12	15	8-28
Lucerne	51	10	7-11	19	11-27
Cereal	46	9	6-11	11	4-21
Canola	60	9	6-10	17	9-26
CEREAL STRAWS					
Barley, oaten, wheaten	90	5	4-7	2	1-4

Table 7. Energy and protein compositions of common grains (whole and processed)

IMPORTANT – Note the difference in energy levels for whole and processed grain	Approx dry matter (DM) %	Metabolisable energy (ME) (MJ/Kg DM)			Crude protein % dry matter (ME/kg DM)	
		When fed WHOLE to cattle	When fed rolled or coarsely milled to cattle		Average	Range
		OR when fed WHOLE to sheep				
		Average	Average	Range	Average	Range
Wheat	90	9	13	12-15	12	8-23
Barley	90	8.4	13	11-13	11	6-17
Triticale	90	10.4	13	12-15	12	9-15
Oats	90	10	11	9-13	9	6-12
Lupins	90	11	13	12-14	30	26-40
Peas	90	11	13	10-13	23	18-29
Maize	90	13	13.5	12-14	9	8-13
Safflower seeds	90		13	7-12	25	20-37
Rice (dehulled)	90		12	11-14	7	7-9
Rye	90		14		11	
Sorghum	90	10	13		11	
Pellets	90	N/A	12	10-14	12	11-16

WARNING: As seen from the very large ranges for each feed type, feeds vary considerably in their nutritional value depending on growing conditions, stage of harvesting and storage conditions. The only way to be sure of the nutritional value of a particular batch of feed is to have it tested for energy, protein and dry matter.

Costing fodders on energy value

Fodders such as grain and hay are always bought and sold on a price per tonne (or some other unit of weight or size) of feed. Feeds contain moisture, however, and therefore need to be converted to dry matter figures before they can be compared.

The most important basis for comparison of feedstuffs is their energy content. Tables 6, 7, 20 and 21 list the energy and protein values of a range of foodstuffs. It is important to realise that those values are all expressed on a dry matter (DM) basis.

The following section aims to help producers calculate which feed is the best value for money. To make comparisons you must first look at the energy and dry matter content of the feedstuff.

How to calculate the cost of feed on an energy basis

Example 5: Which feed is the best value on an energy basis?

	Cost/ tonne	Dry matter %	Energy MJ/Kg/ DM
FEED A	\$195	85%	10MJ
FEED B	\$230	90%	13MJ

FEED A: Calculate the cost/MJ of metabolisable energy

Step 1

Calculate the price of the feed on a dry matter basis @ 85% dry matter

In a tonne of this feed there is 850kg dry matter and the rest is water. To calculate the cost of a kilogram of dry matter, divide the cost/tonne of feed by the number of kilograms of dry matter.

$\$195/\text{tonne} \div 850\text{kg} = \$0.23/\text{kg dry matter}$
This is the same as **23 cents/kg dry matter**.

Step 2

Calculate the cost per MJ of Energy

In each kilogram of dry matter there are 10 MJ of energy.

$23\text{c}/\text{kg DM} \div 10\text{MJ}$
= 2.3c/MJ of metabolisable energy

Feed A costs 2.3c/MJ of energy

FEED B: Calculate the cost/MJ of metabolisable energy

Step 1

Calculate the price of the feed on a dry matter basis @ 90% dry matter

In a tonne of this feed there is 900kg dry matter and the rest is water. To calculate the cost of a kilogram of dry matter, divide the cost/tonne of feed by the number of kilograms of dry matter.

$\$230/\text{tonne} \div 900\text{kg} = \$0.26/\text{kg dry matter}$
This is the same as **26 cents/kg dry matter**.

Step 2

Calculate the cost per MJ of energy

In each kilogram of dry matter there are 10 MJ of energy.

$26\text{c}/\text{kg DM} \div 13\text{MJ}$
= 2.0c/MJ of metabolisable energy

Feed B costs 2c/MJ of energy

Therefore, Feed B is better value per unit of energy, costing 2c/MJ, compared to 2.3c/MJ for Feed A.

Table 8. Cents per megajoule of energy calculated from \$/tonne and MJ/kg DM

Fodder	MJ/ Kg DM	\$ / tonne															
		125	150	175	200	225	250	275	300	325	350	375	400	425	450	475	500
Grain / pellets	14.0	1.0	1.2	1.4	1.6	1.8	2.0	2.2	2.4	2.6	2.8	3.0	3.2	3.4	3.6	3.8	4.0
(Assuming 90% DM)	12.0	1.2	1.4	1.6	1.9	2.1	2.3	2.5	2.8	3.0	3.2	3.5	3.7	3.9	4.2	4.4	4.6
	10.0	1.4	1.7	1.9	2.2	2.5	2.8	3.1	3.3	3.6	3.9	4.2	4.4	4.7	5.0	5.3	5.6
	8.0	1.7	2.1	2.4	2.8	3.1	3.5	3.8	4.2	4.5	4.9	5.2	5.6	5.9	6.3	6.6	6.9
Hay	10.0	1.5	1.8	2.1	2.4	2.6	2.9	3.2	3.5	3.8	4.1	4.4	4.7	5.0	5.3	5.6	5.9
(Assuming 85% DM)	8.0	1.8	2.2	2.6	2.9	3.3	3.7	4.0	4.4	4.8	5.1	5.5	5.9	6.3	6.6	7.0	7.4
	6.0	2.5	2.9	3.4	3.9	4.4	4.9	5.4	5.9	6.4	6.9	7.4	7.8	8.3	8.8	9.3	9.8
Silage	14.0	2.2	2.7	3.1	3.6	4.0	4.5	4.9	5.4	5.8	6.3	6.7	7.1	7.6	8.0	8.5	8.9
(Assuming 40% DM)	12.0	2.6	3.1	3.7	4.2	4.7	5.2	5.7	6.3	6.8	7.3	7.8	8.3	8.9	9.4	9.9	10.4
	10.0	3.1	3.8	4.4	5.0	5.6	6.3	6.9	7.5	8.1	8.8	9.4	10.0	10.6	11.3	11.9	12.5
	8.0	3.9	4.7	5.5	6.3	7.0	7.8	8.6	9.4	10.2	10.9	11.7	12.5	13.3	14.1	14.8	15.6
Straw	6.0	2.3	2.8	3.2	3.7	4.2	4.6	5.1	5.6	6.0	6.5	6.9	7.4	7.9	8.3	8.8	9.3
(Assuming 90% DM)	4.0	3.5	4.2	4.9	5.6	6.3	6.9	7.6	8.3	9.0	9.7	10.4	11.1	11.8	12.5	13.2	13.9
	2.0	6.9	8.3	9.7	11.1	12.5	13.9	15.3	16.7	18.1	19.4	20.8	22.2	23.6	25.0	26.4	27.8

Example 6: Which is the best value for money – wheat or oats?

Wheat: \$300/t, 90% DM, 12 MJ/kg DM
Oats: \$275/t, 90% DM 10 MJ/kg DM

Cost per unit of energy (Table 8):
 Wheat = 2.8 c/MJ, Oats = 3.1 c/MJ

Therefore, wheat is the cheapest feed in this example.

Example 7: Which is the best value for money – silage or hay?

Silage: \$150/t, 40% DM, 12MJ/kg DM
Hay: \$250/t, 85% DM, 8MJ/kg DM

Cost per unit of energy (Table 8):
 Silage = 3.1c/MJ, Hay = 3.7c/MJ

Therefore, silage is the cheapest feed in this example.

Note: Hay and silage are often sold on a price per bale. See Appendix 1 for a guide to the common weight of small and large hay and silage bales.

Other factors to consider when buying fodder

The cost of feeding cattle is not just the cost to buy feed. Labour, freight, extra storage and handling costs, and the likely amount of wastage should also be taken into account.

Grain processing

Cattle only derive the full value from grains such as wheat, triticale and barley if the grain is rolled or coarsely milled (Table 7). Processing equipment can be expensive, but may be worth the investment if used on a large enough scale. When doing the sums, remember to include the time it will take to process the grain.

Storage, handling, feeding out

In general, grain is easier to store, handle and feed out than hay because it is not so bulky. Grain is usually a more saleable commodity than hay provided it is free of contaminants.

Availability

There is little use in starting cattle on a feed that is not readily available. Switching cattle too quickly from one feed to another carries with it a high risk of serious digestive upsets.

Cost of freight

The bulkiness and handling difficulties of some feedstuffs (for example, feeds high in moisture such as carrot pulp) mean higher freight costs compared to concentrated feeds such as grains.

On-farm storage

Not every property is suited to storing and feeding out grain and considerable expense may be needed before it becomes a practical alternative. Work out the difference in the cost of energy from hay versus grain for the estimated feeding period, and compare this to the price of a silo. You may like to factor in that the silo will still be there at the end of the drought and available for future use.

Noxious weeds

Take care to buy fodder that is free of noxious weeds. Weeds such as Paterson's curse, Bathurst burr, Variegated thistle, etc. can be a problem for years after a drought has ended if they are accidentally introduced onto a property. It is important to inspect all samples for weed seeds, however it is not always possible to detect a potential problem or even to refuse delivered feed on these grounds.

One way to minimise potential weed problems is to restrict feeding out suspect fodder to a limited number of paddocks. Stock must be boxed together in large mobs on stable soils. This can have the added advantage of preserving some vegetation on de-stocked areas of the farm, reducing the likelihood of severe erosion.

Tips for buying hay

Hay can be a good management option in some situations, but it can be expensive and often hard to find a quality supply.

An average dry cow requires 8.5kg DM/day to maintain herself (which is almost half a small bale). If high rates of grain are fed, 20-30% of the diet will need to be good-quality hay to maintain adequate fibre levels.

If you are buying hay from other districts then transport costs will be higher. Only buy high quality hay to avoid paying transport on low value feed. Buying locally if possible has the advantage of low transport costs and knowing the quality of the hay.

When buying, find out the feed value, how long it has been stored, the amount of legume or clover and whether there are any weeds present. Ask the vendor if any has been sold to your district so that you can inspect hay from the same batch before buying.

It is also a good idea to ask about the pasture species, the type of shed where the hay is stored and the stage of maturity that the hay was baled. If the vendor has good knowledge of their hay then they will be a genuine seller rather than a dealer in hay.

Be wary of any hay with Bathurst burr, Paterson's curse, heliotrope or barley grass. When feeding hay try to sacrifice a paddock so that any new weeds are kept in a confined area rather than spread over the whole farm. Watch this area the following year for any suspicious weeds and control them before they flower.

Any hay purchased from South Australia will need a Vendor Declaration to state that the hay was not grown within 100km of a known annual ryegrass toxicity site. The vendor must obtain the vendor declaration from the South Australian Department of Agriculture before offering the hay for sale.

If buying lucerne, be aware that first cut lucerne is of lower quality, will have a lower nutritive value and a greater number of annual weed seeds. If you do buy lucerne, make sure it has a fine stalk. It is also important to have a method of feeding that will avoid the loss of leaf. The best method is to feed lucerne in a feeder, or to mill the hay and feed in a feed trough. Dampening the lucerne hay the day before feeding will help to hold the leaf on the stem and reduce losses.

When buying hay try to purchase by weight and then calculate a price per tonne delivered to your property. The hay seller may have a FEEDTEST[®] analysis for the hay, which will give an accurate content of the metabolisable energy (ME) MJ/kg/DM, crude protein and fibre content. If these figures are available you can price your hay on a c/MJ ME basis and compare the various feeds on offer (see page 19). If you prefer, have your own feed sample analysed through the Department of Primary Industries FEEDTEST[®] service. See Chapter 14 for further details.

Drought feeding of stock – the risk of chemical residues

Many producers are tempted to try a variety of alternate feedstuffs. All information on the feed value of unusual feedstuffs is contained in Chapter 14. Alternative feedstuffs can range from waste plant products and vegetable matter from manufacturing processes, such as potatoes, citrus pulp, cabbage leaves and carrots, to manufacturing by-products such as cotton waste and sawdust.

Apart from their generally poor nutritional value, these 'unusual' feedstuffs could also be contaminated with high levels of chemical residue. Potentially all supplementary feeds may contain chemical contaminants, but 'unusual' feedstuffs, not normally used for feeding livestock, pose a much greater risk.

Agricultural chemicals used on fruit and vegetable crops are typically designed to be eliminated from the edible parts of the plant at harvesting. Some residues, however, may still be present in the waste plant material after processing and problems can occur when this is fed to stock.

Agricultural chemicals are not designed to be ingested and little is known about either their effect on livestock or the persistence of chemical residues in animal tissue.

There is a very real possibility that the meat from animals that are fed products containing chemical contaminants will themselves become contaminated with these chemicals. Producers should be aware of the Export Slaughter Interval (ESI) and the Withholding Period (WHP).

The ESI is the time that should elapse between administration of a agricultural or veterinary chemical to animals and their slaughter for export.

The WHP is the minimum period that must lapse between last administration or application of a agricultural or veterinary chemical, including treated feed and the slaughter of the animal for human consumption. WHPs are mandatory for domestic slaughter and on the label of every registered product.

Chemical-withholding periods must be observed for any chemical used in a crop. In some instances chemical use earlier on in the season may preclude the option of cutting for hay. It is essential that withholding periods be observed.

For this reason, the best policy is not to feed unusual feedstuffs to stock without first establishing that the material is suitable. Producers should ask the supplier of unusual feedstuffs to certify that the material they are supplying is suitable for the purpose for which it will be used.

Where possible, producers should obtain a commodities vendor declaration on any feedstuffs they buy.

Chapter 5

Feeding cattle

Nutritional requirements of beef cattle

Good feeding management is efficient feeding management. To achieve this, it is important to understand the nutritional requirements of particular classes of beef cattle.

You will need to know the approximate weight of each animal and the level of production (for example, growth rate or stage of reproduction) that is expected from it. For example, a 300kg steer to grow at 0.5kg per day; or a mature, dry cow which is seven months pregnant.

Once the nutritional requirements are known, it is important to try to provide that level of nutrition from the feed available on the farm – be it pasture alone, pasture plus supplements, or full feeding when there is no pasture remaining.

Although the production of beef cattle can be affected by a whole range of dietary mineral and vitamin deficiencies (or excesses), by far the most important nutritional limitations to production, are simply energy and/or protein.

This chapter tabulates the energy and protein requirements of various classes of cattle for a range of liveweights and growth rates.

Explanation of the terms used in the following tables

Liveweight, growth rate

To precisely plan feeding management, you need to have some idea of liveweights and growth rates of cattle. This can only be achieved by weighing cattle.

Maximum intake

Cattle have an upper limit to appetite. This can be defined either in terms of a percentage of their liveweight or as a weight of feed. One of the most common issues in a drought is that animals are physically not able to consume enough supplement to meet a required level of nutrition each day. See Tables 9-12 for maximum intake for different rations.

Metabolisable energy (ME) requirement

The ME value of a foodstuff is the amount of energy that a ruminant animal (sheep or cattle) is able to use, per kilogram that it consumes. The units of ME are megajoules (MJ) per kilogram of dry matter (DM) of the particular foodstuff.

The ME requirement of an animal can be accurately estimated, as long as its weight and level of production (for example growth rate or stage of reproduction) are specified.

Minimum ME concentration of diet

The minimum ME concentration of the diet is calculated from the relevant values for maximum daily dry matter intake and metabolisable energy requirement.

To achieve the stated level of production, it is necessary to ensure that the cattle have available a diet which has an energy level at least as high as the minimum value shown in the sixth column in Tables 9-12.

As an example of how these values could be used, a 300kg steer requires a diet with a minimum ME concentration of 10 to grow at 1kg per day. This is possible on young, growing green pasture (ME value of 11), but not on mature, dry pasture (ME value of 7). See Tables 6, 7 and 21 for the value of different feeds.

Crude protein percentage of dietary dry matter
Tables 9-12 show that the protein requirements of cattle vary according to the weight and type of animal, as well as the expected level of production.

Even when the ME concentration of the diet is adequate, if the protein percentage is inadequate, then the desired level of production will not be achieved.

If protein is the limiting nutrient in a diet, cattle may not be able to eat enough to satisfy their maintenance requirements. In some situations non-protein nitrogen (NPN) supplements such as urea can significantly stimulate appetite. See page 29 for further information on urea.

When pasture dries off, there can be plenty of dry-standing feed of low quality. Feeding animals NPN stimulates rumen microbes and increases feed intake, so that cattle consume more dry feed than they otherwise would. Animals can be fed a NPN source such as urea in the form of blocks, licks or urea fortified molasses. Adequate dry-standing feed must be available, however, or these supplements will simply be an extremely expensive source of energy.

Energy and protein requirements of various classes of cattle*Table 9. Steers and heifers (after weaning) (See Table 17, page 45 for early weaned, lighter calves)*

Liveweight (kg)	Growth rate (kg/ day)	Maximum daily dry matter(DM) intake		Metabolisable energy (ME) requirement (MJ/day)	Minimum ME concentration of diet (MJ/kg DM)	Crude protein percentage of dietary dry matter
		% of liveweight	(kg)			
150	0	2.9	4.3	22	5.2*	8
	0.5	2.9	4.3	37	8.7	12
	1.0	2.9	4.3	50	11.6	13
200	0	2.8	5.5	26	4.8*	8
	0.5	2.8	5.5	44	8.0	11
	1.0	2.8	5.5	59	10.7	13
300	0	2.5	7.6	35	4.6*	8
	0.5	2.5	7.6	57	7.5	10
	1.0	2.5	7.6	76	10.0	13
400	0	2.4	9.4	45	4.8*	8
	0.5	2.4	9.4	71	7.6	9
	1.0	2.4	9.4	93	9.9	13
500	0	2.1	10.7	55	5.1*	7
	0.5	2.1	10.7	82	7.7	10
	1.0	2.1	10.7	108	10.1	12

* Cattle on these diets may not eat to full appetite because of the very poor quality (low ME values) of these particular diets.

*Table 10. Cows dry, pregnant mature**

Liveweight (kg)	Growth rate (kg/ day)	Maximum daily dry matter (DM) intake		Metabolisable energy (ME) requirement (MJ/day)	Minimum ME concentration of diet (MJ/kg DM)	Crude protein percentage of dietary dry matter
		% of liveweight	(kg)			
350	0	2.4	8.5	48-60	5.6-7.1	6
400	0	2.3	9.4	52-65	5.5-6.9	6
450	0	2.2	10.1	57-69	5.6-6.8	6
500	0	2.1	10.7	61-74	5.7-6.9	6
550	0	2.0	11.2	66-78	5.9-7.0	6

* Range of values for cows which are 6-9 months pregnant

Table 11. Cows with suckling calves up to four months old

Liveweight (kg)	Growth rate (kg/day)	Maximum daily dry matter (DM) intake		Metabolisable energy (ME) requirement (MJ/day)	Minimum ME concentration of diet (MJ/kg DM)	Crude protein percentage of dietary dry matter
		% of liveweight	(kg)			
350*	0	2.4	8.5	74	8.7	10
	0.5	2.4	8.5	91	10.7	11
400*	0	2.3	9.4	80	8.5	10
	0.5	2.3	9.4	97	10.3	11
450	0	2.2	10.1	85	8.4	10
500	0	2.1	10.7	90	8.4	10
550	0	2.0	11.2	95	8.4	10

* Young cows at these weights probably need to put on some weight after calving (for example, 0.5kg/day) because they have not yet reached their adult weight and therefore need better feed than older cows.

Table 12. Bulls

Liveweight (kg)	Growth rate (kg/ day)	Maximum daily dry matter (DM) intake		Metabolisable energy (ME) requirement (MJ/day)	Minimum ME concentration of diet (MJ/kg DM)	Crude protein percentage of dietary dry matter
		% of liveweight	(kg)			
400	1.0	2.4	9.4	93	9.9	13
500	0.5	2.1	10.7	82	7.7	11
	1.0	2.1	10.7	108	10.1	12
600	0	2.0	11.7	63	5.4	10
	0.5	2.0	11.7	95	8.1	11
	1.0	2.0	11.7	122	10.4	12
800	0	1.8	14.4	81	5.6	10
	0.5	1.8	14.4	117	8.1	10

Table 13. Quantities for full hand feeding (kg/hd/day) for common classes of stock

	Energy Required MJ/day	Hay	Grain:Hay 50:50		Grain:Hay 70:30		Hay:Grain 70:30		Silage	Weight gain
		Kg hay	Kg grain	Kg hay	Kg grain	Kg hay	Kg grain	Kg silage	Kg/day	
Adult dry stock (450kg)	57	7.9	3.2	3.2	4	2	5	2	14.1	Nil
Pregnant cow last 3 mths (450kg)	69	9.6	3.8	3.8	5	2	6	2.4	17	Nil
Pregnant heifer last 3 mths (400kg)	82	11.3*	4.5	4.5	5.9	2.5	7	2.9	20.2	0.5
Lactating cow (450kg) plus calf (0-3 mths)	85	11.8**	4.7	4.7	6.1	2.7	7.2	3.1	21*	Nil
Lactating heifer (400kg) plus calf (0-3 mths)	97	13.4**	5.4	5.4	7	3	8	3.6	24**	0.5
Weaner steer/heifer (250kg)	30	4.2	1.7	1.7	2.2	0.9	2.5	1.1	7.4	0
	50	6.9*	2.8	2.8	4.2	1.8	3.6	1.5	12.3*	0.5
	68*	9.4**	3.8*	3.8*	5*	2*	5.6**	2.6**	16.8**	1
Yearling steer/heifer (350kg)	40	5.5	2.2	2.2	2.9	1.2	3.4	1.4	9.9	0
	64	8.9*	3.5	3.5	4.6	2	5.5	2.2	15.8*	0.5
	85	11.8**	4.7*	4.7*	6.1*	2.7*	7.2**	3.1**	21**	1

• The figures in this table are 'as fed' rather than on a dry matter basis.

• Assumptions for this table can be found in Table 2, page 7.

* These rations will not meet the protein requirements to achieve the stated level of performance.

* Stock may not be able to physically consume this much feed in a day.

How to do a feed budget

Example 5: The following example shows how a basic feed budget is worked out. The foodstuffs used have been chosen to give a rough indication of standard quality and quantity. It is important that you get your feed tested by FEEDTEST* to give an accurate indication of the feed quality, as this can have dramatic effects on the outcome of your feed budget. You should assign a percentage of the ration for each of the feeds used as this will help you determine the average of the energy and protein for the ration. See the example below.

1. Cattle

Type Mature cows with calves
Liveweight 450kg
Calves 3 months old
Growth Maintenance

2. Determine the energy and protein requirements of the cattle (Tables 9-12, pages 24-26)

Energy (Table 11, page 25) 85 MJ/hd/day
Protein (Table 11, page 25) 10%

3. Determine energy from pasture and therefore energy required from supplement (Table 3, page 11):

Quality:	Dry, poor species, 40% digestibility, 4 MJ/kg, 5% protein
Availability:	1000kg/ha
Energy from pasture:	8 MJ/hd/day
Energy required from supplement:	85 MJ/hd/day minus 8 MJ/hd/day = 77 MJ/hd/day

4. Determine energy, protein and dry matter values of available feeds, and the percentage of each to be included in the ration (this will depend on how much of each feed is available and which is the cheapest feed).

Pasture hay (Table 6, page 18)

Energy:	8.5 MJ/kg DM
Protein:	8.5% of DM
Dry matter:	85%
Energy (as fed):	85% x 8.5 MJ/kg DM = 7.2 MJ/kg as fed
% in ration:	30%

Pellets (Table 7, page 18)

Energy:	12 MJ/kg DM
Protein:	12% of DM
Dry matter:	90%
Energy (as fed):	90% x 12 MJ/kg DM = 10.8 MJ/kg as fed
% in ration:	70%

5. Determine the average energy value (as fed) of the ration and the total kg required

Average energy:	30% x 7.2 MJ/kg + 70% x 10.8 MJ/kg = 9.7 MJ/kg as fed	
Total kg required:	77 MJ/hd/day ÷ 9.7 MJ/kg = 7.9kg/hd/day as fed (see Table 11 on page 25 to see if this exceeds the amount the animals can physically eat in a day).	

Hay required: 0.3 x 7.9 = 2.4kg/hd/day

Pellets required: 0.7 x 7.9 = 5.5kg/hd/day

6. Is this meeting the protein requirements?

Because protein requirement is expressed as a percentage of dry matter eaten, first determine how much dry matter will be fed.

Dry matter of hay fed:	2.4 x 85%	= 2kg DM/hd/day
Dry matter of pellets fed:	5.5 x 90%	= 5kg DM/hd/day
Dry matter of pasture eaten:	8 MJ ÷ 4 MJ/kg DM	= 2kg DM/hd/day
Total dry matter fed:	2kg hay + 5kg pellets + 2kg pasture = 9kg DM/hd/day	

Protein percentage of ration:

Hay:	2kg DM ÷ 9kg DM x 8.5% protein	= 1.9%
Barley:	5kg DM ÷ 9kg DM x 12% protein	= 6.7%
Pasture:	2kg DM ÷ 9kg DM x 5% protein	= 1.1%
Total		= 9.7% protein

The protein in this ration is very close to meeting the 10% crude protein requirements for cows and calves. For young growing animals that have a higher protein requirement the protein content could be increased by using a higher protein pellet or by using a high protein grain such as lupins as part of the ration.

Minerals

When animals are removed from pasture and rely solely on a drought ration mineral supplementation may be required. Calcium (agricultural lime) and sodium (salt) are the most commonly required mineral supplements.

Calcium

Diets that have high grain percentages (greater than 50%) are generally calcium deficient. To prevent calcium deficiency, add ground agricultural limestone to cereal grain at a ratio of 1 part of limestone per 100 parts of grain (1%). If roughage represents 50% or more of the diet then calcium is not required.

Sodium

Diets that contain high grain percentages may require sodium (salt) to be added to the ration to prevent a sodium deficiency.

Add 0.5 parts of salt to 100 parts grain (0.5%). If stock water contains high levels of salt then additional supplementation may not be required.

Sodium bentonite

As a precaution against grain poisoning (acidosis), sodium bentonite can be mixed with the grain. It should be mixed at a ratio of 2 parts of sodium bentonite per 100 parts of grain (2%) for the first 30 days of grain feeding. See Chapter 7, Feeding Grain to Cattle.

Vitamins

Vitamins A and E are the most common vitamin deficiencies that develop when there is no green feed. A single intramuscular injection of A, D & E will protect against both deficiencies.

Vitamin A

Cattle that have not had access to green pasture, green coloured hay or yellow maize for an extended period (3 months) will be deficient in Vitamin A. Note that cattle will develop a Vitamin A deficiency in a shorter time off green feed than sheep. An injection of A, D & E will correct a deficiency for around 3 months.

Vitamin E

The amount of Vitamin A in grain, hay and straw can vary significantly. A deficiency may develop in some drought rations. An injection of A, D & E will correct any deficiency.

Feeding straw and urea

Straw is a generally cheap and available source of roughage (fibre) during a drought, however it is a poor quality feed for ruminants. Very high in fibre, low in energy and very low in protein, makes straw very slow to digest which means that the animal physically can't eat enough to satisfy even its maintenance requirement.

Treating straw with urea however, can lift the feed value of the straw and, when fed in conjunction with low quantities of grain, can provide a low-cost maintenance diet for cattle and sheep.

Urea is a nitrogen compound that can be used in ruminant feeding. Treating straw with urea provides the microbes in the rumen with the nitrogen they need to grow and multiply and break down the straw more quickly.

The result is that the straw is digested more rapidly, thereby increasing appetite and allowing the animal to eat more.

Like any new feed, animals will take between 3 and 7 days to adjust to eating the urea-treated straw which will smell different to untreated straw. Compared with sheep, cattle adjust very quickly to treated straw.

FEEDTEST* results have shown that treating straw with urea can increase protein levels from 2-14%. The metabolisable energy value of the straw however, is not improved by treatment with urea. To provide the extra energy it is therefore important to continue a low level of grain feeding.



Urea-treated straw being fed out in hay racks

How to treat the straw

Treated straw is obtained by the addition of 5% weight to weight (w/w) of urea plus 80-85% w/w water. So, to treat 1 tonne of straw, 50kg of urea fertiliser needs to be dissolved in approximately 800-850 litres of water. The solution should be mixed in a large container such as a drum or an old water tank and sprayed onto the straw using a pressure pump and hose.

A big square bale weighing 400kg will need 20kg of urea dissolved in 320-340 litres of water.

After spraying, it is critical that the treated straw is contained in a reasonably airtight condition (for example, covered in polythene or old bunker tarpaulin) to facilitate the chemical reaction/treatment process. The straw should be kept covered for 7-10 days in the summer months or 2-3 weeks in winter after treatment.



Urea-treated straw covered with old bunker tarp for 7-10 days in summer

Urea-treated straw is non toxic

The urea on treated straw is non toxic. Urea is only toxic to animals if they drink the urea solution or if they consume a mouthful of urea granules.

When urea is diluted with water at the rates recommended and sprayed over straw in the method described here, the risks are eliminated.

Urea poisoning can occur with malfunctioning of liquid urea feeders or with home-made urea blocks. After rain or heavy dew the blocks may become soft and stock are then able to eat them too quickly and consume too much.

Molasses

Molasses has a good level of energy (11 MJ ME) but is very low in protein.

Molasses can be added to the urea-water mixes and sprayed on poor quality straw to improve both palatability and protein levels when straw is the main component of a diet.

When molasses is added in quantities, up to 12% of total DM, the sugars in the molasses assist with the digestion of fibre.

Molasses has a couple of other uses in cattle diets.

The first is in feedlot rations where it is added at levels up to 12-14%. This level of molasses increases the palatability, binds fine dust particles and assists with rumen function.

The energy value of cane molasses decreases rapidly when it is added at levels above 30% of the total ration. Too much molasses causes digestive upsets and reduces animal performance.

Another use for molasses is as a carrier for feeding urea. Urea-molasses products come in block or liquid form and can be bought or home made.

The nitrogen in urea assists animals to digest very fibrous feeds such as standing dry paddock feed. The sugars in the molasses can also assist in this digestion.

Economics of molasses feeding

In general, in Victoria, molasses is an expensive form of energy. Animal performance would be higher and achieved more economically if grain or pellets were fed with poor quality roughage instead of molasses.

knowledge of a dam's capacity to hold water is necessary to accurately estimate how long your dam water will last. More depth may need to be taken off to account for this seepage.

Example: = 1600m³ less 25% after allowance for evaporation and seepage

= 1200m³

Calculate amount in litres

Multiply volume in m³ by 1000 to get litres

Example: 1200m³ x 1000 = 1 200 000L

STEP 4

How much will stock drink?

Use Table 14 to calculate the daily requirements of all animals that rely on the dam for their water.

a) Calculate the daily intake of the animals

Example: 200 spring-calving cows consuming 100 litres a day will consume 20 000 litres per day.

b) Divide the total dam capacity by the daily water usage

Example: 1 200 000 litres ÷ 20 000 litres = 60 days of water available.

Water quality

Salt content

Evaporation concentrates the level of salt in a dam. During a drought year, low water levels can result in doubling of salt concentrations over the summer.

Table 15 lists salt levels in drinking water that can be tolerated by various classes of stock. In general, the salt content of water should not exceed 10,000 ppm and the magnesium level should not exceed 600 ppm.

Water samples can be tested for salt content at your local Department of Primary Industries office.

Pollution

During the 1982-1983 drought, many dams in northern Victoria were severely polluted by manure and dried vegetation blowing from bare paddocks. The water turned black and gave off a putrid smell. Stock stopped drinking.

Even though after 3 or 4 days of considerable stress most started drinking again, it is thought that for sheep tender fleeces resulted in some cases.

Retention of ground cover on paddocks adjacent to dams will avoid this problem developing.

Algal blooms

Algal blooms are common over summer months when water temperatures rise as dams get shallow and the levels of phosphorus and nitrogen in the water build up.

Most algal blooms are not toxic. Some blue-green algae however, produce toxins which can have serious health implications for humans, animals and birds drinking or coming in contact with the water. It can kill animals within a few hours of ingestion.

Blue-green algae forms a scum which looks like green acrylic paint and leaves sky blue marks on rocks or plants around the edge of the dam.

If you suspect that you have a blue-green algal bloom:

- isolate all stock from the dam or water supply
- collect a sample for testing by a water laboratory (use gloves, don't allow the water to come in contact with skin)
- contact a veterinarian if animals show symptoms of poisoning (loss of appetite, breathing difficulties, muscle twitches, weakness, scours, photosensitisation – any white areas of skin become swollen and reddish)
- contact the Department of Primary Industries for further advice on controlling the algal bloom.

What options are available to reduce water requirements?

Reducing stock numbers

A key issue for any drought period is the number of stock kept on the property. If you are running too many then vegetative cover will drop to critical levels.

What are your core stock numbers? How many do you want to keep? How many do you need to keep? How many can you afford to keep? Can you agist some?

Table 15. Salt tolerance in drinking water for various classes of cattle presented as parts per million (ppm) and units of electrical conductivity (EC units)

Water category	Classes of stock	Total soluble salts (ppm)	Magnesium (ppm)	EC units
1.	Suitable for cattle of all ages	Less than 3200	Less than 400	Less than 5000
2.	Generally unsuitable for calves and weaner stock if unaccustomed. Suitable for dry, mature cattle	3200-6400	Less than 600	5000-10,000
3.	Caution needed with cattle if unaccustomed	6400-9600	Less than 600	10,000-15,000
4.	Generally unsuitable for all cattle	More than 9600	Any level	More than 15,000
5.	Generally unsuitable for all cattle	More than 9600	More than 600	Any level

Relocating stock

Perhaps stock could be confined in a relatively small and safe area with water and feed delivered to them rather than having them chase it. There are advantages of soil protection with this approach.

Minimising evaporation

To conserve water and maintain good water quality, one large deep dam is better than numerous shallow dams.

Hence, depending on dam location etc., it may be advantageous to pump the contents of a number of smaller dams into a single dam to minimise evaporative loss and save water.

Reticulating from dams rather than allowing animals direct access

Reticulating from dams avoids pugging and bogging problems and allows a more efficient use of the water. Reticulation systems however, must be simple, reliable and have sufficient capacity to meet peak demands. Schemes should include troughs.

Site troughs, tanks and pipes to suit future needs, where at all possible.

Protecting dams from wind-born contamination

Keep adequate ground cover on the paddock to prevent material blowing into the dam in the first place.

If ground cover is already low, fencing can be used to trap blowing material before it reaches the water. A closed-wired fence on the windward side is a worthwhile investment.

Once material is in the dam, aeration of the water is necessary to improve its condition and make it more acceptable to stock. This is best done by pumping to a tank and reticulating to a trough. If aerated water is returned to the dam then the organisms growing on the organic material will quickly remove all the air again.

Actions to address a water shortage

Carting water

Carting water is an extremely labour intensive operation. For valuable stock it is presumably a valid option but otherwise it is best regarded as a last resort.

Check the quality of the water supply available for carting. Many streams and bores are quite salty.

Seepage and evaporation means it is not feasible to put carted water into an earthen dam – use tanks and reticulate to troughs.

Sinking bores

Investigate likely water yields and likely quality before drilling emergency bores.

Digging new dams

Do not bother when soil moisture is low. Only build earth dams when soil is moist enough for maximum compaction.

When seasonal conditions improve

Build up a contingency plan for the next dry period. Drought proof your property and its enterprises. Do not get caught by the next dry period.

Chapter 7

Feeding grain to cattle

Grain is a common supplementary feed for cattle during a drought. In comparison to hay, higher energy and protein levels make it an attractive supplement for animals that have higher nutritional requirements, such as young growing stock or cows and calves.

Although there are some risks when feeding grain to cattle, in general, the benefits far outweigh the risks, which are generally minimised by careful management.

Introducing cattle to grain

Take care when introducing cattle to a grain ration to avoid potential grain sickness (acidosis).

Grain contains high carbohydrate levels and should be introduced gradually into a diet so that the bacteria in the animal's rumen have time to adapt to the new feed. Shy feeders and younger animals may need to be separated from more dominant animals to reduce uneven consumption.

Cattle should be accustomed to being fed with hay before grain is introduced to the ration. The hay can then be phased out over 2-3 weeks, as the amount of grain in the ration is increased. Importantly, roughage (hay, straw or dry pasture) should always make up 30% of the ration.

Where there is some roughage left in the paddock, the amount of hay in the ration can be reduced accordingly. Once paddock roughage is depleted however, some hay will have to be fed.

Introduce grain by feeding 0.5kg per head per day. Maintain this amount until all cattle are consuming some grain (1-3 days). During the initial feeding, place the grain on top of the hay to ensure animals consume some roughage.

Increase the amount of grain in the diet by 0.5kg per head every second day until the desired amount in the ration is reached.

Observe cattle closely for sickness and other health problems when feeding grain, particularly during the introductory phase. Cattle scouring or going off their feed are signs of grain sickness (acidosis). Badly affected animals should be removed and fed a hay-

only diet until they appear healthy. These animals should be re-introduced to grain using the same principles applied during the initial introduction.

Seek veterinary treatment if cattle show signs of acute grain poisoning.

Frequency of feeding

Feed cattle daily during the build-up of grain rations. As soon as cattle are on a full ration and accustomed to eating grain, feed every second day (ensuring that twice the daily quantity is fed every second day).

Experience has shown that feeding every two days is about the longest feeding interval feasible.

Early weaned animals in poor condition or animals being fed for weight gain should be fed daily.

How to feed – trough or on the ground?

It is best to feed grain in troughs to prevent wastage and minimise intake of soil. Various forms of troughs can be improvised. For example, two rows of logs placed on the ground about 450-600mm apart joined with old corrugated iron as flooring. Other options include 200-litre drums split down the middle or tractor tyres cut in half.

If the grain is fed out on the ground, this is best done by placing the grain in heaps rather than trailing it out as for sheep.

Feeding processed grain (rolled or crushed) on the ground is not recommended, as too much is likely to be wasted.

Changing a ration

Particular care should be taken when changing batches (or sources) of grain. The new batch should be introduced by 'shandying' with the old batch for about a week. If this is not possible, the amount of grain fed from the new batch should be halved and gradually increased by 0.5kg per head per day.

Grain sickness

Grain sickness, also known as grain poisoning or acidosis, is the main problem associated with feeding grain to cattle.

Grain sickness occurs when the sugars and starch in a feed cause a rapid accumulation of acid in the rumen and/or hindgut. If the acid

accumulates faster than the body can handle there will be reduced rumen function and potentially a loss of important rumen bacteria. Severe acidosis will result in death, while mild acidosis will cause sickness and a loss of production.

The type and treatment of grain will influence its potential to cause grain sickness. Whole grain is less likely to cause grain sickness than processed (crushed or rolled grain) of the same type, such as barley. Coarsely crushed grain is less likely to cause grain sickness than finely crushed grain. Fibrous grains, such as oats, are safer to feed than grains with little fibre, such as wheat. A FEEDTEST* will indicate the level of fibre a ration or feed contains.

Precautions against grain sickness

A number of measures can be taken in addition to the controlled introduction of grain into a ration to minimise the threat of grain sickness.

Buffers

Buffers are chemicals that counter the acidity of grain and help to prevent grain sickness. To reduce the risk of grain sickness during the introductory period, add 2% (2kg per 100kg of grain) of either sodium bicarbonate or sodium bentonite to the grain being fed out with roughage. After one month of feeding grain, the amount of buffer can be reduced to 1%.

Roughage

Roughage (dry paddock feed, hay, straw, etc.) is a key ingredient in drought rations for both rumen function and to minimise grain sickness. At least 30% (or a minimum of 0.5kg/animal/day) of a ration should consist of roughage to enable desired performance.

When grain is the source of energy and protein in a diet, roughage need not be of a high quality. Often straw and low quality hay will suffice. Around 30% neutral detergent fibre (NDF) is an ideal amount of fibre in a diet. The NDF level of a ration can be determined from FEEDTEST*. More information on FEEDTEST* can be found in Chapter 15.

Other grain additives

Where grain contributes to the majority of an animal's daily ration, 1% (1 kg per 100kg of grain) of ground agricultural limestone should be added to the ration. This makes up for a shortage of calcium in the grain.

For lactating or young animals on grain rations, 1% (1 kg per 100kg of grain) of common salt (sodium chloride) should be added to correct a potential sodium deficiency.

Processing of grain

Feeding processed (cracked or rolled) grain to cattle has significant benefits compared to whole grain. Table 16 illustrates the impact of processing on the digestibility of wheat, barley, maize and sorghum. Note that for sheep, virtually no improvement in digestibility is gained by processing grain.

Increasing digestibility is desirable because it increases the grain's potential as a foodstuff. A kilogram of processed grain will provide more energy to an animal than a kilogram of whole grain.

Table 16. Digestibility of whole vs processed grain

	Whole	Processed	Increased digestibility from processing
Wheat, Triticale	63	86	36%
Barley	53	85	60%
Oats	77	81	5%
Lupins, Peas	76	86	13%

Table 16 demonstrates that by processing wheat the digestibility is increased by 36%. This in turn increases the metabolisable energy (ME) levels from 9 for whole wheat to 13 for processed wheat (refer to Table 7).

Deciding whether or not to process grain for cattle depends on several factors:

- the grain used. Processing markedly increases the digestibility of wheat and barley, whereas the digestibility of oats and lupins is only slightly increased
- the availability of equipment to process grain and at what cost. The coarse crush achieved with a roller mill is superior to the dusty result from a hammermill
- ease of feeding. Whole grain can be fed on the ground, crushed grain should be fed in troughs
- grain sickness. Where grain is fed separately from roughage, whole grain is considerably safer to feed than crushed grain. When grain is mixed with chopped roughage however, crushed grain can be fed more safely.

All grains can be fed quite successfully to cattle. Wheat is the most readily available grain for feeding during droughts and, provided that care is taken when introducing cattle to grain, it is a very effective supplementary feed.

Grain feeding problems

In previous droughts, large numbers of cattle have been successfully fed on grain for prolonged periods. Some of the more common problems which can occur are listed below

Grain poisoning – the build up of high levels of lactic acid in the animal can result from:

- introducing cattle too quickly to high levels of grain, or feeding too much grain too soon
- insufficient trough space or feed area resulting in aggressive cows overeating
- changing from a lower energy grain to one of higher energy (for example, changing from oats at 10ME to wheat at 13ME, is a 30% increase in carbohydrate). Sometimes different batches of the same type of feed will cause problems
- feeding pellets in the belief that they are not grain. Pellets are usually 90% processed grain, and the same precautions should be taken when introducing them to cattle
- insufficient roughage fed with grain
- accidents – storage areas are not sealed to prevent stock access.

Treatment for grain poisoning depends on the severity of the symptoms shown:

- mild lactic acidosis – still eating, mild bloat, with or without porridgy faeces
- moderate to severe lactic acidosis – not eating, porridgy scours, obviously sick with dehydration evident
- severe lactic acidosis – down and unable to rise, dehydration, watery scour.

Treatment of grain poisoning may involve range of treatments:

- mild lactic acidosis may simply require removal of grain feeding, a drench with 120g of sodium bicarbonate orally and hay feeding only

- severe acidosis will require intensive veterinary attention. In these cases contact your local veterinarian
- as with many animal health issues, prevention is better than cure. By adding a buffer such as sodium bentonite to a grain-based ration, the potential to get grain poisoning is reduced (refer to Chapter 7, Feeding Grain to Cattle).

Calcium deficiency – Grain feeding over a prolonged period can result in calcium deficiency due to low calcium and high phosphorus levels in grain. This is overcome by the addition of ground limestone to the feed (up to 1.5% of the ration by weight.)

Vitamin A deficiency can occur after a prolonged shortage of green feed. This is unusual in Southern Australia as the liver has the capacity to store sufficient Vitamin A to satisfy animal requirements for at least six months. A Vitamin A, D and E injection can be given to prevent this problem.

Urolithiasis (bladder and urinary stones) can be a problem in steers fed grain for long periods. Addition of ground limestone balances the excessive phosphorous levels likely to predispose cattle to this condition. Adding 1% salt to the ration will encourage higher water consumption thus reducing the risk of urolithiasis problems.

Polioencephalomalacia (PEM) occurs due to an induced deficiency in thiamine (vitamin B1). It can occur in feedlot cattle and cattle on high-concentrate diets, especially when minimal roughage is available. Typical signs include blindness, aimless wandering and a 'star gazing' appearance. Producers should seek veterinary attention for diagnosis and treatment.

Chapter 8

Animal health and welfare

If you have any concerns about the health and welfare of your stock during a drought, please contact your local veterinarian or the Department of Primary Industries District Veterinary Officer.

Health and welfare problems in beef herds in a drought

Droughts, by definition, inevitably result in less than adequate amounts of paddock feed. The effects of this shortfall on health will depend on the class of livestock (for example, steers versus pregnant cattle), the body condition of the cattle as they enter a period of drought and the length of time over which the shortfall occurs.

Class of livestock affected

Breeding stock

Inadequate nutrition can have its greatest effect on breeding stock. Cows in late pregnancy should receive priority in feeding programs as the growing foetus greatly increases the cow's food energy requirements. The cow will give the foetus priority and two distinctly different problems can occur.

The fat pregnant cow, encountering an energy deficiency, will use its own body fat to supply this energy. This will work for a short time, but if the energy shortfall continues, the cow will suffer with pregnancy toxæmia or ketosis. A sudden decrease in energy in a heavily pregnant cow can lead to pregnancy toxæmia, whereas a more gradual or chronic decrease in energy can predispose the cow to ketosis.

In both conditions the liver becomes blocked by the mobilised fat and the cow becomes sick due to liver failure and the effect of the breakdown products of the fat. Cows become staggy and go down, are unable to rise, refuse to eat or drink and eventually die. Prevention by supplementary feeding is preferable to treatment, which is often unsuccessful.

The light-conditioned pregnant cow, encountering a drought, will continue to lose condition, become weak and go down. Compared to the cow affected with pregnancy toxæmia, this cow is not sick, but just

physically lacks the strength to rise. Attention should be paid to feeding cows in early to mid-pregnancy, this type of cow will become a real problem with this condition if the drought extends to their last three months of pregnancy.

The two most important factors affecting pregnancy rates in cows are body fat score at calving and the level of nutrition after calving.

It is a good management practice when pregnancy testing, to request your veterinarian to identify cows expected to be early and late calvers (this will require testing to be done approximately 6 weeks after the end of joining).

In times of drought, early calvers have higher conception rates in the following joining, than do late calvers. If the late calvers are identified, it is possible to preferentially feed them to improve their body condition score at calving and consequently increase their conception rates, or sell them.

Similarly, bull fertility is related to body condition. Semen quality is determined approximately 2 months before use, so it is essential to maintain bulls in good body condition well before mating starts.

Dry stock

Dry stock have the lowest feed requirement and should not be overfed at the expense of breeding stock.

Grain feeding problems

There are many advantages to of using grain to feed cattle in drought, however there are also some potential animal health problems, these are listed in Chapter 7.

Poisoning and chemical residues

Poisoning can be a problem as hungry animals will eat plants they would not normally eat, for example bracken fern and eat other poisons, for example arsenic and lead, in their pursuit of feed.

Care should be taken with garden trimmings, which are often poisonous, and lawn clippings with organochlorine (for example, heptachlor, chlordane), as these may result in unacceptable residues in meat at slaughter. Refer to Chapter 4 for information on chemical residues.

Hungry stock, including transported or yarded cattle, should be fed some hay prior to release onto a fresh paddock or 'failed' crop to minimise the risk of some poisonings and photosensitisation.

Urea poisoning

Urea is a useful supply of non-protein nitrogen for the rumen microbes but care must be taken when supplementary feeding. Poisoning occurs when excess urea is consumed for example:

- as a result of inadequate mixing of feed or roller drum mixes
- when lick blocks crumble or develop a dish from licking which can hold rain water and dissolve urea.

Signs of toxicity include abdominal pain, shivering, salivation, bloat and death. Treatment is oral vinegar – 4 litres for an adult beast.

The effect of disease on drought-affected cattle

Conditions which afflict normal cattle have more serious effect on cattle in poor body condition.

Internal parasites (worm and fluke)

Those classes of cattle which may not normally be treated, for example mature cows which are not normally worm drenched, may need treatment during feed shortages. An increase in the rate of pick up of larvae and the reduced nutrition of the stock can increase susceptibility to the effects of a parasite burden.

By the time the normal symptoms of scouring are visible, severe damage to the animal gut has already occurred, adding to the problems of an animal already under nutritional stress.

Severe parasite burdens will reduce the effectiveness of an expensive feeding program during drought times. The basis for an appropriate program during dry times is monitoring for worm burdens and effective drenching as required. See your local animal health adviser for more advice.

Lice

Cattle lice seem to have a worse effect on appearance of cattle when they are in poor condition. The amount of damage to hides, trees, fences, gates and troughs is proportional

to the number of lice. Cattle lice numbers build up in the cooler months reaching a peak toward the end of winter.

Bottlejaw

Bottlejaw, which is normally associated with liver fluke, can also occur in worm-infested stock and stock in poor condition (due to low blood protein).

Coccidiosis

Coccidiosis is another disease that can occur in cattle under stress and congregating to be hand fed. Severe scouring of blood-stained faeces will occur. This condition is normally seen in younger classes of stock.

Pulpy kidney (Enterotoxaemia)

Pulpy kidney is an acute toxæmia caused by Clostridial bacteria in the intestine. A change of diet and thus a slowing down of the movement of food through the gut, such as grain feeding, lot feeding, periods of time off feed when yarding and transporting, provides the ideal environment for pulpy kidney to occur.

Cattle under 2-3 years old are most susceptible to pulpy kidney. Generally, the best conditioned, fastest growing stock are the ones most likely to develop pulpy kidney. There is no practical treatment, and most affected stock will die.

The disease can be prevented by vaccination. Previously vaccinated stock should be given a pulpy kidney or 5 in 1 booster two weeks before the start of hand feeding, or before a major change in feed type. Unvaccinated stock requires two doses – six weeks and two weeks before starting to feed. Pregnant cows should have a booster about two weeks before calving is expected to start. This will protect the calf for six to eight weeks. Calves need two vaccinations – one at marking, and the second about four weeks later.

In high-risk circumstances, vaccine protection may only last for three months, so repeated vaccination should be considered.

Pneumonia and calf diphtheria

Nutritionally stressed stock and early weaned calves are more susceptible to respiratory diseases including pneumonia and calf diphtheria. These diseases can be exacerbated when stock congregate around feed troughs. Veterinary attention should be sought if you suspect any disease.

Pinkeye

Pinkeye can be a greater problem in drought, with increased dust and stock congregating around feed troughs.

Welfare considerations of drought

The welfare of animals is always of the utmost importance.

Stock owners and managers have an obligation to, at all times, provide proper and sufficient food, water and shelter for stock under their care. Failure to do so contravenes the *Prevention of Cruelty to Animals Act* and may result in severe fines or even imprisonment.

Where sufficient food and/or water requirements cannot be met, cattle should be moved or agisted to a place where feed and water is sufficient or they should be sold or humanely slaughtered.

Producers should act early while stock are fit and strong, as delays usually reduce the number of choices available. Any decisions must be humane and reasonable.

Chapter 9

Feeding in stock containment areas

Stock containment areas are yarded locations where stock are lot fed for survival or maintenance on a full ration. Stock containment areas enable cattle to be removed from susceptible paddocks. Placing cattle in stock confinement areas reduces erosion and gives pastures a chance of surviving the drought.

Stock containment areas are similar to feedlots except that they require less infrastructure and are deemed more short term. Lot feeding is a separate issue and is covered in Chapter 12.

When to use a stock containment area

During a drought there is a high risk of losing valuable soil as pasture cover reduces. If pasture cover is reduced below about 70%, wind will start to blow away soil particles, causing erosion and loss of valuable nutrients and topsoil. Bare areas will also be more prone to washing, when rain does come.

Once stock have been removed, ground cover is likely to decrease further as a result of wind erosion, particularly in pastures dominated by annual species. It is important, therefore, to remove stock while around 70% ground cover still remains.

Before deciding when to remove stock from pastures, you should consider a number of factors which will affect potential pasture loss and erosion, such as slope and soil type.

Improved pastures are also very vulnerable to overgrazing. Pastures established after considerable investment of money and time are easily lost if continuously overgrazed. Improved pastures should be among the first paddocks you consider de-stocking.



80% ground cover



70% ground cover. Remove stock before this point. At 70%, the bare patches are quite large and are starting to join up, creating opportunities for soil movement



A paddock that has been grazed below 70% ground cover. A light wind removes considerable topsoil. Do not let this happen to your paddocks!

Feeding in stock-containment areas should be considered :

- to protect vegetative cover on pastures or failed crops, and to allow pastures to recover rapidly after the break
- where weeds in purchased feed are a concern
- to protect areas vulnerable to erosion
- where stock are losing weight on full drought rations in paddocks
- to facilitate stock feeding, watering, monitoring and handling.

The location of the site is important. The site should have:

- a moderate slope and well-drained, stable soil such as a clay or clay loam
- ready access to the house
- no important remnant vegetation
- shade, shelter and good drainage
- access to good quality water and clean facilities
- minimal problems with noise and smell that will cause concern to you or your neighbours.

Consider water quality in terms of runoff. The stock containment area should be set back from watercourses and water storages by 500 metres, if no other management methods are used. As an alternative, a nutrient filter (below) should be established on the down slope side of the site to prevent runoff.



Nutrient filter to prevent contamination of watercourses or storages

Space requirements

Adult cows, yearlings and early weaned calves should all be yarded and fed separately because of their different feed requirements. Allow 10-15m² per head. Stocking heavier

rather than lighter has the advantage of increasing soil compaction in the containment area to reduce dust, particularly on lighter soils.

If you are considering containing more than one group, you will need good subdivisional fencing as well as boundary fencing. Consider a separate yard for the grain feeding troughs as this will allow you to mix feeds and additives before stock start to eat.

One feeding yard (with separate holding yards) can be used for the different classes of stock if they can be fed at different times. This can reduce the need for extra feeding troughs. You will also need to consider access of vehicles, ease of filling feed troughs, water and ease of cleaning. Monitoring stock is extremely important and you may also consider ways of weighing or monitoring a group fortnightly.

If there are trees in the area you propose to use, protect these with guards or they will be ringbarked.

Water

A good reliable water supply is extremely important in stock containment areas. Generally stock will be fed diets very low in water content and must therefore be supplied with water at all times.

Maximum desirable salt and magnesium levels for stock water are given in Table 15.

Bore water should also be tested for toxic minerals such as magnesium.

When budgeting on a water allowance, plan for a daily consumption of 55L/head/day for weaners and up to 100L/hd/day for lactating cows. Trough space is less important than flow rate. Water trough allowance does not need to be more than required in a paddock – cattle will adjust and take turns to drink at the trough. A good rule of thumb is that the flow rate should pump enough water for the mob in 2 or 3 hours.

Troughs need to be checked daily and cleaned regularly.

Feed

Allow 400-600 mm of trough space per animal.

Feed troughs can be bought or made cheaply from materials like tractor tyres cut in half or 200L drums split down the middle. Two rows of logs can be placed on the ground about 450-600mm apart and joined with old corrugated iron as the flooring.

Quantities for full hand feeding (kg/hd/day) for common classes of stock are provided in Table 13. If stock are to gain weight, these quantities would need to be increased by 20-30%.

As stock will not have access to any pasture, inclusion of roughage is important. Ideally, 30% hay should be included but, as hay can be very expensive and often simply not available during drought, the proportion can be reduced to an absolute minimum of 20%. Hay in the diet will reduce the risk of grain poisoning, especially with grains of low fibre content such as wheat and barley. Oats has about 29% Neutral Detergent Fibre (NDF), compared to barley at 14% NDF and wheat at only 11% NDF.

Hay is also the safest way to increase energy quickly in cold or wet conditions.

As outlined in Chapter 7, the deficiencies likely to occur with high grain diets during drought or lot feeding are sodium, calcium, fibre and Vitamin A. Adding 2% feed-grade sodium bicarbonate or sodium bentonite for the first month and 1% after that will lessen the risk of acidosis. In addition, 1% feed-grade limestone to provide calcium and 0.5% salt to provide sodium will be required.

It is better to start cattle on grain in the paddock before introducing them to a feedlot situation (two weeks). If you cannot do this, make sure that most of the diet in the first two weeks is hay and then increase the grain ration gradually. Start at 0.5kg/head/day of grain and make up the rest of the ration with hay. Increase the amount of grain by 0.5kg/hd/day every 2 days until the desired level of grain is reached. Feed your best hay first and feed hay before grain. Feed daily. For more detail, see Chapter 7 Feeding Grain to Cattle.

It may take a while to get the ration right and, as the cost of feed is especially high during a drought, consider weighing 20 or so cattle regularly. Over and under feeding is costly. Aim to keep older stock at a minimum fat score 2.

There will always be a number of cattle that do not take to a lot feeding situation and these should be identified early, removed and fed hay or sold.

Stressful weather conditions

Cold windy weather will increase the cattle's need for energy-giving feed that will maintain the animals. Under such conditions drought

ration should be increased by about 20%. The increase should be made up with roughage (hay) if possible. Replace with new feed any feed wasted as a result of rain damage.

Releasing cattle

When the drought does break, the change in feed from grain and hay to short green grass can be quite sudden and is likely to cause digestive problems. If the break is accompanied by cold, wet windy weather then this may reduce an animal's inclination to graze thus reducing intake further. Release cattle from the containment area when they have a full stomach and then continue to feed for a few weeks, gradually reducing the quantity of feed.

Remember, ruminants do best when their diets are changed gradually. A sudden change from a grain diet to short green feed will result in digestive upsets and weight loss as their rumen adjusts to the new feed. Cows below fat score 3 with young calves have high feed requirements and may need feeding (both hay and grain) to continue until there is adequate pasture available to meet their needs.

Pastures are likely to recover faster and provide more winter feed if they are allowed to produce some leaf area before the first grazing. See Chapter 13 for information on pasture recovery after a drought.

Animal health

Health issues during droughts are outlined in Chapter 7. Experiences with stock containment areas have shown that grain poisoning is the most common cause of death. For more information on how to prevent grain poisoning refer to Chapters 7 & 8.

Problems have been experienced with changes in batches of processed feeds and with new sources of grain. Some caution should be taken, therefore, when changing to a new load of feed, such as mixing the new and old over a number of feeds. This is often not very practical. When a new batch of grain is being introduced, cut back the quantity and gradually increase to enable the animals to get used to it.

Cattle should receive a booster vaccination against clostridial diseases such as enterotoxaemia (pulpy kidney) at least 3 weeks before entering the containment area.

Vaccines such as 5-in-1 or 7-in-1 can be used. Talk to your vet about the most appropriate vaccine for your district. Remember, cattle that have not been vaccinated before require two vaccinations four weeks apart to provide protection, then an annual booster. They should be drenched into the area and ideally drenched before being released.

Stock need to be monitored daily and sick animals removed. Avoiding stress such as boggy ground, overcrowding, dust and irregular feeding will help reduce diseases such as Salmonellosis, Coccidiosis, pinkeye and respiratory diseases such as pneumonia. Regular cleaning of feed and water troughs will also prevent diseases.

General

Farmers who fed in containment areas in previous droughts reported that it was a very worthwhile exercise and have now made it part of their future drought management strategies. Managing a stock containment area however, involves a transition from a broad-acre manager to an intensive manager. Because all the feed and water is supplied by you, constant vigilance and good management is required. It also means you can have better control over weight loss and gain and come out of a drought with valuable land assets and stock numbers intact.

Further information is available in the Department of Primary Industries (DPI) Notes and Information Series, available from DPI offices or the DPI website at www.dpi.vic.gov.au.

Chapter 10

Early weaning of beef calves

Early weaning is a strategy worth considering to deal with a feed and water shortage.

If feeding grain to early weaned calves, you should review the information in Chapter 7.

Key reasons for early weaning

Maintain herd fertility

Early weaning helps beef producers to maintain cow fat score and therefore fertility of their breeding herd during and after a drought. For example, by weaning Spring calving herds before cows fall below fat score of 3 will mean they only need maintaining to calving for acceptable post-calving return (interval) to oestrus and conception rates. Cows down in condition are more likely to cycle and conceive sooner after calving, if the calves are weaned prior to joining.

Save your pasture

It is more efficient to convert feed directly into calf weight than milk for a cow and calf pair. Weaning early will reduce the dry sheep equivalent demand on your property. When combined with feeding appropriate quality and quantity of feed to dry cows and weaned calves, rather than cows with calves at foot, significant feeding cost reductions can result.

Cows that have had their calves weaned early can be shifted to more marginal country so only 'growing' stock is run in the best paddocks.

Cows will need less feeding later on because they will have lower weight loss once calves are weaned.

Better utilise supplementary feed

Buying supplementary feed during a drought is a costly experience. Early weaning will enable you to better allocate supplements to different classes of animals. High energy and protein feeds can be fed to young growing stock, and lower quality feeds (that is, poorer quality hay) to the dry cows. This will reduce the overall cost of supplements during the drought.

Save water

Early weaning can reduce water requirements of cows by up to 60%. Lactating cows require up to 100 litres per day. Although a calf's water intake approximately doubles when it is weaned and no longer getting liquid via its mother's milk, there is a significant net saving in water from early weaning.

Sell cull females earlier

Early weaning will enable earlier pregnancy testing and mousing and the sale of non-productive, cull or aged animals.

Age of weaning

In most cases it is preferable to wait and wean calves at 12 weeks old or around 100kg, because they will then require less protein and be easier to feed.

However, calves can be weaned onto high quality dry rations at five weeks of age or around 50kg.

If cow survival is of concern, calves can be weaned earlier than this, but a milk replacer will be required if calves aren't going to be sold as bobby calves.

In a drought, all calves older than five to six months should certainly be weaned and fed separately.

Deciding when to wean

Cow condition is a major consideration when deciding when to wean. Wean early in order to maintain cow herd productivity.

The appearance of calves should also be considered. Calves with dry, coarse coats (woody calves) are almost certainly not receiving adequate milk from their mothers. Early weaning is the best policy in this situation. Calves with glossy coats are receiving an adequate diet and early weaning can be delayed.

Pre-weaning

Expose calves to the post-weaning supplement while they are still on the cow. For example, if calves are going to be given silage post-weaning, feed silage to the cow-calf mobs a few times.

Rumen microbial populations can require up to 14 days to completely adapt to a new diet. Consider introducing calves to post-weaning supplements slowly via creep-feeding two weeks before weaning.

Weaning

Avoid combining stressful procedures like castration and dehorning with early weaning.

If yard weaning, where possible keep the yards damp to minimise pink-eye. Fly traps and backline insecticides will also reduce flies, a vector for the disease. Eye ointments and patches of heavy material will provide relief for affected calves and prevent fly access.

When penning calves allow 4 square metres per calf as a minimum, increasing to 6-8 square metres for larger calves approaching 150kg.

Provide **high quality** hay, such as lucerne hay, and clean water troughs.

The high quality ration required by early weaned calves will increase their risk of developing pulpy kidney so vaccination for clostridial diseases is important.

Post-weaning nutrition

Nutrition, nutrition, nutrition!!! The younger the weaning age of the calf, the higher the energy and protein levels need to be.

The energy and protein requirements of calves at various growth rates are presented in Table 17. Some possible diets for early weaned calves are shown in Table 18.

Unless the feed has adequate energy density, feed intake and animal performance may be restricted by small rumen capacity. Much of the pasture hay and silage made in Australia is by itself unsuitable for early-weaned calves.

Introduce any concentrate, for example grains, slowly. Introduce initially to calves at 300g per head per day and increase the amount by 100g per head per day with access to hay. Supplement the mix with a buffer to prevent acidosis.

Insufficient protein in the ration of early weaned calves will result in short, dumpy cattle. Likely sources of protein to use are lupin grain, peas, linseed meal, canola meal and soybean meal.

Ideally, roughage should be chopped and mixed with the other components of the calves' diet, before feeding. Palatability is important to get calves to eat sufficient fibre. Consider adding a sweetener such as molasses or grape mark to a mixed ration for young calves.

Calcium is the mineral most likely to be needed in a diet for calves. Generally, calcium carbonate (such as ground limestone) should be added to a grain-based diet at the rate of 1½ parts per 100 (that is 1.5%) by weight of the grain in the diet.

Although good quality roughage (lucerne or clover hay) provides a reasonable supply of Vitamin A, some supplementary Vitamin A is usually necessary for early weaned calves if they only have access to a dry ration, and have not had access to green pasture for some time, for example 3 months: This can be included in the feed, given orally, or by injection.

Alternatively, complete rations in the form of pellets are available from commercial suppliers.

Post-weaning management

Rather than letting calves roam barren paddocks, consider weaning into containment areas where they will tend to rest and feed, conserving energy and minimising damage to paddocks. If calves are contained tightly the urine and manure keeps the dust at bay, which will reduce the incidence of pink-eye.

Six weeks after weaning, draft off tail-enders into a separate management group. Repeat this process four months after weaning.

Post-weaning health program

Administer a booster 7-in-1 vaccination. Young calves are vulnerable to worms and so a worm management program is particularly important.

Table 17. Energy and protein requirements of calves of various liveweights

Liveweight (kg)	Growth rate (kg/day)	Maximum daily % of liveweight	Dry matter intake (kg)	Metabolisable energy (ME) requirement (MJ/day)	Minimum ME concentration of diet (MJ/jg DM)	Crude protein percentage of dietary dry matter
50	0	3.2	1.6	14	8.8	12
	0.5	3.2	1.6	23	14.4	18
100	0	3.0	3.0	18	6.0	10
	0.5	3.0	3.0	29	9.7	16
150	0	2.9	4.3	22	5.2*	8
	0.5	2.9	4.3	37	8.7	12
	1.0	2.8	4.3	50	11.6	13
200	0	2.8	5.5	26	4.8*	8
	0.5	2.8	5.5	44	8.0	11
	1.0	2.8	5.5	59	10.7	13

* Calves on these diets may not eat to full appetite because of the very poor quality (low ME values) of those particular diets

Table 18. Some diets for early weaned calves

Diet A	per cent	Diet B	per cent
Barley*	55	Wheat*	65
Lupins	25	Linseed meal	15
Hay	20	Lucerne hay	20

- Plus calcium and a 'buffer'

Chapter 11

Creep feeding of beef calves

For producers wishing to finish spring-born vealers in a late autumn/early winter feed shortage, or facing a severe feed shortage with young autumn-born calves in winter, creep feeding of calves is a management option.

Creep feeding is a very useful management practice that enables beef vealers to be finished for market while still suckling on their mothers. In some seasons, for some types of cattle, creep feeding makes the difference between having vealers prime, or having them unfinished and in only store condition at weaning.

Creep feeding allows unweaned calves to be fed a nutritious supplement (usually grain and some hay), but the supplement is not accessible to the cows. Hence the calves get the best of both worlds – milk from their mothers and extra nutrition from the creep feed.

The aim of creep feeding is to improve liveweight, condition score and the appearance of calves at the time of weaning.

When to consider creep feeding

The best conditions for profitable creep feeding occur when:

- pastures have dried off, or there is not enough feed for the cows and calves in late spring or early summer
- calves are not doing well at four to five months old because their mothers are not milking well
- there is incentive to sell the weaner calves in prime rather than store condition.

When not to consider creep feeding

Do not creep feed when:

- calves are not going to be sold at weaning – such as replacement heifer calves – as they will lose the bloom from creep feeding soon after it is stopped. There is little point in feeding calves to be prime at weaning unless they will be sold
- the pasture season is good. Extra feeding may be a wasted expense when calves are doing well.

The creep enclosure or creep gateway

Creep feeding simply involves a barrier that blocks cows (or adult cattle), but allows calves

(up to 10 months old) to pass through and gain access to better nutrition than is available from grazing on the other side of the barrier.

The better nutrition can be in the form of grain or pellets and some hay available in troughs or self-feeders. Alternatively, the creep may allow calves access to better quality grazing, such as a lucerne stand or irrigated pasture.

Usually creep feeding enclosures are most easily constructed in the corner of a paddock using old gates or steel posts.

Whether the creep feeding allows calves into an enclosure or through into an adjacent paddock, the critical factor is the width of the creep openings that allow the calves, but not the cows, to pass through. The spacings of the openings should be 400-450 mm. Ideally, these vertical spacings should be adjustable, and there should be a number of them.

A gate frame about one metre high, with several adjustable openings, is the most practical arrangement as it can be used either as the entrance to a creep enclosure, or in the gateway that allows calves access to more nutritious grazing.

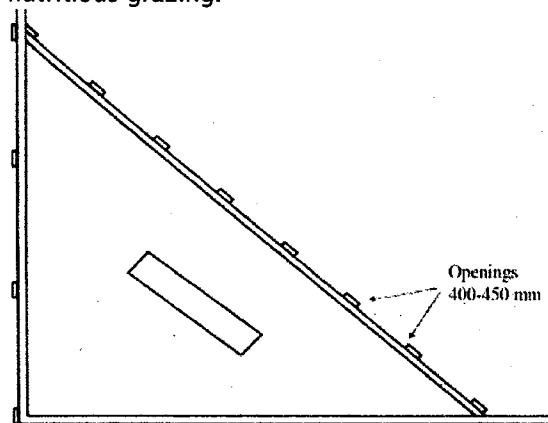

Figure 7. Semi-permanent creep in a paddock corner for supplementary feeding of calves

Feeders

A wide range of self-feeders are available for the feeding of grain, pellets or hay. Alternatively, the feed in the creep can be fed out in troughs. Feeding on the ground will result in considerable wastage.

The best self-feeders are covered and protect the feed from rain. Self-feeders that have an adjustment on the opening between the hopper and the feeding tray also have advantages.

This adjustment enables some control over daily rates of consumption, which can be particularly important in the introductory feeding period. Be aware, however, that these block up regularly and will need daily scraping to keep the feed flowing.

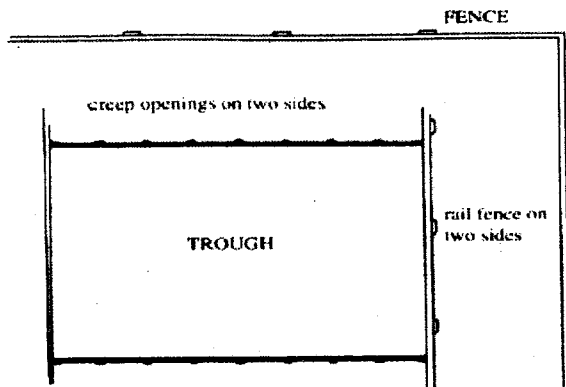

Figure 8. A permanent calf creep is useful where a concentrate ration is fed to calves. The trough should be covered to prevent feed waste from rain

The type and level of feed

Deciding which feed to use should be based on price, availability and convenience. The choices include oats, barley, wheat, triticale, maize, lupins, peas, pellets or a combination of some of these.

Pellets are probably the most convenient and flexible concentrate to feed and are available with a range of protein levels to suit the particular animals being fed and the pasture available at the time. Calves have high protein requirements.

Oats are the safest cereal grain to feed. With the exception of oats, all other grains should be coarsely rolled before feeding to improve their digestibility.

To get the calves used to entering the creep, feed hay only for the first few days – up to a week if need be. Make sure that all the calves are using the creep.

Then start feeding concentrates (grain or pellets) at a level of 250g per calf per day. When most of the calves are feeding in the creep, increase the level of concentrate by 250g every third day. The upper level of feeding will depend on paddock conditions and the weight of the calves but it should be around 2kg per calf per day.

Alternatively, cows and calves can be fed small quantities of grain or pellets in the paddock. In this way the mothers will train their calves to eat the grain. After a couple of weeks the creep system can be put in place and the cows excluded.

When to start

Start creep feeding unweaned beef calves when the cows' milk production falls, usually after six to seven months. If calves have not grown enough by normal weaning time, feeding can be continued in a feedlot. This might be appropriate in a bad spring, or it could be used to improve calves from heifers which are not milking well.

Will it be profitable?

Like any proposed management practice, it is important to do a budget looking at the profitability before commencing.

The financial outcome of creep feeding will be determined by:

- the total cost of the ration
- the extra value achieved through feeding – that is, the difference between the market value of calves at the end of feeding and an estimate of their value at that time if they had not been creep fed.

Chapter 12

Opportunity lotfeeding of beef cattle

An opportunity feedlot is a feedlot that does not operate all year. It is generally used to fatten stock during periods when store prices are low and fat prices are high.

Will it be profitable?

Lotfeeding of beef cattle can make or lose money. It is vital to carefully budget the lotfeeding exercise before starting, to be certain that it will be profitable.

Important factors in the budget are the:

- value of cattle at the start of lotfeeding
- value of cattle at the end of lotfeeding
- cost of feed eaten during lotfeeding
- health costs (drench, vaccine, growth implant, etc.)
- feeding costs (labour, equipment, depreciation).

As a guide, consider the following figures:

- lotfed cattle eat about 2.6-2.8% of their bodyweight daily as feed (a 200kg animal eats 5kg; a 300kg animal eats 7.5kg etc.)
- with careful lotfeeding cattle gain from 1.2-1.5kg a day or better
- cattle require 60-100 days to fatten in a feedlot, depending on their initial condition and the end market specifications.

In round figures, a 250kg steer fed for 100 days might gain 120-150kg liveweight and eat about 800kg of feed.

Obviously there needs to be a big margin between the value of the cattle at the start and finish of the lotfeeding. Furthermore, some type of forward selling system will help guarantee profitability.

Site, facilities, equipment

The main factors to consider in siting the opportunity feedlot include access for moving cattle in and out of the feedlot, and also for the daily feeding of the cattle.

The site should be well drained and sheltered from prevailing winds. Shade can be an advantage. A reliable supply of good quality water is essential.

The feedlot should be securely enclosed with good fencing or rails. The feed troughs should be positioned outside the enclosure so that the cattle eat by reaching through an opening in the fence (see Figure 9). There needs to be 400-600mm of trough space per animal.

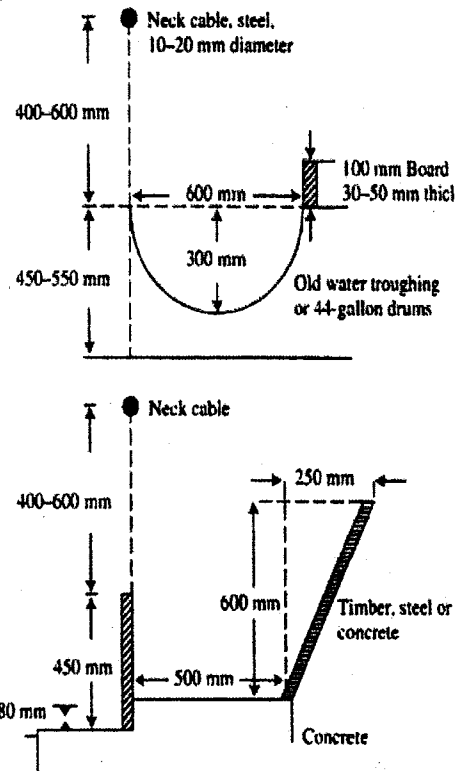

Figure 9. Two designs of feed troughs, situated outside the feedlot. Cattle eat by reaching through an opening in the fence

It is a good idea to make the 'neck' cable or board above the trough adjustable to cater for different classes and sizes of cattle. You can do this by boring holes at various heights in the posts to thread the cable through, or by using a clamp on each post to raise or lower the cable.

The cost of lotfeeding makes liveweight scales essential to ensure that cattle gain weight at the expected rate.

For feed preparation, the ideal equipment has the capacity to roll grain, chop roughage, mix these ingredients and some minerals together, and then feed the mixture out to the cattle. Various machines are available that do some or all of these jobs.

Feeds and feeding

Any feedlot ration should contain roughage (hay or silage), grain and minerals.

The usual procedure is to start the cattle on roughage only for two days. The proportion of grain in the ration is then gradually increased over a number of days. The percentage of grain fed can be increased by 5% every two days. Common practice is to increase the grain level to about 40 or 50% of the ration, and hold at that level for a few weeks. Then increase the grain again to 70 or 80% for the finishing phase.

It is important to observe the cattle closely as the grain level is increased. If there are any signs of digestive problems, the grain level should be held constant or even decreased. Severely affected cattle should be taken to a separate area and fed roughage only.

Barley is the best grain for lotfeeding cattle, but wheat, triticale, sorghum, maize, lupins and oats can also be used. Oats on their own are not an ideal grain for fattening cattle, but they can be used with any of the other grains. Hay or silage can be used as the roughage source. Silage is ideal because it improves the palatability of the ration. If hay and grain are used, the addition of some water can reduce the dustiness of feed and improve overall palatability. Probably 5% water (5 litres of water per 100kg of feed), sprayed in when mixing, will be enough. A dry matter content of 80% for the feed lot ration is ideal.

In some cases, mixtures of barley and lucerne hay can cause cattle to bloat, so that combination should be avoided.

Poor quality roughage, such as straw, can provide up to half of the roughage component of the ration.

Commercial mineral/vitamin premixes are available for adding to feedlot rations. These may contain calcium, urea, sulphur, salt and various trace minerals and vitamins (or just the trace minerals and vitamins) and are usually included at 1-5% of the total ration.

To achieve satisfactory growth rates, the ration should have an overall level of 13% crude protein. If the roughage and/or grain used is low in protein (say the roughage has less than 8% and the grain less than 11% crude protein), then some natural protein should be included in the ration. Lupins, peas, sunflower meal, safflower meal, linseed meal, and soybean meal can be used, probably at about 5% of the total ration.

Growth promotants and rumen manipulators

There are two types of chemicals available that can be well worth using in lotfeeding. The first, growth implants or growth promotants (HGPs) increase cattle growth in feedlots by an average 10-20%. Contact the local Department of Primary Industries office before using HGPs as there are strict requirements associated with their use, including detailed record keeping.

Rumen modifiers are another group of chemicals that, when added to the feed, enable the cattle to use it more efficiently. On average they improve the efficiency of feed conversion by 10%.

The value of processing and mixing feeds

It is possible to successfully fatten cattle simply by feeding them un-chopped (long) hay and unprocessed (whole) grain. The results, however, are usually not very satisfactory.

If possible, roughage should be chopped and the grain coarsely rolled. Rolling improves the digestibility of barley, wheat, sorghum and triticale by 25% and oats by 5%.

For best results, the feed should be well mixed, palatable and balanced for the important minerals as well as protein.

Table 19. Examples of feedlot rations

	Use this ration if protein content of hay/ roughage is adequate	Use this ration if protein content of hay/ roughage is inadequate
	(%)	(%)
Intermediate ration		
Grain	50	45
Roughage	45	45
Protein concentrate	-	5
Minerals/vitamins*	5	5
Total	100	100
Finishing ration		
Grain	75	70
Roughage	20	20
Protein concentrate	-	5
Minerals/vitamins*	5	5
Total	100	100
Minerals/vitamins to be used in rations		
	% of ration	
Limestone	1	
Urea	2	
Salt	0.5	
Gypsum	0.5	
Commercial trace minerals and vitamins	1	
Total	5	

Chapter 13

Stock and pasture management at the end of a drought

Feeding stock at the end of a drought

In previous droughts, some of the worst stock losses have occurred immediately after the drought has broken. It is important, therefore, that the feeding management of sheep and cattle is carefully planned and supervised over the weeks following the end of the drought.

The problem

Following drought-breaking rain, it is natural that stock will look for, and eat, the 'green pick' that quickly appears in the paddocks. There are two problems associated with this behaviour:

- the arrival of drought-breaking winds can be accompanied by cold and windy weather. These conditions place added stress on stock that are already suffering from a lengthy drought. Stock will spend a lot of energy roaming around paddocks chasing the short 'green pick'. Although the 'green pick' is highly nutritious, the quantity that stock can eat soon after germination is not great and may be far less than their maintenance requirements
- just as stock need time to adapt to grain feeding, they also need time to adapt from grain feeding to eating pasture. It takes from two to three weeks for the population of digestive organisms in the rumen of sheep and cattle, to readjust from digesting grain to digesting pasture. Very sudden changes from high grain rations to green pasture can cause digestive disturbances. This warning applies particularly where the pasture contains phalaris. Hungry stock that are allowed unrestricted access to phalaris paddocks are at risk from phalaris poisoning for some time after a break. Ryegrass staggers may also occur (if any perennial ryegrass has survived the drought).

There may be stock problems if the pasture is dominated by particular weeds. Nitrate poisoning is common in pastures dominated by capeweed and clover early in the season. If there is any doubt about the toxicity of a pasture it is wise to graze it with a small mob of sheep for 1-2 weeks before introducing a large number of animals.

Feeding management

Hand feeding should be continued for two or three weeks beyond the end of the drought. If available, roughage, such as bailed hay or even straw, is the most appropriate fodder at this stage.

The stock should be restricted to small areas for the first two or three weeks, to allow most of the farm's pastures to 'get-away'. Stock should be given some access to some 'green-pick' during this period to enable their digestive systems to readjust to the green feed.

Stressful conditions associated with drought-breaking rains increase the maintenance requirements of the stock, so the rations fed over the two to three week period should be increased by about 20% above drought rations.

If no conserved roughage is available and the drought-fed stock have been fed all-grain rations, they should be gradually weaned off grain over about two weeks.

Restrict the stock to fairly small paddocks during this procedure, but make sure there is some green feed present to replace the grain that is gradually being eliminated from their diet.

Other practical considerations

If there are substantial drought-breaking rains, it is possible that hand feeding stock might become very difficult over the two to three-week post-drought period. Paddocks could well become too boggy for vehicles. Stock may use up valuable energy reserves chasing feed in such conditions. Hence, the planning and organisation of feeding management during the immediate post-drought period is critical.

Most droughts end in autumn or winter and this corresponds to a nutritionally demanding time for most breeding sheep and cattle. Lambing and calving occur during autumn or winter on many Victorian farms and the nutritional demands of breeding stock in late pregnancy and early lactation are substantial. This is another reason why the post-drought feeding management of livestock is extremely important.

It is also vital that all stock are treated for internal and external parasites and clostridial diseases before the onset of cold and wet conditions.

Pasture recovery after a drought

The effect of drought on a pasture will depend, to a large degree, on the management and grazing pressure to which it is subjected, relative to the rainfall received during the drought. Experience gained during previous droughts and the experience of pasture specialists throughout the state suggests that there are significant differences between species in their ability to withstand the usually combined effects of heavy grazing pressure and reduced rainfall.

The extent to which pastures recover after a drought depends largely on when the drought-breaking rains are received. If the drought breaks with a 'normal' autumn break, that is, germinating rains in March-April, the pasture should recover quickly – providing there are adequate numbers of viable seeds to germinate or there are drought-tolerant perennial species present. Sufficient follow-up rains are needed to keep pastures growing vigorously. A delayed break, or lower-than-average rainfall in the autumn, would progressively impair pasture recovery rate. The effect of drought on irrigated pastures will depend on the availability and frequency of watering.

Annual species

Because annual grasses, such as annual ryegrass, will have reduced seed set during a drought, fewer are found in pastures in the year after a drought than before or during.

Low seed set, combined with heavy grazing through spring and summer, means less seed is produced and subsequently available for regeneration. The effect is likely to be similar to that of cutting annual grasses for hay.

Lack of competition from favourable species, however, may allow undesirable annual grasses such as silver grass and barley grass to come back strongly even if there is less seed available for germination. This can be controlled with grazing management and spray programs that favour perennial species if they have come back in sufficient numbers.

Sub clover or medic should have sufficient residual hard seed in the soil to produce a good sward after drought unless the clover or medic content has been poor for some years before. Bare soil conditions and an early break will favour their germination and it is not uncommon for these annual legumes to return to a similar or greater percentage of the sward than prior to the drought. Overgrazing during

summer and autumn, however, can result in a significant decline in seed reserves, resulting in lower clover and medic plant densities, and favouring broadleaf weeds.

Annual weedy species such as capeweed, erodium, Patterson's curse and thistles will be more prominent after a drought. These free-seeding broadleaf weeds tend to grow bigger with less competition. If capeweed is dominant, however, there is a possibility of nitrate poisoning of stock. This can be prevented by not introducing hungry stock to capeweed-dominant pastures. Like sub clover, these species are favoured by bare ground at germination and reduced competition from other species. They also cope better with 'false' breaks than other species.

Perennial species

Most perennial grass species are likely to suffer considerable reductions in plant numbers during a drought. This effect will be more severe, the longer the dry conditions last. Perennial ryegrass is the least tolerant of drought, followed by cocksfoot and tall fescue. Phalaris is the outstanding grass in surviving drought, providing valuable feed and minimising soil erosion. A dormant bud in the phalaris plant is its mechanism for survival, supplying the plant with water and nutrients throughout the dry period. By allowing phalaris to set seed in spring, the dormant bud can be fully developed, enhancing the chances of survival. Care should be taken, however, when grazing phalaris pastures soon after the autumn break. Short phalaris pastures can produce a toxin, causing phalaris staggers and death. The risk can be minimised by allowing plants to establish 3 leaves before grazing, and feeding the animals hay before they are introduced to phalaris shortly after the break.

Paspalum is relatively drought tolerant and will increase its dominance in under-irrigated pastures. Lucerne has a deep taproot and can survive drought provided it is given regular spells from grazing to allow it to recover. White clover survival is likely to be severely affected, particularly in marginal areas (which includes 'irrigated' areas where the watering has been stopped).

Feed supply

Given a 'normal' autumn break after the drought, there should be adequate paddock feed within six to eight weeks, despite the botanical changes. Reduced stock numbers in some grazing areas will favour the feed supply situation.

Opportunity to improve pastures

For many farmers there are a number of disincentives to re-sowing pastures after a drought:

- finance for sowing pastures is likely to be limited
- with reduced stocking rates, in some grazing areas there will be no urgency to increase pasture productivity immediately
- availability of locally produced pasture seed may be limited. However there should be adequate seed available from other states or overseas. The price of seed is likely to rise and supply/demand is likely to force prices higher for some time after the drought.

A good weed control program in the year before sowing should precede all pasture establishment methods – droughts are no exception. Although there may be less annual grass seed than usual, it is likely there will still be enough to restrict the germination of a new pasture. Broadleaf weeds are also likely to be a problem in newly germinated pastures unless they are controlled.

Pasture productivity will not necessarily fall drastically after a drought, even though some species will have declined. A 'wait and see policy' for up to two years after the drought will allow sufficient time to gauge the actual effects and allow some species, for example perennial ryegrass, to thicken up from seed produced in the post-drought year.

Opportunity to control weeds

'Weeds' may form a substantial proportion of a post-drought pasture. Any decision to control them should be carefully considered, because they can make a very valuable contribution to the available feed provided they are edible and not harmful to stock.

For any weed control program to be successful, it must include a method for replacing the weeds with more desirable species. Such methods may include chemical control followed by re-sowing and/or grazing management programs. Grazing management combined with chemical control can be successful if the desirable species makes up 20% or more of the pasture composition.

The following spray programs may be considered (but please read the label of the chemical and adhere to withholding periods, safety directions and correct rates):

- spray grazing for broadleaf weeds. Conducted in autumn or early winter after

the break. Spray with a broadleaf herbicide such as MCPA, wait two weeks and graze off the pasture

- winter cleaning for annual grasses (particularly silver grass). Conducted in late winter. Spray with simazine, which prevents the annual grasses from seeding
- spray-topping for annual grasses such as barley grass. Conducted in mid-spring (when plants are in the 'milky dough' stage). Spray with sub-lethal dose of glyphosate and graze off the pasture
- pre-sowing knock down spray. Spray with a lethal dose of glyphosate before sowing a new pasture or fodder crop.

Grazing strategy

When the drought breaks, there will be very little paddock feed remaining and the stock will graze every bit of new green feed as it appears. Heavy grazing at this time can greatly reduce subsequent pasture production. It is recommended that farmers continue to hand feed their stock on a limited area of the farm for up to a month after the break (autumn deferment) to allow the pasture to develop to the point where it can grow strongly and better withstand stock grazing pressure.

Control of insect pests during this time is most desirable. The pests most likely to cause damage are cockchafers and red-legged earth mites.

Need for fertiliser

The amounts and types of nutrients required for pasture growth in the post-drought period should not be different from a normal season. There may be a larger than usual residual effect from fertiliser applied at the start of the drought as a consequence of reduced leaching of nutrients because of the dry conditions. Areas that have been used for intensive feeding may have increased in fertility due to the nutrients supplied by the feed and recycled through the animal. The granules that can sometimes still be seen on the ground during a drought from top dressing are calcium sulphate (gypsum) and they are unlikely to contain any phosphorus. In circumstances of reduced stock numbers and tight finances, it is quite sensible for many farmers to defer or reduce fertilisers for the year.

Nitrogen fertilisers can be used early after the autumn break to boost autumn/winter feed availability. Note that nitrogen fertiliser is best used on improved plant species and may be wasted if pasture composition has been seriously compromised by the drought.

Fodder crops

Fodder crops can be sown on badly eroded annual grass paddocks where pasture seed reserves have blown away. In some circumstances, it is useful to grow a winter fodder crop to boost feed supplies after the drought, but in most cases there is no need to do so, particularly if there is a good early break and stock numbers are down, or if water is available to irrigate the pasture.

Crops of grazing varieties of barley, oats, triticale, annual or Italian ryegrass, Persian or Balansa clover, or mixtures of these, are suitable fodder crops. Areas best suited to fodder crops are those damaged by drought to the extent that the pasture cannot produce sufficient feed to meet stock requirements. Fodder crops will help control weeds prior to re-sowing pasture in the following year, and can provide feed more rapidly than a newly sown pasture.

If feed is needed urgently following the drought, re-sowing permanent pasture can be deferred and a dense fodder crop sown.

Estimated pasture survival

It is an advantage to determine how far a pasture has deteriorated, and what recovery might be expected when rain falls so that early action can be taken.

Examination of paddocks may give an indication of the amount of seed left and the density of living (versus dead) perennial plants. A simple procedure to confirm these observations is to water (with a watering can) a square metre in several places within the paddock and see what grows. In previous droughts the results of this procedure have shown a close relationship to what subsequently germinates.

If stock are in the paddock, it may be necessary to use a fence to protect the watered areas. To stop runoff, build a bank about 10cm high around the area to be watered. Apply the water in March if the autumn break has not occurred, but do not water in the summer months because the normal summer dormancy of seeds and plants, such as phalaris, may not have broken.

Chapter 14

The feed value of unusual feedstuffs

A wide range of unusual feedstuffs can be fed to livestock safely and effectively.

Although such feedstuffs are commonly available in a fairly regular supply, enquiries about their value for feeding to livestock increase when feed for grazing livestock is short, such as during droughts.

Apart from unusual feedstuffs generally being of poor nutritional value, they can also contain chemical residues that can cause contamination of meat and animal products when used as livestock feed.

Potentially all supplementary feeds may contain chemical residues, but unusual feedstuffs, not normally used for feeding livestock, pose a much greater risk as residue transfer assessments are unlikely to have been undertaken. The same applies to imported feedstuffs, which may have high feed value to stock, but where the history of chemical usage is unknown.

Agricultural chemicals used on fruit and vegetable crops are typically designed to be eliminated from the edible parts of the plant at harvesting, however some residues may still be present, and in some cases concentrated, in the waste plant material after processing. It is when this waste plant material is fed to stock that problems can occur.

Agricultural chemicals are not designed to be ingested by livestock. Unless animal residue studies have been conducted, little is known about the effect of these chemicals on stock and about the persistence of residues of these chemicals in animal tissue.

There is a very real possibility that the meat and animal products from stock fed unusual feedstuffs containing chemical contaminants will themselves become contaminated with the chemicals. This can impact severely on trade and market access as well as animal and human health.

For this reason, the best policy is to not feed unusual feedstuffs to stock without first establishing that the material is suitable.

Producers should ask the supplier of unusual feedstuffs to certify that the material they are supplying is suitable for the purpose for which it will be used. **A by-product vendor declaration should also be requested to verify this information.** This will allow the producer to see the full chemical-use history of the potential feed.

Ideally, unusual feedstuffs should be tested for chemical contamination by an accredited testing laboratory before being used as drought feed. However, this in itself may not provide a satisfactory guarantee of suitability, as analytical tests typically only screen for a narrow range of chemicals. Note also that the chemical content of unusual feedstuffs may vary from batch to batch.

The composition of many feedstuffs varies widely because of differences in climate, soil conditions, maturity, variety, management and processing factors. The data presented in this chapter, therefore, should be considered as a guide rather than a precise statement of nutrient composition. Before finalising plans to feed any by-product or unusual feedstuff to livestock, it is advisable to have a sample analysed by a feed analysis service, such as FEEDTEST*. See Chapter 15 for further details.

Most by-products and unusual feedstuffs should be used with caution and introduced into rations gradually, even when low prices favour their use. Factors to consider about unusual feedstuffs are their nutritive value, palatability, possible toxicity or contamination with pesticides or heavy metals and the effects upon digestion and utilisation of the total ration. The use of by-product stockfeed needs to be declared when completing National Vendor Declaration (NVD) forms.

High moisture content feeds

Stock can eat up to 3.5% of their liveweight per day when the feed is in a dry form, such as hay or grain, but they cannot eat as much dry matter if the feed has a high moisture content.

Fresh, high-moisture feeds are often quite palatable to livestock but most such feeds will ferment and sour quickly unless they are dried or ensiled.

Blending and levels of feeding

Many unusual feedstuffs are a reasonable source of energy for the livestock – but quality can vary. It is very important that any new

feedstuff is gradually introduced to livestock over a period of about two weeks.

As a 'rule of thumb', most unusual feedstuffs can be effectively incorporated into the rations of livestock to a maximum of about 30% of the total ration without any significant influence on the health of livestock.

Types of feeds

Stock feed is usually categorised as either concentrates (high in energy) or roughage (higher in fibre, but lower in energy).

Concentrates can be high in either energy or protein content. Protein concentrates generally contain more than 20% crude protein.

By-product energy concentrates

Almond hulls

Almond hull products vary considerably due to varietal differences and harvesting procedures. Soft almond hulls have about 85% of the energy value of barley grain. Some supplies of almond hulls, however, are contaminated with sticks, dirt, hard shells and other foreign materials at harvest time. This greatly reduces their feeding value and acceptability by livestock.

Almond hulls can be used as a partial roughage replacement when roughage supplies are short and forage prices are high.

When mixed with other ingredients in commercial concentrate mixes, almond hulls usually are restricted to 20% or less, in order to maintain high nutrient levels and palatability of the concentrate mix. In complete feedlot rations, almond hulls are limited to about 30% or less.

Apple pomace

Apple pomace is the by-product of apples used for cider or vinegar production. It can be fed fresh, ensiled or dried.

Two problems have hampered feeding of apple pomace in recent years. Pesticide contamination has been a problem in some areas, making the pomace unacceptable in dairy and (occasionally) sheep and beef rations. A second difficulty is that urea or other non-protein nitrogen compounds should not be fed with apple pomace because of the possibility of abortions and/or abnormalities of offspring. The reason for this is unknown.

Apple pomace is a highly palatable feed, medium in energy but very low in protein. When properly supplemented, it can replace

up to about one-third of the concentrates in rations and 15-20% in complete feedlot rations.

Bakery waste

Large amounts of unsold bread, doughnuts, cakes and other pastries are available in some areas and are excellent energy sources for ruminant rations. Bakery waste however, may potentially contain meat or other animal protein and should therefore be used with caution and in accordance with ruminant feed ban legislation.

Bakery waste is usually high in fat and low in crude fibre. Protein levels (on a dry-matter basis) in the range of 10-12% are typical. The low fibre content of the baked material and the baking process itself result in a feed which tends to stimulate ruminal propionate and reduce ruminal acetate production. This is desirable for feedlot livestock being fattened for market.

Up to about 10% can be included in feedlot rations when supplies and economics are favourable. Supplies should be fed quickly.

Brewer's grains

Brewer's grains have 20-25% crude protein (on a dry matter basis), making them a good protein source in addition to their energy value.

The brewing process makes this protein less soluble than that from many protein supplements. This could be valuable in rations, such as silage supplement with non-protein nitrogen, which contain large amounts of soluble protein.

Brewer's grains are fed both wet and dried. In the dry form they have about 80% of the energy value of barley grain (the energy value varies depending on the brewery and additives used in the brewing process). They are not as palatable in the dried form as the original grain and are usually included as 25% or less of a dairy concentrate mix, and 1-20% in feedlot rations.

Citrus pulp

Citrus pulp is classified as a concentrate but is also valuable as a partial roughage replacement because of its high level of digestible fibre.

It commonly contains about 15% crude fibre in the dry matter. Its energy value is about 94% of the value of barley grain. It has only about 7% crude protein in the dry matter.

Citrus pulp is usually fed dehydrated. It must be introduced gradually into a ration to let stock get accustomed to its distinctive smell and taste. Levels of up to 15-20% are acceptable in feedlot rations.

Citrus pulp can also be fed fresh or as silage. Both are very acceptable to stock but pulp and peels from lemons are somewhat more acceptable than those from oranges and grapefruit. Transportation costs preclude the wet pulp from being fed very far from processing plants.

Citrus pulp is high in calcium and low in phosphorus, and can aggravate the high calcium-to-phosphorus ratio in a ration when fed with legumes such as lucerne. Unless counter-balanced by other feeds low in calcium and high in phosphorus, citrus pulp can result in higher incidences of milk fever in cattle at, or soon after, parturition.

Fat

Fats and oils have energy values of about 2.25 times that of carbohydrates. Fats are also used to settle the dust and as a lubricant for feed processing. From 2-5% fat is an acceptable level in commercial feedlot rations. Care must be taken, however, to ensure the fats and oils are not contaminated with extraneous chemicals during collection, storage and use. Tallow and used cooking oil may only be used in accordance with Ruminant Feed Ban Regulations.

Grain screenings

Grain screenings result from the cleaning of small grains before they are milled for human consumption. The best grade of screenings consists primarily of broken and shrunken kernels of grain, wild oats and other palatable weed seeds. When ground, good screenings approach grain in feeding value and have been used as 25% or more of concentrate mixed and 15-20% in feed rations. Light, chaffy screenings, however, are much higher in fibre and resemble straw more than grain in feeding value. Such screenings should be restricted to 10%.

Grape pomace or marc

Grape pomace or marc is the refuse in the production of grape juice and wine. It consists mainly of some combination of grape seeds, stems and skins. It has little feeding value, being very variable in both energy and protein and highly variable in dry matter. When included in a concentrate mix, it can be considered only as a filler to reduce the price of the mix. With new harvesting and winery techniques, grape pomace containing few or

no stems can be produced. This waste feed has been fed successfully at up to 15-20% of complete feedlot rations.

Grape marc has been found to be extremely palatable to sheep and lambs in pen trials where they consumed 350g/head/day when fed with straw. This diet was effective in reducing weight loss only.

Studies have found partitioning of oil-soluble chemicals in grape seeds at violative levels, which would readily transfer to animal fat upon ingestion. There are also concerns about residual levels of copper, which can be toxic to stock, used in fungicides on grapes.

Onions

Onions have been fed successfully to cattle and sheep and they eat them readily. They can, however, cause anaemia in sheep so introducing onions over a period of time is recommended and only up to 50% of the total ration.

Rice bran

Rice bran results from the processing of rice grain for human consumption. Besides the bran itself, it contains the germ from the grain and fragments of the hull not removed in milling. Levels of up to 15% have been fed successfully to livestock. At these levels, it is roughly equivalent to wheat bran in nutritional value.

Wheat bran and other wheat by-products

Wheat bran consists of the coarse outer coatings of wheat kernels. It is a bulky feed which is relatively high in protein and phosphorus. It is highly palatable to livestock and is utilised efficiently when up to 25% is included in the concentrate mix. From 10-20% of wheat bran and other wheat by-products can be used in feedlot diets. The bulky nature of wheat bran and its high phosphorus content make it a popular by-product feed for livestock.

Whey

Whey is the residue from cheese production and consists primarily of lactose, minerals and water. It can be fed dry or liquid. Pollution control regulations and the high cost of drying have resulted in increasing amounts being used as feed liquid in recent years.

Dried whey is a major component of many dry milk replacers fed to calves. It is usually too expensive to be included in rations for older animals but it is sometimes included at low levels in pelleted feeds because of its binding characteristics as well as its nutrients.

Liquid whey contains only 6-7% solids and must be fed quickly or it will spoil. In cool climates it can be stored for 3-4 days before feeding. In warm climates it should be fed the same day that it is delivered.

Liquid whey is frequently available for only the hauling costs, making it an inexpensive source of nutrients for animals located near cheese plants. Supplies are often variable, however, and storage of whey attracts fly problems.

Tomato pomace

The feeding value of tomato pomace on a dry basis is comparable to good-quality hay. Variability (especially moisture content) is one of the main problems associated with the use of this by-product feed. In one study, dry matter varied from a high of 27.5% to a low of 11.9%. Pesticide contamination can also be a problem with tomato pomace.

By-product protein concentrates

Many crops grown for oil production also produce by-products high in protein. These by-products are the primary source of supplemental protein in livestock rations. These include coconut meal, corn gluten meal, cottonseed meal, linseed meal, safflower meal, soybean meal and sunflower meal. Some of these have high fat levels and should therefore not be fed as the whole diet.

Additionally, such by-products as distiller's grains are used extensively as protein supplements in livestock rations. Brewer's grains, previously discussed as an energy feed, are also relatively high in protein content.

Coconut meal/copra

Coconut meal, popularly known as copra, is one of the most palatable feeds available for livestock. It is high in energy and contains about 20% protein. Rancidity can be a problem during storage if the meal is high in fat but high-fat copra contains considerably more energy than copra produced by the solvent process.

Cottonseed meal

Cottonseed meal is a by-product of the production of cotton lint and cottonseed oil. It contains about 40% protein and is well liked by livestock. The amount of oil left in the meal will affect its energy value (amounts vary according to the method of processing). Energy levels, however, are somewhat lower than those found in some other protein supplements such as coconut meal, soybean meal and linseed meal.

Linseed meal

Linseed meal, the by-product of the extraction of linseed oil from flaxseed, is an excellent protein supplement for livestock. Protein content varies from about 30-38% depending on the source of processing method. When reasonably priced, it can be used as the only protein supplement in livestock rations because it is very palatable.

Poultry litter and manure

Poultry waste (litter and/or manure) has been included in the diets of sheep and cattle in previous droughts but **is now prohibited under the Ruminant Feed Ban**.

Safflower meal

Safflower meal has increased in availability and importance as a protein supplement in recent years because of the popularity of safflower oil in human diets. Safflower meal from unhulled seeds, has about 20% protein, is high in fibre and is relatively low in energy. Meal made from well-hulled seeds has about 40% protein and is much higher in energy.

Safflower meal from either source, however, is not as palatable to livestock as the more common protein supplements and is usually restricted to 20% or less of concentrate mix.

Soybean meal

Soybean meal contains from 40-50% protein, is high in energy and is highly palatable to livestock.

Sunflower meal

Protein levels vary from 20-25%, depending on the processing method and whether the seed is hulled or not. It is roughly equivalent to cottonseed meal as a protein supplement for livestock.

By-product roughage

Canola hay and silage

Canola hay and silage are likely to be available as a fodder source in droughts where frost damage has occurred. Both hay and silage can be of good quality but this can vary and there are some livestock considerations. Table 20 is a summary of sample results conducted by FEEDTEST* in Victoria on canola hay and silage samples submitted during 2006-2007.

Canola hay that has not been aggressively conditioned may have sharp stalk ends and these can pose a problem to animals by piercing the rumen. There have been reported instances of nitrate poisoning from canola products. It is recommended that canola hay or silage is introduced slowly, and that it is not fed as a sole ration or to starving animals.

Table 20. Mean and range of canola hay and silage samples from the 2006-2007 season
(Source FEEDTEST* 1 Aug 06 – 10 Jan 07)

Description	Crude protein CP (%)	Dry matter digestibility DMD (%)	Metabolisable energy ME (MJ/kg DM)	Neutral detergent fibre NDF (%)
Hay, canola (508 samples)	16.2 4.0-27.2	67.1 33.0-85.3	9.9 4.1-13.1	40.6 25.4-66.9
Silage, canola (141 samples)	17.6 9.7-26.3	66.3 45.6-81.7	10.1 7.3-12.4	41.5 25.6-57.4

Rice hay

Rice hay is generally a good, palatable roughage of equivalent feed value to cereal hays. Rice hay, however, is known to contain significant levels of silica and oxalate, both of which may cause problems to livestock. High dietary silica levels can predispose animals to urinary calculi.

If rice hay is fed as the roughage in a hay and grain diet, it is suggested that 1.5% limestone and 0.5% salt is fed to correct the calcium: phosphorus balance in the ration. Rice hay can contain a range of weeds such as umbrella sedge, barnyard grass, starfruit and wild millet.

Rice hulls

Rice hulls have practically no feed value but can be useful as bedding material for livestock.

They are very high in crude fibre and silica and the fibre is largely indigestible. Up to 15% of unground rice hulls, however, can be included as a roughage source in drought rations being fed to livestock.

Sawdust

Sawdust has virtually no feed value for sheep or cattle because of its high level of lignification. It has been shown to be useful, however, when feeding high concentrate diets to sheep or cattle during droughts. Sheep survival rates in drought have been shown to be better when 15-20% sawdust (hoop pine and spotted gum) was included in the wheat rations.

Sawdust has also been successfully used as a diluent for adapting cattle to a concentrated diet. The inclusion of 5-15% sawdust in maize-based diets for cattle was found to maintain better rumen function as evidenced by fewer cases of bloat and liver lesions and less ruminal perakeratosis.

Coarse sawdust was better than fine sawdust in maintaining rumen function.

Sawdust from treated timber should not be used.

Seaweed

Kelp represents the most common type of seaweed that might be available for feeding. The dry matter of kelp contains about 30% minerals (compared to 5-6% in hay, pasture, etc). Kelp contains 0.15-0.2% iodine. Seaweed is sometimes used as a mineral source for livestock.

Kelp can be fed quite satisfactorily at up to about 25% of the diet of livestock. The composition of dried kelp is dry matter 91%, crude protein 6%, minerals (ash content) 30%. ME value of kelp is about 5MJ per kg DM.

The rich mineral content of seaweed, especially salt, can make the material quite palatable to livestock.

Waste paper

Waste paper has little or no feed value for sheep or cattle unless it is treated in some way to improve its digestibility and palatability. It has been fed as a roughage source, on some occasions.

However, because of its poor feed value and the risk of the paper containing contaminants such as lead, cadmium, polychlorinated biphenyls and other toxic substances, the feeding of waste paper to sheep or cattle is not recommended.

Table 21. Energy and protein compositions of unusual feedstuffs

(If known, ranges in feed values are given in brackets. It is likely that most of these feedstuffs will vary and values are a guide only.)

Feed	Approx. dry matter (DM) %	Metabolisable energy (ME) (MJ/kg DM)	Crude protein % dry matter
Acorns	70	7	5
Almond hulls, 15% CF	90	8	2
Almond hulls and shells, 20% CF	90	7	2
Apple pomace, dried	89	10	5
Apple pulp silage	21	11	8
Apples	17	10	3
Apricots, dried	90	12	6
Bakery waste, dried	92	13	11
Banana skins, dried, ground	88	9	8
Bananas	24	13	4
Bread, dried	92	13	13
Brewers dried grains	92	9	22
Brewers dried grains, 25% protein	92	10	25
Brewers grains, wet (range)	28 (14-61)	11 (8-14)	22 (10-29)
Broccoli	11	10	33
Brussel sprouts	15	11	33
Buckwheat	87	11	12
Cabbage	9	13	25
Cabbage leaves	15	10	14
Canola meal (range)	91	12 (10-16)	38 (27-42)
Carrot pulp (range)	10 (8-16)	13 (9-14)	10 (6-15)
Carrots	13	12	10
Cauliflower	9	10	30
Citrus pulp (range)	14 (11-17)	13 (10-15)	9 (6-12)
Copra (coconut) meal	90	11	21
Corn cobs, ground	90	7	3
Cottonseed meal, 41% protein mech-extd	93	3	44
Cottonseed meal, 41% protein, solv-extd	91	11	46
Cottonseed, whole	92	14	23
Grape marc or pomace (range)	55 (20-94)	6 (2-12)	12 (5-17)
Grape/pear/apple pomace, dried	92	6	7
Grapefruit	14	13	8
Kelp, dried	91	5	7
Lemon pulp, dried	93	12	7
Lettuce	5	8	22
Linseed meal, 36% protein, solv-extd	90	12	38
Linseed meal, 37% protein, mech-extd	91	12	38
Melons	4	11	11
Milk, cattle, skim, dried	94	13	36
Milk, cattle, whole, dried	94	15	27
Milk, colostrum	25	15	46
Molasses, cane	75	11	6

Table 21. Energy and protein compositions of unusual feedstuffs continued

Feed	Approx. dry matter (DM) %	Metabolisable energy (ME) (MJ/kg DM)	Crude protein % dry matter
Oat hulls	93	5	4
Oat straw	92	7	4
Oats, sprouted 5 days	13	10	18
Onions	11	13	10
Orange pulp, dried	88	12	8
Orange pulp, wet	25	12	9
Oranges	13	12	7
Palm kernal meal	88	11	17
Pea hay	88	9	14
Peaches	10	12	9
Peanut meal, mech-extd	93	12	52
Peanut meal, solv-extd	92	12	52
Peanut skins	94	10	17
Pears	17	13	6
Pineapples	15	12	3
Potato meal, dried	91	12	11
Potatoes	23	12	9
Pumpkins	9	13	16
Raisin pulp, dried	89	8	11
Raisins, cull	85	7	4
Rice bran	90	14 (9-15)	16 (13-20)
Soyabean meal	85 (12-94)	15 (13-16)	44 (30-54)
Sunflower meal	91	10 (8-14)	34 (20-39)
Whey	8 (2-27)	14 (12-14)	30 (20-40)

It is important to assess the risk of these feedstuffs and take appropriate precautions to ensure that the quality and integrity of the meat or other end product is not jeopardised.

Chapter 15

Additional information

FEEDTEST® – feed quality assessment for beef cattle

Beef producers now recognise that guesswork is no longer good enough when it comes to judging the quality of hay, grain, silage and other feedstuffs. Objective assessment, based on factors that affect animal performance, is being increasingly used to describe feed quality, which can vary widely. This variation is often very difficult, if not impossible, to detect visually.

The ME of pasture hay can vary from 6.5 megajoules per kilogram (MJ/kg) of dry matter for very poor, mature grass hay to 9.5 MJ/kg for top quality clover-dominant hay. Protein can range from 6-19% in hay. Silage can show similar variation, and in the case of cereal grains, protein can vary from 5-16% and ME from 9-13 MJ/kg.

The only reliable way to know the value or otherwise of the feed you are using or looking at buying, is to have a sample tested.

Sampling and sample submission

Always remember that the analysis is only as good as the sample, which must adequately represent the feed being tested. Hay and silage in particular, are quite variable, so great care is needed when sampling them.

Sampling hay

Use a coring device, made from 32mm steel tubing about 450mm long, and attached to an electric drill or hand brace. The cutting edge should be slightly scalloped and must be kept sharp. Each sample should consist of cores taken at random from 15-20 bales, with each core taken from the 'butt' end of a bale.

Take separate samples to represent different paddocks, cutting times, clover content, weather damage etc.

Hay and silage can be sampled by hand as described in the silage section. This method, however, is much less accurate.

Sampling silage

Sample by hand from 10-20 spots across a freshly cut face of the stack, mix thoroughly and sub-sample, to yield a total amount not exceeding 500g. Alternatively, use a hay corer if feasible. Seal the sample in a strong airtight

plastic bag (NOT a freezer bag) before placing in a FEEDTEST® sample envelope. Send the sample immediately. If a delay is unavoidable, refrigerate or freeze the sample until it is sent, especially in hot weather.

Sampling pasture

Walk through the paddock at random, and cut a sample, to ground level with hand shears, from near the toe of your right boot, every ten steps. Ensure that the same sized area is cut every time (about 30 square centimetres), and that you sample from at least 15 locations in the paddock. Combine these samples into one and thoroughly mix to obtain an amount not exceeding 500g. Treat the sample exactly as for silage. Be careful not to contaminate the sample with soil or faeces.

Sampling grains and pellets

Select several sub-samples from different 'locations' or bags, which make up the complete lot. Thoroughly mix the sub-samples and send 300-400g of this mix for testing.

Submitting samples to FEEDTEST® is easy with sample envelopes available at all Department of Primary Industries offices. One envelope should be used for each sample, and flimsy freezer bags should NOT be used – they burst in transit! The enclosed sample information sheet must also be filled out, giving details of the feed and its intended use. Samples should be posted as soon as possible after collection, and perishable samples, for example silage, should be sent early in the week so that processing is not delayed by a weekend.

The FEEDTEST® report

Each FEEDTEST® report will include the following tests:

- moisture – the amount of water in the feed, varying from about 10% for grains to over 80% for fresh pasture
- dry matter (DM) – refers to the amount of feed remaining after the water has been removed. Because the water content of feeds can vary considerably, all analyses are expressed on a dry matter basis
- crude protein (CP) – the amount of true protein (composed of amino acids) and non-protein nitrogen in the feed. While it is desirable to have a high CP, it can be misleading to use it as the sole measure of feed quality
- digestible dry matter (DDM) – the percentage of the feed dry matter actually digested by animals. It is estimated using a

laboratory method, which is standardised against DDM values from feeding trials. High quality feeds have a DDM of over 65%, while feeds below 55% DDM, are of poor quality and will not maintain liveweight even if stock have free access to them

- metabolisable energy (ME) – is the feed energy actually used by the animal, calculated from DDM and expressed as megajoules per kilogram of dry matter (MJ/kgDM). ME is the most important figure on the report. It is used to calculate whether stock are receiving adequate energy for maintenance or production.

It should be noted that all FEEDTEST* analyses are expressed on a dry matter basis. However, in the paddock you will need to calculate the amount of feed supplement to use on an 'as fed' basis. For example, if a sample of oats has an ME of 11 MJ/kg DM, a CP content of 9% (on a DM basis) and a DM content of 90%, the 'as fed' values will be:

$$\text{ME} = 11 \times 90\% = 10 \text{ MJ/kg DM} \quad \text{CP} = 9 \times 90\% = 8\% \text{ CP}$$

Further information

Further information on the FEEDTEST* service can be obtained from:

FEEDTEST*,
Reply Paid 60563
Private Bag 105
Hamilton VIC 3300

Ph: 03 55 730 910
Fax: 03 55 730 939
Free Call: 1800 655 474

Email: feedtest@dpi.vic.gov.au

FEEDTEST*
Reply Paid 78842
26-28 Wellington Street
Kerang VIC 3579

Ph: 03 54 504 286
Fax: 03 54 502 478

Appendix 1

Weight of hay and silage bales

	Bale type	Wet weight (kg)	Dry matter (%)	Dry weight (kg)
Hay	Small square	23	85	20
	4 x 4 round	250	85	215
	5 x 4 round (15 small bale equivalents)	350	85	300
	5 x 6 round (20 small bale equivalents)	500	85	425
	8 x 3 x 3 square	300	85	255
	8 x 4 x 3 square	600	85	510
	8 x 4 x 4 square	750	85	640
Silage	4 x 4 round	700	35	245
	1 cubic metre (wilted)	580	30	175
	1 cubic metre (direct cut)	830	18	115
	1 cubic metre maize silage	500	35	175

List of tables

Table 1. Quantities for full hand feeding (kg/hd/day) of common classes of stock	7
Table 2. Assumptions used in Tables 1, 3 and 4	7
Table 3. Metabolisable energy (MJ/hd/day) supplied by pasture of different quality and availability	11
Table 4. Feed required to supply different levels of energy	11
Table 5. Minimum and desired fat scores for different classes of stock	15
Table 6. Energy and protein compositions of common livestock feeds	18
Table 7. Energy and protein compositions of common grains	19
Table 8. Cents per megajoule of energy calculated from \$/tonne and MJ/kg DM	20
Table 9. Steers and heifers (after weaning)	24
Table 10. Cows dry, pregnant mature	24
Table 11. Cows with suckling calves up to four months old	25
Table 12. Bulls	25
Table 13. Quantities for full hand feeding (kg/hd/day) for common classes of stock	26
Table 14. Animal water requirements Litres per animal per day	30
Table 15. Salt tolerance in drinking water for various classes of cattle	32
Table 16. Digestibility of whole vs processed grain	34
Table 17. Energy and protein requirements of calves of various liveweights	45
Table 18. Some diets for early weaned calves	45
Table 19. Examples of feedlot rations	50
Table 20. Mean and range of canola hay and silage samples from the 2006-2007 season	59
Table 21. Energy and protein compositions of unusual feedstuffs	60

Index

A		I	
Action plan	5	Internal parasites	37
Agist stock	5	Introducing cattle to grain	33, 34
Algal blooms	31	M	
Animal health	35, 36, 37, 41	Maintenance	6, 12, 15, 26, 28, 39, 51, 63
Annual species	39, 52	Maximising winter production	9
C		Maximum intake	23
Calcium	28, 34, 35, 41, 44, 45, 49, 53, 57, 59	Metabolisable energy	4, 11, 16, 18, 19, 20, 22, 23, 24, 25, 28, 34, 45, 59, 60, 61, 63
Chemical residues	22, 36, 55	Minerals	16, 28, 40, 48, 49, 50, 57, 59
Controlled weight loss	15	Molasses	23, 29, 44, 60
Cost of feed	19, 21, 41, 48	N	
Creep feeding	46, 47	NDF	17, 34, 41, 59
Crude protein	4, 7, 16, 18, 19, 22, 23, 24, 25, 27, 45, 49, 56, 59, 60, 61, 62	Nitrate poisoning	9, 51, 52, 58
D		Nitrogen fertiliser	9, 53
Digestibility	10, 11, 27, 34, 47, 49, 59	Noxious weeds	21
Dry matter	4, 7, 9, 10, 17, 18, 19, 20, 23, 24, 25, 26, 27, 45, 49, 55, 56, 57, 58, 59, 60, 61, 62, 63, 64	O	
E		Opportunity lotfeeding	48
Early weaning	15, 43, 44	P	
Electrical conductivity	4, 32	Pasture availability	9, 10, 12
Energy and protein requirements	23, 24, 26, 44, 45	Pasture recovery after a drought	41, 52
F		Perennial species	52
Fat score	6, 13, 14, 15, 36, 41, 43	Pregnancy toxæmia	36
Feed budget	6, 26	Processing of grain	34
Feed costs	6	S	
Feed stock	5, 6	Salt content	31
Feeding for survival	13, 15	Salt tolerance	32
Feeding pellets	35	Sell stock	5
FEEDTEST®	16, 22, 26, 28, 34, 55, 58, 59, 62, 63	Sodium bentonite	28, 34, 35, 41
Fibre	16, 17, 21, 22, 28, 29, 34, 41, 44, 56, 57, 58, 59	Stock containment areas	39, 40, 41
Fodder crops	54	Straw and urea	28
G		Surface area of the dam	30
Grain processing	21	U	
Grain sickness	33, 34	Unusual feedstuffs	22, 55, 56, 60
H		V	
How much to feed	6, 8, 12, 17	Vendor declarations	6
		Vitamins	16, 28, 49, 50
		W	
		Water during a drought	30
		Water requirements	30, 31, 38, 43