**CALIFORNIA SALMONID STREAM
HABITAT RESTORATION MANUAL**

FOURTH EDITION

Prepared by:

**GARY FLOSI, SCOTT DOWNIE, JAMES HOPELAIN,
MICHAEL BIRD, ROBERT COEY, and BARRY COLLINS**

**State of California
The Resources Agency
California Department of Fish and Game
Wildlife and Fisheries Division**

CALIFORNIA SALMONID STREAM HABITAT RESTORATION MANUAL

DEDICATION

to

Tim Curtis

1944 - 1996

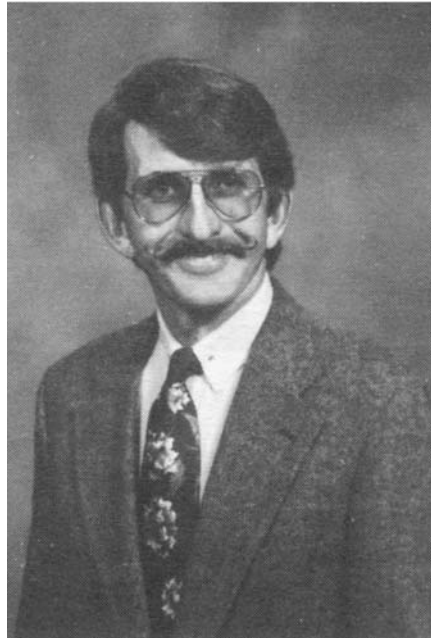

The authors of the third edition of the *California Salmonid Stream Habitat Restoration Manual* wish to dedicate their work to **Tim Curtis**. Tim served with distinction with the California Department of Fish and Game as a fishery biologist, program supervisor, and patient mentor from 1971 to 1996. He was a pioneer in the Department's modern salmonid habitat restoration program and a contributing author to the second edition of this manual. Tim died much too young at age fifty-one, October 19, 1996, after a courageous battle with brain cancer.

Tim was a friend and motivational guide to all he came near. Although his life was brief he left his creative, inspirational mark on many. The third edition of this manual is part of his living legacy passed on through the present authors, and as such will continue to help improve the health of a resource he loved: the salmon and steelhead of California.

CALIFORNIA SALMONID STREAM HABITAT RESTORATION MANUAL

PREFACE

The first edition of this manual, written by Gary Flosi and Forrest Reynolds, and published in 1991, formally synthesized and described the Department of Fish and Game's approach and technical methods for anadromous salmonid habitat restoration. From 1991 through 1994 the first edition was broadly distributed and used as a "standard methods" text by many habitat restoration and resource inventory workers. As a result, many suggestions for improvement of the manual were received by the authors.

The second edition, by Flosi and Reynolds was supported by a team that included the authors of this third edition, and was published in October of 1994. The second edition included a number of revisions: 1) a reorganization of sections for project planning and project implementation; 2) the just then recently revised stream channel classification system developed by David Rosgen; 3) a new monitoring and evaluation section; 4) a listing of all databases used for resource inventory and analysis as presented in the manual; 5) a protocol for a large woody debris inventory; 6) a description of required environmental review processes and permits; 7) an expanded and updated listing of sensitive species; and 8) numerous editorial changes to text and data forms.

The third edition, like the second, incorporates changes recently developed in the practice of stream habitat inventory and restoration. The authorship list has changed with this edition to more accurately reflect the contributions of the writing team members. The manual is presented in binder form in this edition to more easily and economically incorporate future additions and developments as they evolve.

This fourth edition incorporates all changes, corrections, and revisions of this manual up to July 2010. The manual continues in binder form in this edition to easily and economically incorporate future additions and developments as they evolve.

The authors anticipate the continued widespread distribution and use of this manual will promote the implementation of the restoration techniques discussed. Additionally, in an effort to develop common methods for data collection and data storage of information, the authors encourage all anadromous salmonid resource assessment professionals to utilize protocols and database structures presented in this manual.

Readers should also be aware that computer data entry and data summary programs are available upon request for all data collection protocols presented in this manual. Updates to this manual are available on line at <http://www.dfg.ca.gov/fish/Resources/HabitatManual.asp>.

**CALIFORNIA SALMONID STREAM
HABITAT RESTORATION MANUAL**

TABLE OF CONTENTS

VOLUME I

PREFACE	ii
ACKNOWLEDGEMENTS	xvii
FOREWORD	xviii
PART I. SALMON AND STEELHEAD HABITAT RESTORATION IN CALIFORNIA	
DEVELOPMENT OF CALIFORNIA'S FISH HABITAT RESTORATION PROGRAM..... I-1	
ORGANIZATION AND FUNDING OF CALIFORNIA'S FISH HABITAT RESTORATION PROGRAM.....	I-3
FISHERY RESTORATION PLANNING OBJECTIVES.....	I-4
PART II. PRELIMINARY WATERSHED ASSESSMENT	
PRELIMINARY WATERSHED ASSESSMENT	II-1
WATERSHED OVERVIEW.....	II-1
Tools and Supplies.....	II-2
Instruction for Completing the Watershed Overview Work Sheet.....	II-2
WATERSHED OVERVIEW WORK SHEET.....	II-7
MAPS AND THEIR USE.....	II-8
AERIAL PHOTO INTERPRETATION: HISTORICAL SEQUENCE.....	II-9
HISTORICAL STREAM SURVEY REVIEW.....	II-10
WATER.....	II-10
RIPARIAN ZONE.....	II-11
SEDIMENT SOURCES.....	II-12
Mass Wasting.....	II-13
Surface Erosion.....	II-13
Stream and Channel Erosion.....	II-14
HYDROGRAPHS.....	II-14
REFERENCES.....	II-17
PART III. HABITAT INVENTORY METHODS	
HABITAT INVENTORY METHODS.....	III-1
HABITAT INVENTORY FIELD PREPARATION.....	III-1
Tools and Supplies Needed for Two Person Crew.....	III-2
STREAM CLASSIFICATION SYSTEM.....	III-2
Stream Channel Type Definitions.....	III-3
Stream Type Delineation Criteria.....	III-3
STREAM CHANNEL TYPE DESCRIPTIONS AND STRUCTURE SUITABILITY.....	III-8
Stream Channel Types.....	III-8

CALIFORNIA SALMONID STREAM HABITAT RESTORATION MANUAL

STREAM CHANNEL TYPE WORK SHEET.....	III-22
Instructions for Completing the Stream Channel Type Work Sheet.....	III-23
STREAM CHANNEL TYPE WORK SHEET (Form).....	III-26
HABITAT TYPING.....	III-27
Definition of Habitat Types.....	III-29
Level I Habitat Types:	III-29
Level II Habitat Types:	III-29
Level III and Level IV Habitat Types:	III-29
Level IV Habitat Type Descriptions:	III-30
Instream Shelter.....	III-43
Instream Shelter Complexity.	III-43
Instructions for Completing the Habitat Inventory Data Form.....	III-44
HABITAT INVENTORY DATA FORM.....	III-48a
LARGE WOODY DEBRIS (LWD)	III-49
STREAM AND RIPARIAN INVENTORY.....	III-49
Background.....	III-49
LWD INVENTORY METHODOLOGY.....	III-50
Equipment list:	III-50
Stream selection.....	III-50
Training.....	III-51
Inventory Procedure.....	III-51
LWD INVENTORY FORM KEY.....	III-53
LWD INVENTORY FORM.....	III-55
ESTIMATE CALIBRATION FORM.....	III-56
REFERENCES.....	III-57

PART IV. FISH SAMPLING METHODS

FISH SAMPLING METHODS.....	IV-1
STREAM BANK OBSERVATION.....	IV-2
UNDERWATER OBSERVATION.....	IV-3
Tools and Supplies Needed.....	IV-3
Instructions for Completing the Stream Bank or Underwater Observation Field Form.....	IV-4
STREAM BANK OR UNDERWATER OBSERVATION FIELD FORM.....	IV-6
SALMON SPAWNER SURVEYS.....	IV-7
Tools and Supplies Needed.....	IV-7
Instructions for Completing the Daily Salmon Spawning Stock Survey Field Form.....	IV-8
DAILY SALMON SPAWNING STOCK SURVEY FIELD FORM.....	IV-11
ELECTROFISHING.....	IV-12
Instructions for Completing the Electrofishing Field Form.....	IV-12
ELECTROFISHING FIELD FORM.....	IV-16
ELECTROFISHING FIELD FORM SUPPLEMENTAL PAGE.....	IV-17
REFERENCES.....	IV-18

CALIFORNIA SALMONID STREAM HABITAT RESTORATION MANUAL

PART V. WORKING WITH THE DATA

WORKING WITH THE DATA.....	V-1
DATA ENTRY.....	V-1
DATA SUMMARY AND ANALYSIS.....	V-2
Data Summary.....	V-2
Data Analysis.....	V-15
GIS FORMAT.....	V-15
Software.....	V-16
Data.....	V-16
Analytical Tools.....	V-16
STREAM REPORTS.....	V-16
DATA MANAGEMENT.....	V-17
Data Storage.....	V-17
Data Distribution.....	V-17
RECOMMENDATIONS.....	V-17
Interpreting Physical Habitat and Biological Inventories and Relating this Information to Critical Habitat Needs.....	V-17
Salmonid Habitat Requirements and Suggestions for Instream Structures to Enhance Critical Habitat.....	V-20
Chinook Salmon.....	V-20
Coho Salmon.....	V-21
Steelhead.....	V-22
Coast Cutthroat Trout.....	V-23
Resident Trout.....	V-23

PART VI. PROJECT PLANNING AND ORGANIZATION

PROJECT PLANNING AND ORGANIZATION.....	VI-1
Permits That May Be Required.....	VI-2
FISH HABITAT RESTORATION CATEGORIES.....	VI-3
Upslope Watershed Treatments.....	VI-3
Riparian Zone Treatments.....	VI-3
Instream Habitat Improvements.....	VI-4
Artificial Propagation.....	VI-4
Watershed Stewardship Training.....	VI-5
INSTREAM STRUCTURE SUITABILITY BY STREAM TYPE.....	VI-5
PROJECT RECOMMENDATION DEVELOPMENT FROM HABITAT INVENTORY DATA.....	VI-6
PROJECT SITE LAYOUT.....	VI-11
Using Basic Hydraulic Analysis For In Channel Design.....	VI-11
Surveying the Longitudinal and Cross Sectional Profiles.....	VI-12
Analysis of Longitudinal Profile.....	VI-14
Analysis of Cross Sectional Profiles.....	VI-15
REFERENCES.....	VI-17

CALIFORNIA SALMONID STREAM HABITAT RESTORATION MANUAL

PART VII. PROJECT IMPLEMENTATION

PROJECT IMPLEMENTATION.....	VII-1
SELECTION OF STABLE SITES.....	VII-1
Gradient.....	VII-1
Stream Width.....	VII-2
Substrate.....	VII-2
Stream Order.....	VII-2
Reach Length.....	VII-2
Channel Sinuosity.....	VII-2
Bank Stability.....	VII-3
Bank Morphology.....	VII-3
HYDRAULIC IMPACTS.....	VII-3
SELECTION OF MATERIALS.....	VII-6
Basic Structural Materials.....	VII-7
Gabions.....	VII-7
Logs.....	VII-7
Root Wads.....	VII-7
Boulders.....	VII-8
Miscellaneous Structural Materials.....	VII-9
Geotextile Fabric.....	VII-9
Wire Fencing.....	VII-9
Concrete.....	VII-10
Wire Rope.....	VII-10
ANCHORING TECHNIQUES.....	VII-10
Cabling to Boulders or Bedrock Using Polyester Resin Adhesive.....	VII-10
Cabling to Logs and Root Wads.....	VII-11
Cabling Logs and/or Root Wads to Boulders or Bedrock.....	VII-12
Log Pinning With Rebar.....	VII-16
Stream Bank Anchors Using Rebar.....	VII-17
Bedrock and Boulder Anchors Using Threaded Rebar.....	VII-18
Threaded Rebar and Cable Anchor to Boulder or Bedrock.....	VII-19
Expansion Bolts.....	VII-20
Trenching.....	VII-21
Deadman.....	VII-22
Unanchored Large Woody Debris.....	VII-23
INSTREAM HABITAT IMPROVEMENTS.....	VII-24
Cover Structures.....	VII-24
Divide Logs.....	VII-25
Digger logs.....	VII-26
Spider Logs.....	VII-27
Log, Root Wad, and Boulder Combinations.....	VII-28
Bolder Structures.....	VII-29
Boulder, weirs.....	VII-29
Vortex Bolder Weir.....	VII-32
Boulder Clusters.....	VII-34
Single and Opposing Boulder Wing-Deflectors.....	VII-35

CALIFORNIA SALMONID STREAM HABITAT RESTORATION MANUAL

Log Structures.....	VII-36
Log Weirs.....	VII-36
Upsurge Weirs.....	VII-42
Single and Opposing Log Wing-Deflectors.....	VII-43
Hewitt Ramps.....	VII-44
Placement of Imported Spawning Gravel.....	VII-46
Fish Screens.....	VII-46
FISH PASSAGE.....	VII-47
Obstructions.....	VII-48
Log Jams.....	VII-49
Beaver Dams.....	VII-49
Waterfalls and Chutes.....	VII-50
Landslides.....	VII-50
Human-Induced Obstructions.....	VII-51
Fishways.....	VII-51
Step-and-Pool Fishway.....	VII-52
Denil Fishway.....	VII-54
Alaskan Steep-pass.....	VII-55
Culverts.....	VII-56
Back-Flooding Weirs.....	VII-56
Culvert Baffles.....	VII-57
Washington Baffles.....	VII-57
Corrugated Metal Pipe (CMP) Steel Ramp Baffles.....	VII-60
WATERSHED AND STREAM BANK STABILITY.....	VII-62
Slide Stabilization.....	VII-62
Stream Bank Stabilization.....	VII-63
Boulder Stream Bank Stabilization Structures.....	VII-63
Boulder Riprap.....	VII-63
Boulder Wing-Deflectors.....	VII-66
Log Stream Bank Stabilization Structures.....	VII-67
Cribbing.....	VII-67
Live Vegetated Crib Wall.....	VII-68
Bank Armor.....	VII-69
Log Wing-Deflectors.....	VII-71
Tree Revetment.....	VII-73
Native Material Revetment.....	VII-74
Mulching.....	VII-75
Revegetation.....	VII-76
Transplanting.....	VII-76
Revegetation with Willow Sprigs.....	VII-76
Willow Wall Revetment.....	VII-78
Brush mattress.....	VII-79
Willow Siltation Baffles.....	VII-81
Planting Seedlings.....	VII-83
Checkdams.....	VII-86
Redwood Board Checkdams.....	VII-89

CALIFORNIA SALMONID STREAM HABITAT RESTORATION MANUAL

Brush Checkdams.....	VII-90
Brush and Rock Checkdam.....	VII-90
Post Brush Checkdam.....	VII-91
Tree Checkdam.....	VII-93
Brush and Rock Mattress Headcut Repair.....	VII-94
Waterbars.....	VII-96
Exclusionary Fencing.....	VII-97
REFERENCES.....	VII-98

PART VIII. PROJECT EVALUATION AND MONITORING

PROJECT EVALUATION AND MONITORING.....	VIII-1
Pre-Project Assessment and Data Collection.....	VIII-2
Historic Information.....	VIII-2
Pre-Project Information.....	VIII-2
Documentation Immediately Following Project Completion.....	VIII-3
Instructions for Completing the Project Site Completion Form.....	VIII-4
PROJECT SITE COMPLETION FORM.....	VIII-7
Post-Project Evaluation.....	VIII-8
Habitat Project Evaluation Forms.....	VIII-8
Equipment.....	VIII-9
Instructions for Completing the General Project Information Form.....	VIII-9
STREAM HABITAT ENHANCEMENT PROJECT EVALUATION	
GENERAL INFORMATION FORM.....	VIII-12
Instructions for Completing the Individual Structure or Site Form.....	VIII-13
STREAM HABITAT ENHANCEMENT PROJECT EVALUATION	
INDIVIDUAL STRUCTURE OR SITE FORM.....	VIII-17
Structure objective codes.....	VIII-18
Structure type codes.....	VIII-18
Construction method codes.....	VIII-20
SUMMARY.....	VIII-21

APPENDIX A.	POLICY AND REGULATIONS FOR SALMON AND STEELHEAD RESTORATION IN CALIFORNIA.....	A-1
APPENDIX B.	COOPERATIVE FISH PRODUCTION IN CALIFORNIA.....	B-1
APPENDIX C.	HYDROLOGIC BASIN PLANNING MAPS.....	C-1
APPENDIX D.	AERIAL PHOTO SOURCES.....	D-1
APPENDIX E.	LIST OF CALIFORNIA FISH SPECIES.....	E-1
APPENDIX F.	STATE AND FEDERAL ENDANGERED AND THREATENED SPECIES ASSOCIATED WITH SALMONID HABITAT.....	F-1

**CALIFORNIA SALMONID STREAM
HABITAT RESTORATION MANUAL**

APPENDIX G.	CONVERSIONS, MEASUREMENTS, AND ABBREVIATIONS..	G-1
APPENDIX H.	THE MANNING ROUGHNESS COEFFICIENT.....	H-1
APPENDIX I.	COMPUTER PROGRAMS AND DATABASE STRUCTURES.....	I-1
APPENDIX J.	STREAM INVENTORY REPORT.....	J-1
APPENDIX K.	TOOLS.....	K-1
APPENDIX L.	TWO-PIN METHOD.....	L-1
APPENDIX M.	SPECIALTY INSTRUMENTS.....	M-1
APPENDIX N.	PERMITS, AGREEMENTS, AND ENVIRONMENTAL DOCUMENTS.....	N-1
APPENDIX O.	TEN PERCENT SAMPLING PROTOCOL FOR HABITAT TYPING INVENTORY SURVEYS.....	O-1
APPENDIX P.	CALIFORNIA SALMONID FISHES.....	P-1
APPENDIX Q.	GLOSSARY.....	Q-1
APPENDIX R.	FORMS.....	R-1
APPENDIX S.	FISH SCREEN CRITERIA.....	S-1

VOLUME II

- PART IX. FISH PASSAGE EVALUATION AT STREAM CROSSINGS**
- PART X. UPSLOPE ASSESSMENT AND RESTORATION PRACTICES**
- PART XI. RIPARIAN HABITAT RESTORATION**
- PART XII. FISH PASSAGE DESIGN & IMPLEMENTATION**

**CALIFORNIA SALMONID STREAM
HABITAT RESTORATION MANUAL**

LIST OF FIGURES

Figure II 1.	Stream order designation (Strahler, 1957).....	II-3
Figure II 2.	Drainage area calculation.....	II-4
Figure II 3.	Diagrammatic representation of functional roles of riparian zones (Lamberti and Gregory, 1989).....	II-12
Figure II 4.	Hydro graph.....	II-16
Figure III 1.	Channel cross section.....	III-4
Figure III 2.	Entrenchment.....	III-5
Figure III 3.	Sinuosity.....	III-6
Figure III 4.	Relationship of different stream types.....	III-6
Figure III 5.	Key to classification of streams.....	III-7
Figure III 6.	Velocity crossover areas.....	III-22
Figure III 7.	Entrenchment determination.....	III-24
Figure III 8.	Habitat types hierarchy.....	III-28
Figure IV 1.	Coded-wire-tag recovery form.....	IV-10
Figure V 1.	Critical habitat needs. LSP represents all lateral scour pools. BWP represents all backwater pools. (McCain, Fuller, Decker, and Overton, 1990).....	V-19
Figure VI 1.	Longitudinal profile of channel bed depicting locations of possible enhancement sites.....	VI-13
Figure VI 2.	Selected cross-sectional profiles for reference pool, run, riffle features.....	VI-14
Figure VII 1.	Typical structures of variable height in the same stream reach create pool depths and deposition heights directly related to structural heights (Anderson, 1988).....	VII-4
Figure VII 2.	Comparison of level and sloping boulder face affect on flow into plunge pool (Overton, 1987).....	VII-5
Figure VII 3.	Cable secured to boulder using polyester resin adhesive.....	VII-11
Figure VII 4.	Cabling to log.....	VII-12
Figure VII 5.	Cable hook clamp.....	VII-13
Figure VII 6.	Tightening cable ends using two griphoists.....	VII-14
Figure VII 7.	Attach cable clamps to cables.....	VII-14
Figure VII 8.	A variation of the two-cable method.....	VII-15
Figure VII 9.	A variation of the two-cable method.....	VII-15
Figure VII 10.	Threaded rebar used to secure two logs together.....	VII-16
Figure VII 11.	Rebar anchoring application.....	VII-17
Figure VII 12.	Threaded rebar anchoring log to boulder, using polyester resin adhesive.....	VII-18
Figure VII 13.	Threaded rebar and cable anchor to boulder or bedrock.....	VII-19
Figure VII 14.	Expansion bolt into concrete.....	VII-20
Figure VII 15.	Trenching.....	VII-21
Figure VII 16.	Deadman.....	VII-22

CALIFORNIA SALMONID STREAM HABITAT RESTORATION MANUAL

Figure VII 17.	Divide log.....	VII-25
Figure VII 18.	Digger log.....	VII-26
Figure VII 19.	Spider logs.....	VII-27
Figure VII 20.	Log, root wad, and boulder combination.....	VII-28
Figure VII 21.	Downstream-V boulder weir.....	VII-30
Figure VII 22.	Vortex boulder weir, cross section view (Rosgen, 1993).....	VII-32
Figure VII 23.	Vortex boulder weir, plan view (Rosgen, 1993).....	VII-33
Figure VII 24.	Vortex boulder weir, profile view (Rosgen, 1993).....	VII-33
Figure VII 25.	Boulder cluster.....	VII-34
Figure VII 26.	Single and opposing boulder wing-deflectors.....	VII-35
Figure VII 27.	Straight log weir with low-flow notch.....	VII-37
Figure VII 28.	Downstream-V log weir.....	VII-38
Figure VII 29.	Diagonal log weir.....	VII-39
Figure VII 30.	Upstream-V log weir.....	VII-39
Figure VII 31.	Upstream-V log weir with a low-flow notch.....	VII-40
Figure VII 32.	Upstream-V log weir with a low-flow notch.....	VII-41
Figure VII 33.	Log constrictors over planks.....	VII-41
Figure VII 34.	Upsurge weir.....	VII-42
Figure VII 35.	Opposing log wing-deflector.....	VII-43
Figure VII 36.	Hewitt ramp.....	VII-45
Figure VII 37.	Movement of fish over natural obstacles (Stream Enhancement Guide, British Columbia Ministry of Environment, 1980, p. 27).....	VII-48
Figure VII 38.	Before and after blasting of falls and bedrock chute.....	VII-50
Figure VII 39.	Step-and-pool fishway.....	VII-53
Figure VII 40.	Denil fishway.....	VII-54
Figure VII 41.	Alaskan steep-pass.....	VII-55
Figure VII 42.	Back-flooding weirs.....	VII-56
Figure VII 43.	Washington baffles with a separator wall. (Stream Enhancement Guide, British Columbia Ministry of Environment, 1980, p. 42).....	VII-57
Figure VII 44.	Washington baffles. (Stream Enhancement Guide, British Columbia Ministry of Environment, 1980, p.42).....	VII-58
Figure VII 45.	Redwood Washington baffle construction.....	VII-59
Figure VII 46.	Steel Washington baffle.....	VII-60
Figure VII 47.	Corrugated metal pipe steel ramp baffles.....	VII-61
Figure VII 48.	Riprap.....	VII-65
Figure VII 49.	Boulder wing-deflector.....	VII-66
Figure VII 50.	Log cribbing.....	VII-68
Figure VII 51.	Live Vegetated Crib Wall (Schiechl and Stern, 1996).....	VII-69
Figure VII 52.	Log bank armor.....	VII-70
Figure VII 53.	Log wing-deflector.....	VII-72
Figure VII 54.	Tree revetment.....	VII-73
Figure VII 55.	Plan view of native material revetment (Rosgen, 1993).....	VII-74
Figure VII 56.	Native material revetment (Rosgen, 1993).....	VII-75
Figure VII 57.	Willow sprigging. (Prunuske, 1987).....	VII-77
Figure VII 58.	Willow Wall Revetment (L. Prunuske, 1997).....	VII-79
Figure VII 59.	Brush Mattress Plan View (L. Prunuske, 1997).....	VII-80

CALIFORNIA SALMONID STREAM HABITAT RESTORATION MANUAL

Figure VII 60.	Brush Mattress Cross Section (L. Prunuske, 1997).....	VII-80
Figure VII 61.	Arrangements of baffles (Schiechtl and Stern, 1996).....	VII-81
Figure VII 62.	Top view of baffles (Schiechtl and Stern, 1996).....	VII-82
Figure VII 63.	Side view of baffles (Schiechtl and Stern, 1996).....	VII-82
Figure VII 64.	Problems to avoid during tree planting.....	VII-84
Figure VII 65.	Steps in tree planting with hoedads. (California Department of Forestry, 1978).....	VII-85
Figure VII 66.	Tree planting. Planting bar method. (California Department of Forestry, 1978).....	VII-86
Figure VII 67.	Checkdam placement. (Prunuske, 1987).....	VII-87
Figure VII 68.	Redwood board checkdam. (Prunuske, 1987).....	VII-89
Figure VII 69.	Brush and Rock Checkdam (Kraebel and Pillsbury, 1934).....	VII-91
Figure VII 70.	Post Checkdam (Kraebel and Pillsbury, 1934).....	VII-92
Figure VII 71.	Tree Checkdam (Kraebel and Pillsbury, 1934).....	VII-93
Figure VII 72.	Brush and Rock Mattress (Kraebel and Pillsbury, 1934).....	VII-95
Figure VII 73.	Waterbar.....	VII-96
Figure H 1.	Longitudinal profile of a design reach, Tarup Creek, Del Norte County, California. (Inter-Fluve, Inc. 1984).....	H-4
Figure H 2.	Cross-sectional profiles of a reference pool and a selected design site, Tarup Creek, Del Norte County, California. (Inter-Fluve, Inc. 1984).....	H-5
Figure H 3.	Cross-sectional profile of a reference pool superimposed on a selected design site, Tarup Creek, Del Norte County, California (Inter-Fluve, Inc. 1984).....	H-6
Figure H 4.	Final cross-sectional design profile for station 42+23, Tarup Creek, Del Norte County, California. (Inter-Fluve, Inc. 1984).....	H-7
Figure L 1.	Location of the left bank end of a downed tree as determined by the intersection of the distances from two reference pins (Miller, O'Brien, Koonce, 1988).....	L-2
Figure L 2.	Typical to-scale plan schematic depicting existing (numbered) and prescribed (lettered) features relative to reference pins. Features correspond with those in Table L-1 (Miller, O'Brien, Koonce, 1988).....	L-3
Figure L 3.	Measured position quite far from reference pins results in an acute angle with a high potential for measurement error (Miller, O'Brien, Koonce, 1988).....	L-5

CALIFORNIA SALMONID STREAM HABITAT RESTORATION MANUAL

Figure L 4.	Reference pins should be placed well upstream and downstream of the area to be measured. In this way, the intersecting angle approaches 90 degrees (Miller, O'Brien, Koonce, 1988).....	L-6
Figure L 5.	Proper spacing of reference pins is slightly greater than twice the channel length (Miller, O'Brien, Koonce, 1988).....	L-7
Figure M 1.	Modified grid of convex spherical densiometer showing the 17 observations points (X's) and the position of the observer's eye reflection.....	M-6

CALIFORNIA SALMONID STREAM HABITAT RESTORATION MANUAL

LIST OF TABLES

Table V 1.	Summary of riffle, flatwater, and pool habitat types. Summarizes Level II riffle flatwater, and pool habitat types.....	V-3
Table V 2.	Summary of habitat types and measured parameters. Summarizes Level IV physical fish habitat of the stream surveyed. From this data, graphs can be generated to compare habitat types by percent occurrence, total length, percent total length, total volume, etc.....	V-5
Table V 3.	Summary of pool types. Summarizes Level III pool habitat types.....	V-7
Table V 4.	Summary of maximum pool depths by pool habitat types. Summarizes Level IV pool depths by habitat type.....	V-9
Table V 5.	Summary of mean percent cover by habitat type. In this example the majority of the cover consists of small and large woody debris.....	V-11
Table V 6.	Summary of dominant substrate by habitat type. Summarizes dominant substrate of Level IV habitat types. In this example the majority of substrates consist of sand and gravel.....	V-12
Table V 7.	Summary of Mean Percent Vegetative Cover for Entire Stream.....	V-13
Table V 8.	Fish Habitat Inventory Data Summary.....	V-13
Table V 9.	Mean Percentage of Dominant Substrate.....	V-14
Table V 10.	Mean Percent of Shelter Cover Types for Entire Stream.....	V-14
Table VII 1.	Selecting a checkdam type (Prunuske, 1987).....	VII-88
Table H 1.	Values of “n” to be used with the Manning equation.....	H-8
Table J 1.	Summary of riffle, flatwater, and pool habitat types.....	J-11
Table J 2.	Summary of habitat types and measured parameters.....	J-12
Table J 3.	Summary of pool types.....	J-13
Table J 4.	Summary of maximum pool depths by pool habitat types.....	J-14
Table J 5.	Summary of mean percent cover by habitat type.....	J-15
Table J 6.	Summary of dominant substrate by habitat type.....	J-16
Table J 7.	Fish habitat inventory data summary.....	J-17
Table L 1.	Measured distances and elevations of existing and prescribed structural components relative to the two reference pins at station 171+20 along Tarup Creek, Del Norte County, California. Existing features are described by numbers: prescribed features by letters: all corresponding with those in Figure 2. (Adapted from Inter-Fluve, 87).....	L-2
Table L 2.	Materials, with estimated dimensions and quantities, required for a station 171+20 along Tarup Creek, Del Norte County, California. The sources for individual items are indicated as available on-site, near to the site or through a specified supplier. Lettered items correspond with those in Figure L-2.....	L-4
Table P 1.	Temperature requirements, degrees Fahrenheit, for various life stages of salmon and steelhead (Reisner and Bjornn, 1979).....	P-11

CALIFORNIA SALMONID STREAM HABITAT RESTORATION MANUAL

LIST OF GRAPHS

Graph V 1.	Comparison of Level II habitat types by percent occurrence.....	V-4
Graph V 2.	Comparison of Level IV habitat types by percent occurrence.....	V-6
Graph V 3.	Comparison of Level III pool habitat types by percent occurrence.....	V-8
Graph V 4.	Summary of mean percent embeddedness of substrate in pool Trail.....	V-10
Graph J 1.	Habitat types by percent occurrence.....	J-18
Graph J 2.	Habitat types by percent total length.....	J-19
Graph J 3.	Habitat types by percent occurrence.....	J-20
Graph J 4.	Pool habitat types by percent occurrence.....	J-21
Graph J 5.	Maximum pool depths.....	J-22
Graph J 6.	Percent embeddedness.....	J-23
Graph J 7.	Mean percent cover types in pools.....	J-24
Graph J 8.	Substrate composition in low gradient riffles.....	J-25
Graph J 9.	Percent canopy.....	J-26
Graph J 10.	Dominant bank composition in survey reach.....	J-27
Graph J 11.	Dominant bank vegetation in survey reach.....	J-28

**CALIFORNIA SALMONID STREAM
HABITAT RESTORATION MANUAL**

DRAWINGS OF LEVEL IV HABITAT TYPES

LOW-GRADIENT RIFFLE (LGR).....	III-31
HIGH-GRADIENT RIFFLE (HGR).....	III-31
CASCADE (CAS).....	III-32
BEDROCK SHEET (BRS).....	III-32
POCKET WATER (POW).....	III-33
GLIDE (GLD).....	III-33
RUN (RUN).....	III-34
STEP RUN (SRN).....	III-34
EDGEWATER (EDW).....	III-35
TRENCH POOLS (TRP).....	III-35
MID-CHANNEL POOL (MCP).....	III-36
CHANNEL CONFLUENCE POOL (CCP).....	III-36
STEP POOL (STP).....	III-37
CORNER POOL (CRP).....	III-37
LATERAL SCOUR POOL - LOG ENHANCED (LSL).....	III-38
LATERAL SCOUR POOL - ROOT WAD ENHANCED (LSR).....	III-38
LATERAL SCOUR POOL - BEDROCK FORMED (LSB _k).....	III-39
LATERAL SCOUR POOL - BOULDER FORMED (LSB _o).....	III-39
PLUNGE POOL (PLP).....	III-40
SECONDARY CHANNEL POOL (SCP).....	III-40
BACKWATER POOL - BOULDER FORMED (BPB).....	III-41
BACKWATER POOL - ROOT WAD FORMED (BPR).....	III-41
BACKWATER POOL - LOG FORMED (BPL).....	III-42
DAMMED POOLS (DPL).....	III-42

CALIFORNIA SALMONID STREAM HABITAT RESTORATION MANUAL

ACKNOWLEDGEMENTS

The authors wish to thank the many individuals who contributed to this third edition of the *California Salmonid Stream Habitat Restoration Manual*, either directly in the text, or by innovation in techniques for fish habitat inventory or restoration. We especially thank Mike Byrne, John Fort, Ruth Goodfield, Alan Grass, Carl Harral, George Heise, Herb Pool, Linda Radford, Bob Snyder, Phil Warner of the Department of Fish and Game; Cindy Watanabe also of the Department of Fish and Game who did the computer generated diagrams; Jennifer Terwilliger of the California Conservation Corps for her editing and formatting; and Keith Zolezzi also of the CCC who produced the art and graphics. We are also grateful to Tim Farley, Chief, Inland Fisheries Division, for allowing us to postpone several other projects until this revised edition could be completed.

Special thanks go to David L. Rosgen for allowing us to freely use information contained in his work, *A Classification of Natural Rivers*, which establishes the methodologies used in this manual for stream channel classification; Evan Engber of BioEngineering Associates for his contributions about his bio-engineered erosion control; and Matt Smith of North Coast Fisheries for his innovative instream structure anchoring techniques.

Proposition 70 funds, through the support of the Proposition 70 Review Committee, provided the revenue to publish this manual, and deserve special recognition. Personnel funded by the Federal Sport Fish Restoration Act were instrumental in the production this edition.

CALIFORNIA SALMONID STREAM HABITAT RESTORATION MANUAL

FOREWORD

Over the past few decades, the field of fishery restoration has evolved into a full fledged specialty within the general context of environmental science. Writers on the subject have been prolific but the formal literature is broadly scattered and frequently contradictory. The Department of Fish Game has experienced an increasingly pressing need to define and explain its approach to fish restoration, and to describe acceptable and preferred methods. The Salmon, Steelhead Trout, and Anadromous Fisheries Program Act of 1988 (Chapter 1545/88) made restoration of anadromous fish state policy and placed a high priority on the program. The level of concern for these fish was demonstrated by the urgency clause attached to the legislation and in many subsequent State and Federal documents and proclamations.

In August, 1997, Senate Bill 271, by Senator Mike Thompson, created the Salmon and Steelhead Restoration Account. This provided significant multi-year funding for projects dedicated to the restoration of California's coastal salmon and steelhead watersheds and streams. SB 271 also provides DFG with the ability to grant funds to assess and improve watershed conditions impacting salmonid streams regardless of a problem's location in the watershed. This allows the restoration effort to better address "key" watershed impacts to include upslope and/or non-point source erosion sites deleterious to fish habitat. Furthermore, the legislation provided funding for coordinated planning, evaluation, and monitoring of restoration projects. This legislation also contained an urgency clause and was signed as such by Governor Pete Wilson.

This manual formally explains and describes the DFG ground level approach to restoration of fishery resources, and standardizes our descriptive terminology and technical methods. Principal emphasis is on salmon, steelhead, and trout; therefore this manual is principally intended to be used to assist in restoration efforts for those species in California. Although the process of habitat evaluation and basic restoration techniques are generally similar for California salmonids, their habitat preferences are frequently dissimilar. Therefore, applications must be selected that are suitable for the specific target species and life stage. The basic habitat assessment techniques are applicable for any fluvial fish species.

Disclaimer: This manual describes many methods and techniques used with varying degrees of success by habitat restoration specialists. The methods and techniques described here represent only a starting point for project design and implementation. They are not a surrogate for, nor should they be used in lieu of, a project design that has been developed and implemented according to the unique physical and biological characteristics of the site-specific landscape.

The techniques and methods described in this manual are not a surrogate for acquiring the services of appropriate professionals, including but not limited to licensed professional engineers or licensed professional geologists, where such expertise is called for by the Business and Professions Code section 6700 et seq. (Professional Engineers Act) and/or section 7800 et seq. (Geologists and Geophysicists Act).

**CALIFORNIA SALMONID STREAM
HABITAT RESTORATION MANUAL**

PART I

**SALMON AND STEELHEAD
HABITAT RESTORATION IN CALIFORNIA**



CALIFORNIA SALMONID STREAM HABITAT RESTORATION MANUAL

PART I SALMON AND STEELHEAD HABITAT RESTORATION IN CALIFORNIA

DEVELOPMENT OF CALIFORNIA'S PRESENT FISH HABITAT RESTORATION PROGRAM

Many Federal, State and local agencies, and Indian tribes, together with private interests, are actively involved in fish habitat improvement. Modern efforts to protect, restore, and improve fish habitat date back to the era immediately following statehood when hydraulic mining, gold dredging, and other destructive land use practices remained largely out of control. Laws prohibiting hydraulic mining and limiting many other potentially destructive land use practices had been passed before 1900, and land use controls have been gradually strengthened throughout the ensuing years. Truly comprehensive efforts to restore or improve fish habitat were coincident with the advent of the Civilian Conservation Corps in the 1930's and continued to grow with availability of Dingell-Johnson Act funds from the federal excise tax on fishing equipment.

In about 1979, the new state Forest Practices Act together with the Porter-Cologne Water Quality Act, California Environmental Quality Act, and the National Environmental Policy Act began to provide a strong basis for multi-disciplinary protection and improvement of fish habitat. The recent publications declaring the needs and benefits for an expanded program of salmon and steelhead restoration are summarized as follows:

An Environmental Tragedy - published in 1971 by the Citizen's Advisory Committee on Salmon and Steelhead Trout and the California Department of Fish and Game Staff Working Committee. This report documented 80 percent, 65 percent, and 64 percent decline in North Coast steelhead, coho and chinook runs, respectively, from 1940 to 1970. Sacramento-San Joaquin fall-run chinook experienced a 46 percent decline from 1953-1969. The report recommended aggressive action to halt the declines, which resulted in legislative action to protect stream habitat and upgrade hatcheries.

A Conservation Opportunity - published in 1972 by the Citizen's Advisory Committee on Salmon and Steelhead Trout and the California Department of Fish and Game Staff Working Committee. The report summarized legislative action taken to protect salmon and steelhead stocks. It also pointed out that fish managers and user groups needed to adopt an offensive, rather than a defensive program of fisheries management. Protecting and enhancing the resource should be stressed, rather than just reducing the losses. Major opportunities were identified in the areas of improving water quality, spawning gravel, watershed conditions, artificial fish rearing, and maintaining and enforcing scientifically sound catch regulations. Expanded Federal Anadromous Fish Act funding was recommended to help accomplish these goals.

The Time is Now - published in 1975 by the Citizens Advisory Committee on Salmon and Steelhead Trout, also known as the California Advisory Committee on Salmon and Steelhead Trout. This report summarized the recommendations and legislative actions of the first two reports and stressed that full restoration of fishery losses was needed immediately. It recommended artificial rearing projects, off-stream operations, better land use planning, expanded funding for fisheries from the State General Fund, and obtaining help from local governments in protecting fisheries.

CALIFORNIA SALMONID STREAM HABITAT RESTORATION MANUAL

A Prospectus For the Future - published in 1979 by the Resources Agency. This report described the Renewable Resources Investment Fund (RRIF) and how it will be used as a public investment in fisheries, forests, soils, parks, and water for future generations. In fisheries, it proposed an investment of \$25-35 million in salmon hatcheries and restoration over a 10-year period, and another \$25-35 million for habitat rehabilitation. The fishery goals were to double the salmon runs, add 600,000 fish to the annual salmon commercial fishery, 50,000 to the ocean sport fishery, and 50,000 to the river catch. This would be accomplished through artificial rearing, reconstructing spawning riffles, removing salmon migration blockages, improving stream flows, screening water diversions, and restoring watersheds. These goals were not achieved.

Investing For Prosperity - published in 1981 by the Resources Agency. This report described in detail the Geothermal Resources Fund, RRIF, and the Energy and Resources Fund. It mentioned that RRIF has been used to rear two million yearling salmon and that 100 miles of stream had been opened for salmon spawning by the California Conservation Corps. Additional fishery goals for the year 2000 were described, including increasing salmon and steelhead populations by 300,000 annually, and adding 600,000 adult salmon and steelhead annually to recreational and commercial fish landings, increasing wetland habitat from 500,000 to 750,000 acres, reopening 500 miles of salmon and steelhead habitat, acquiring 60,000 acres of key fish and wildlife habitat, restoring the Sacramento-San Joaquin Estuary fisheries, tripling the California annual oyster production, increasing abalone production by one million pounds, increasing the combined production of scallops, mussels, and clams by 100,000 pounds, providing an additional 100 million urban recreational fishing days, and improving the availability of fish and wildlife resource data. It also stated that Sikes Act funding would be supplemented with \$2 million in state funds annually for habitat improvement projects on U.S. Forest Service lands. Few of these goals were achieved.

Investing For Prosperity - An update was published by the Resources Agency in 1982. It described the 20-year plan and provided status reports of program implementation including proposed special fund expenditures for expanding Nimbus Hatchery, salmon and steelhead habitat restoration, habitat acquisition and improvement, artificial reef construction, Salton Sea Resources Utilization Plan, shellfish habitat development and enhancement, wildlife and fish habitat relationships program, and kelp restoration.

The Tragedy Continues - published in 1986 by the California Advisory Committee on Salmon and Steelhead Trout. The earlier findings of the Citizens Advisory Committee on Salmon and Steelhead Trout are updated. The conclusions are: 1) Salmon and steelhead production and utilization are important parts of the state's economy; 2) There has been a significant loss or degradation of suitable habitat and a resulting reduction in production; 3) Immediate action must be taken to begin to reverse these trends and restore this valuable resource. The report discusses issues that should be incorporated in a management and restoration plan and lists issues recommended for legislative action. The report states in reference to habitat: "Specifically, it is almost always more cost effective to prevent damages than to clean up afterward." and: "It is extremely important to base restoration efforts on a sound plan, beginning at the state level, as the need for restoration of salmonid populations is urgent and only limited resources are available for the task."

Restoring the Balance - published in 1988 by the California Advisory Committee on Salmon and Steelhead Trout. This report once again identified salmon and steelhead conservation problems and

CALIFORNIA SALMONID STREAM HABITAT RESTORATION MANUAL

restoration opportunities. Problems and opportunities in this report were grouped by watershed. A focused, well-managed program of habitat protection and repair was proposed. It would require changes in water allocation policies and practices so that adequate stream flow and appropriate water temperatures would be provided for salmon and steelhead throughout the year. Also the need for innovative education programs to inspire environmental awareness was proposed. This report led to the passage of "The Salmon, Steelhead Trout, and Anadromous Fisheries Program Act".

The present program is the product of the State's efforts to comply with both federal and State legal and policy requirements and directives. Those laws and policies that most directly influence fish habitat restoration activities in California are included for reference in Appendix A.

ORGANIZATION AND FUNDING OF CALIFORNIA'S FISH HABITAT RESTORATION PROGRAM

Fisheries management and habitat restoration in California are principally responsibilities of the California Department of Fish and Game (DFG). Other agencies active in the effort include the California Conservation Corps (CCC), California Department of Transportation (CALTRANS), California Department of Forestry and Fire Protection (CDF), California Department of Water Resources (DWR), Regional Water Quality Control Boards (RWQCB), Environmental Protection Agency (EPA), United States Fish and Wildlife Service (USFWS), National Marine Fisheries Service (NMFS), United States Forest Service (USFS), United States Bureau of Land Management (BLM), AmeriCorps, Natural Resources Conservation Service (NRCS), County Resource Conservation Districts (RCD=s) and numerous local agencies. The DFG program is centrally administered through Inland Fisheries Division and includes seven administrative regions responsible for fish management, production, and habitat in their respective geographic areas.

Initial efforts were almost entirely funded under the Federal Aid in Sport Fishing Restoration Act, using Federal funds from excise taxes on sporting equipment. In 1980, the Energy and Resources Fund was used to contract with CCC to set up a cooperative fisheries restoration project. This million-dollar-a-year program has continued to the present. Passage of the Bosco-Keene Assembly Bill 951 in 1981 made an additional \$1 million available for cooperative fish restoration projects. Since the early days of the salmon restoration effort there has been a series of funding sources including: Senate Bill 400, Assembly Bill 1705, Propositions 19, 70 and 99, Commercial Salmon Trollers= Enhancement Fund, Steelhead Report Card, and most recently Senate Bill 271, authored by Senator Mike Thompson.

Currently, public funding for fish habitat and fish rearing programs can come from sales of angling licenses and stamps, permit fees, federal excise taxes on angling equipment and items associated with angling, penalty assessments, the State General Fund, sales of environmental license plates, transfer of funds to the Fisheries Restoration Account through the state budget act, mitigation accounts, and statewide initiatives specifying fish habitat as a beneficiary.

Over the years, funding for restoration work has also been supported by private sector cooperative efforts that have involved matching funds, in-kind contributions, and volunteer efforts. Today, this concept of cooperation between the public and private sectors is a growing and powerful force in watershed restoration in California.

CALIFORNIA SALMONID STREAM HABITAT RESTORATION MANUAL

This pool of funds and effort has sustained the DFG stream habitat restoration program. The level of expertise of both public and private cooperators has increased significantly and a high-quality program that incorporates the best in public and government involvement and commitment has emerged in California. However, the task of restoring California's watersheds and anadromous fisheries remains formidable and can only be successful with greatly increased public and private cooperation and commitment.

FISHERY RESTORATION PLANNING OBJECTIVES

Prior to planning a fishery restoration program or project, a clear definition of the problem or issue to be addressed must be developed. Next, and often a more difficult step, clearly identifiable objectives that reflect the intent and capabilities of the proponent must be developed. Those objectives must be clearly developed to enable formulation of an appropriate, detailed work proposal. They will dictate the type and level of pre-project inventories necessary to assess the present condition of the fish resource and to estimate the probable benefit of the proposed work. In the Eel and Russian rivers the Department of Fish and Game (Department) has established Basin Planning Projects (BPP) to facilitate and/or conduct these and other planning activities. These two projects are producing tributary reports with restoration recommendations, and general basin plans within their respective watersheds. DFG is currently expanding its basin planning efforts based upon the progress made by these projects. The Salmon Restoration Project (SRP), based in Fortuna, also conducts tributary inventory activities throughout the State. Additionally, the Department has recently produced a statewide steelhead management plan to provide general guidance for improving that fishery.

The design of fish habitat restoration projects requires identification of the specific habitat factors limiting fish production, beginning with the factor most critically affecting the final quantity and quality of adult fish produced. Identification of the critical habitat needs for the fishery under consideration, through file searches or new field studies, will determine the scope, direction and probable monetary investment required to meet project objectives. The methods described in this manual will help the planner identify critical fish habitat needs, develop suitable restoration work plans, and determine the appropriate level of post-project evaluation and monitoring needed to assess the effectiveness of the work.

**CALIFORNIA SALMONID STREAM
HABITAT RESTORATION MANUAL**

PART II

PRELIMINARY WATERSHED ASSESSMENT



CALIFORNIA SALMONID STREAM HABITAT RESTORATION MANUAL

PART II PRELIMINARY WATERSHED ASSESSMENT

To get the big picture relative to present and potential fish production in a stream or stream system it is necessary to first understand the processes at work in the watershed. Geology, topography, precipitation, soils, vegetation, and human impacts working together comprise the watershed. Watershed is defined as the total land area draining to any point in a stream, as measured on a map, an aerial photo or other horizontal plane. A watershed can also be called a catchment area, a drainage area, or a basin.

An important part of any watershed assessment includes becoming familiar with various types of maps and their uses, historical stream surveys, literature and file reports on sediment sources, hydrology, water appropriations and impoundments, timber and other resources, management practices, and with zoning or other restrictions. This should be accomplished before entering into a formal field survey.

The data gathered in the watershed assessment will:

- Provide basic information on past and present land and other natural resources management, and on present and potential fish production;
- Provide statistical information on water and fish habitat quantity and quality;
- Aid in assessing needs for additional studies;
- Provide a basis for development of fish habitat or artificial production projects and necessary project evaluation procedures.

WATERSHED OVERVIEW

Often, most of the information necessary for a watershed assessment can be gathered prior to going into the field. This information can be entered on the "Watershed Overview Work Sheet," then entered into a database for analysis and storage. If a computer is to be used for storage and analysis, a dBASE IV file, Watershd.dbf, is available from Inland Fisheries Division on diskette. The database structure is described in Appendix I.

CALIFORNIA SALMONID STREAM HABITAT RESTORATION MANUAL

Tools and Supplies

- Maps and aerial photographs. United States Geological Survey (USGS) 7.5-minute topographic maps (quadrangles) are the minimum required.
- Planimeter
- Map measuring tool (map wheel)
- Topographic map template (dot grid overlay)
- Latitude and longitude calculator (Coordinator brand)
- Calculator
- Computer
- Watershed Overview Work Sheet

Instructions for Completing the Watershed Overview Work Sheet

- 1) **Date** - Enter the day's date (mm/dd/yy).
- 2) **Investigator** - Enter the name of the person responsible for the data on the work sheet.
- 3) **Stream Name** - Name of the stream as it appears on the 7.5-minute USGS quadrangle.
- 4) **PNMCD:** Enter the official numeric code for the stream according to the EPA River Reach File. EPA River Reach file is available by writing to:

Office of Wetlands, Oceans and Watersheds
Assessment and Watershed Protection Division
401 M Street
S.W. Washington, D.C. 20240.
- 5-8) **Tributary to** - Starting at the subject stream's mouth working downstream to the ocean or a terminal lake, describe the downstream tributary system. Examples: 1) Hollow Tree Creek, tributary to the South Fork Eel River, tributary to Eel River; 2) Eel River, tributary to the Pacific Ocean.
- 9) **County** - Record the county or counties through which the stream flows.
- 10) **USGS Map** - Enter the name(s) of the 7.5-minute USGS quadrangle containing the stream surveyed beginning at the mouth and progressing to the headwaters.
- 11) **Location** - Record township, range, and section (preferably quarter section) at the mouth of the stream, or at the lowest point of the stream reach surveyed. Also record the latitude and longitude of the survey starting point. This information can be derived from the 7.5-minute USGS quadrangle using the Coordinator tool (Appendix M).

CALIFORNIA SALMONID STREAM HABITAT RESTORATION MANUAL

- 12) **Access** - Describe the route used to access the stream or stream reach surveyed. Mention trails, roads, locked gates, who controls the gates and a phone number, if possible. List any other special access considerations. Use the other side of the sheet, if needed.
- 13) **Hydrologic Basin Planning Delineation** - The State Water Resources Control Board (State Board), Regional Water Quality Control Boards (Regional Boards), the Department of Water Resources, and the USGS have agreed on a standard method of delineating surface water drainage areas in California. Enter the 5 digit Hydrologic Sub Area Number (HSA) from the Water Resources Control Board hydrologic basin planning maps. See Appendix C for information on the maps and where to get copies.
- 14) **Aerial Photos** - Enter the photo numbers, years, and source of any available aerial photos. A list of sources for aerial photos is given in Appendix D.
- 15) **Stream Order** - Stream order is a classification based on the branching pattern of river systems (Strahler 1957). A first order stream is defined as the smallest un-branched tributary to appear on a 7.5-minute USGS quadrangle (1:24,000 scale) (Leopold et al. 1964). This system includes only perennial streams (i.e. those with sufficient flow to develop biota). When two first order streams join, they form a second order stream. Then, when two second order streams join, they result in a third order stream; and as streams of equal order meet they result in a stream of the next higher order (Figure II-1).

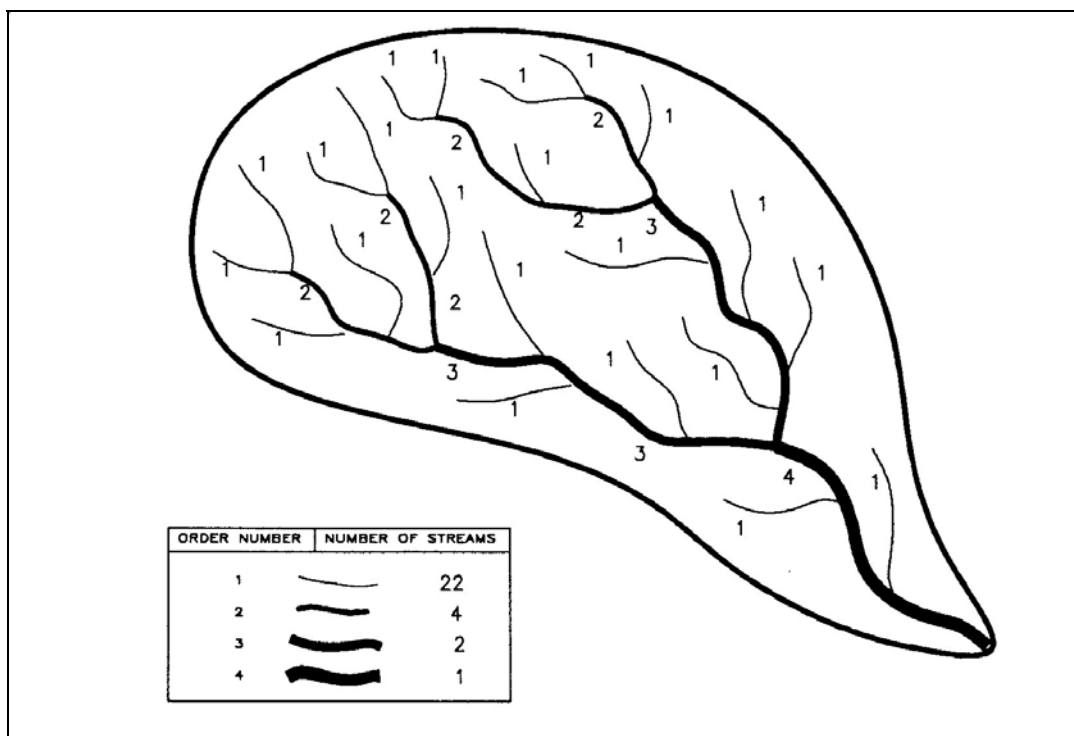

Figure II-1. Stream order designation (Strahler, 1957).

CALIFORNIA SALMONID STREAM HABITAT RESTORATION MANUAL

- 16) **Total Length** - Enter the total length of the perennial stream. This can be approximated using a map measure and a 7.5-minute USGS quadrangle.
- 17) **Drainage Area** - The drainage area includes all area that drains to the subject body of water. Drainage divides follow ridges and saddles and cross contour lines at right angles (Figure II-2). Compute the total drainage area in square miles using a planimeter, or a dot grid overlay, available from most drafting supply stores, and a 7.5-minute USGS quadrangle.

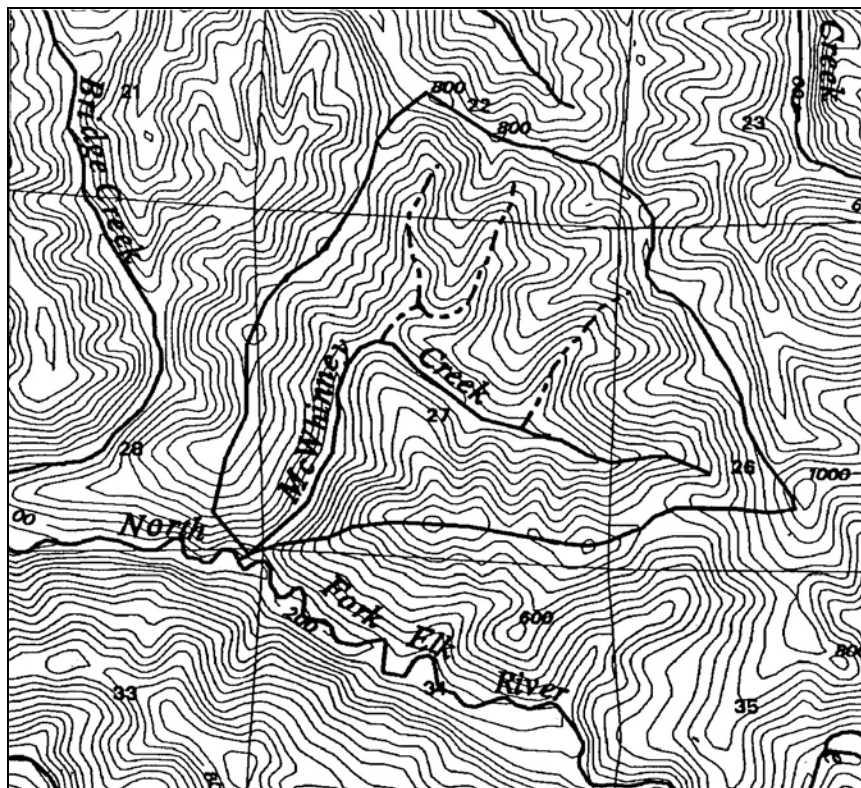

Figure II-2. Drainage area calculation.

- 18) **Summer Base Flow** - Summer base flow, as used here, is the lowest flow recorded in a given year. If base flow information is available, record it in cubic feet per second (cfs). Enter the source of your information; whether it was an estimate of the flow, or measured with an instrument; and the date of the sample.
- 19) **Elevations** - Record the elevation at the stream's mouth and the approximate elevation of the headwater areas at the basin crest. These elevations can be obtained from USGS topographic maps.
- 20) **Lakes in Watershed** - Record the number and square miles of lakes in the watershed (preferably using a 7.5-minute USGS quadrangle and a planimeter).

CALIFORNIA SALMONID STREAM HABITAT RESTORATION MANUAL

- 21) **Fish Species** - List the fish species known to exist in the stream using existing surveys on file with DFG, USFS, etc. This may be updated if found to be incorrect, or if conditions are found to have changed since the previous surveys. Use the abbreviations for names of fishes and invertebrates found in Appendix E. Also include data source, survey technique, and date. For example: DFG files Eureka, electrofishing, 1991.
- 22) **Endangered/Threatened/Sensitive Species** - Record any listed species known to exist in this watershed. Include your data source and date. The State of California "List of State and Federal Endangered and Threatened Fishes and Crustaceans," (Revised October 1996) is included as Appendix F. This list is maintained by DFG Natural Heritage Division (NHD) and is revised quarterly (January, April, July, and October). Current copies of the list may be obtained from NHD or other divisions and regional offices. In addition all species identified in "Fish Species of Special Concern of California" by Moyle, Williams, and Wikramanayake need to be considered as well as other aquatic species included on the "Special Animals" list maintained by the Natural Diversity Data Base (NDDB) in NHD.
- 23) **Endemic Stocks** - Endemic stocks are defined as "only historic naturally reproducing fish originating from the same stream or tributary." If the stream is known to have an endemic stock, specify the fish species and the data source and date.
- 24) **Fishery Management Concepts** - Record the management which best describes the stream. In some cases there may be more than one. This information is available by contacting the DFG District Biologist.
- Cold Water: All cold water non-anadromous fish species.
 - Anadromous: Any fish species that migrates upstream from the ocean to spawn.
 - Warm Water: All warm water fish species.
 - Natural Production: Naturally reproducing stocks from the drainage or from stocks outside the basin of which the stream is part.
 - Mixed Production: Stocks include natural production and hatchery produced fish from streams within or from outside the basin.
 - Other: If there is a special circumstance that does not fit into any of the above categories. Be specific.
- 25) **Stream Flow Data** - If flow data has been collected enter **T** for true or, if not enter **F** for false. A list of gauging stations is available from the Department of Water Resources. Other potential sources for flow data include the USGS, USFS, DFG, local water districts, power authorities, and private consulting firms. Enter the source and date of your information.
- 26) **Water Quality Data** - Enter **T** if data has been collected, or **F** if it has not been collected on that watershed. If true enter the source and date of your information.

CALIFORNIA SALMONID STREAM HABITAT RESTORATION MANUAL

- 27) **Ownership - Federal, State, Private** - Measure and enter the total stream miles that are federal, state, or privately owned. This information can be obtained from the county parcel maps at the county courthouse. Add any pertinent information such as "the entire watershed is under ownership of one timber company," or "there are multiple private landowners," etc.
- 28) **Major Land Uses in Watershed** - Enter major uses with the codes listed below in parentheses. More than one code can be used. These codes correspond with entry fields in the DFG Watershd.dbf database, described in Appendix I.
- (1) Road development
 - (1a) Paved roads
 - (1b) Unpaved roads
 - (2) Timber harvest
 - (3) Mining
 - (3a) Open pit
 - (3b) Hard rock
 - (3c) Suction dredge
 - (4) Agriculture
 - (4a) Livestock grazing
 - (4b) Land under cultivation
 - (5) Wilderness
 - (5a) Federal wilderness area
 - (5b) State park or wilderness area
 - (6) Water developments
 - (6a) Large hydroelectric facility
 - (6b) Small hydroelectric facility
 - (6c) Diversion
 - (6c1) Water exported out of basin
 - (6c2) In basin
 - ! (7) Developed recreation
 - (7a) Ski areas
 - (7b) Campgrounds
 - (8) Dispersed recreation
 - (9) Urbanization
 - (10) Off highway vehicle area
 - (11) Other, explain in additional information
- 29) **Comments** - Enter comments required to clarify any entries.

WATERSHED OVERVIEW WORK SHEET

Date _____ / _____ / _____ Investigator _____

Stream Name _____ PNMCD _____

Tributary to _____ Tributary to _____

Tributary to _____ Tributary to _____

County _____ USGS Quad _____

Location T _____ R _____ S _____ Latitude _____ Longitude _____

Access Via _____

Hydrologic Boundary Delineation _____

Aerial Photos (Source) _____

Stream Order _____ Total Length _____ miles

Drainage Area _____ sq. mi. Summer Base Flow _____ cfs

Elevations Mouth _____ feet Headwaters _____ feet

Lakes in Watershed Number _____ Surface Area _____ sq. mi.

Fish Species (Data Source) _____,

_____, _____,

Endangered / Threatened / Sensitive Species (Data Source)

_____, _____,

Endemic Stocks (Data Source) _____

Fishery Management Concept Cold Water: Natural Production _____

Mixed Production _____

Anadromous: Natural Production _____

Mixed Production _____

Warm Water: _____

Other: _____

Stream Flow Data (Source) _____

Water Quality Data (Source) _____

Ownerships in Stream Mi. Federal _____ State _____ Private _____

Additional Information _____

Major Land Uses in the Watershed: _____, _____, _____, _____, _____

Additional Information _____

Comments _____

CALIFORNIA SALMONID STREAM HABITAT RESTORATION MANUAL

MAPS AND THEIR USES

Maps are among the most basic sources of watershed information. There are many types of maps, each depicting its own set of information on a watershed. The more useful types include geologic, topographic, soils and vegetation, land use, and isohyetal maps.

Geological survey maps show the general geologic and other significant land form and landmark features in a watershed. They are available directly from USGS. University libraries usually have a good selection of USGS maps, both topographic and geological.

Topographic maps use elevation contours, which are lines joining areas of equal elevation to show total relief, slopes, and drainage patterns. Topographic maps, such as the USGS 7.5 and 15 minute series, also indicate streams, lakes, and major human features such as roads, railroads, and settlements.

Soils and vegetation maps are available from the United States Natural Resources Conservation Service (NRCS). A knowledge of soil types in a watershed will help understand and evaluate infiltration, runoff, slope stability, and soil susceptibility to erosion. Vegetation found in an area depends on soil type, climate (precipitation and temperature), topography, and natural or human surface disturbances. The combination of geology, topography, soils, climate, vegetation, and disturbance determines slope stability. Modification of vegetation by fire, logging, ranching, road building, or other disturbances can increase erosion and have severe consequences to soils, runoff, and groundwater storage capacity in a watershed.

Land use and ownership maps can help identify human activities which may have major impacts on a watershed. National Forest maps indicate boundaries between federally owned forest land and private land or other lands. BLM also can provide very good land ownership maps. Common human activities that can disturb a watershed include mining, grazing, timber harvest, agriculture, recreation, and urbanization. Knowing land uses in a basin will provide general comprehension of the present and probable future human impacts on the drainage. Ownership maps will indicate parties responsible for management of land within the watershed, and the initial contact for access permission for field surveys or restoration project construction.

Isohyetal maps depict average yearly precipitation rates for specific areas within a watershed. Lines on the map join areas of equal precipitation and basic human and geographic features are usually shown. Used in conjunction with precipitation charts for a weather station in or near the watershed, it is possible to estimate the total amount, intensity and seasonality of precipitation. This data can then be used to predict the timing and magnitude of normal annual stream discharge, or normal frequency of exceptionally high or low flows in any given time period.

CALIFORNIA SALMONID STREAM HABITAT RESTORATION MANUAL

USGS publishes an index to topographic and other map coverage. This index and the different types of maps published by USGS may be obtained from:

Western Mapping Center
U.S. Geological Survey
345 Middlefield Road
Menlo Park, CA 94025

AERIAL PHOTO INTERPRETATION: HISTORICAL SEQUENCE

Aerial photographs (air photos) present the view looking straight down from an aircraft to the ground. Orthophotoquads are black-and-white photo images prepared from air photos that have been adjusted to eliminate image displacement.

Image displacement is caused by distortion of distances near the edge of air photos. This distortion occurs because the center of the photo is directly underneath the camera in the airplane but the edges of the photo are not. This causes a slight distortion of the distances at the edge of the photo (they appear slightly longer as compared to distances at the center of the photo). Therefore, there is a slight difference in the scale at the edge of the photo compared to the center.

Orthophotomaps are multicolor orthophotoquads which have had extensive cartographic treatment including contours, lettering, and some symbols. Orthophotoquads, orthophotomaps, and aerial photographs are especially valuable when used in conjunction with topographic maps, soils and vegetation maps, and geologic maps.

Historical photo sequences from earliest to most recent can provide an important perspective and greatly add to understanding present conditions in a watershed. By inspecting photo sequences of an area from the oldest to the most recent, a careful observer can obtain an overview of natural or human induced land disturbances, and of changes in land uses and vegetation. Stereo images which can be produced optically by viewing overlapping photos through a stereoscope are especially good for observing topography, mass erosion sites and riparian areas.

Significant factors or possible resource problems that can be revealed through review of aerial photos include large burned areas, dams and diversions, urbanization, roads, stream crossings, landslides and their possible causes, other major erosion areas, timber management practices, riparian vegetation, stream channels, estuarine areas, and altered drainage patterns. These and other observed phenomena can have major impacts on a fishery resource. A review of this kind can suggest possible fishery restoration or production priorities before ever stepping into the field. However, field review is certainly a necessary next step to verify suspected watershed problems before any prioritization or design can occur.

USFS and private timber companies with large land holdings keep up to date inventories of air photos covering their lands. Private air photo companies, county planning departments, municipal water districts, CDF, DFG, city and county planning departments, Indian reservations, local colleges and universities, NRCS, BLM, and other natural resource agencies are all potential sources of air photos. See Appendix D for a list of aerial photographic sources.

CALIFORNIA SALMONID STREAM HABITAT RESTORATION MANUAL

HISTORICAL STREAM SURVEY REVIEW

After completing a map and air photo assessment, a thorough review of previous surveys that have been conducted on the project stream is in order. This review will summarize information currently available from various agencies on the history of the stream and will provide important background for development of a restoration or enhancement plan.

Most state and federal agencies that manage fisheries have a file of old stream surveys for every stream in their jurisdiction. These surveys can have a variety of formats and may be confusing to the inexperienced person. In most cases useful information can be obtained from them. For example, virtually all surveys include a rough description of the fish habitat accessibility and availability, usually in the form of migration barrier locations and a pool to riffle (P:R) ratio. In addition, surveys usually give an indication of the species and sizes of fish that occupy a stream and their relative abundance. These are typically very rough estimates and it should not be assumed that all stream surveys are accurate. However, they can be useful indicators of what to expect during the stream inventory.

Many stream surveys have a hand-drawn or photocopied map included with them on which various physical stream characteristics are located. Some items which can prove to be important and should be carefully noted are survey access points, tributary confluences, and other land features which can provide location points. Other physical features which are often included on the map or in the text of the survey, and which are important to note are: fish migration barriers, road crossings, water diversions, major landslides, log debris accumulations, dams, etc. The condition and size of the features as well as the date of the survey on which they were first identified should be noted. Information from previous surveys can be very useful for purposes of comparison when the stream inventory is conducted. Some previously reported problems, especially fish migration barriers, could be high priority treatment sites for habitat restoration activity and should be verified during the habitat survey.

WATER

The most basic habitat requirement for salmonids is water. As the human population of California increases, there is a growing demand for water for human needs. Even in rural watersheds the number and degree of water extractions from streams or ground water can impact flows needed to sustain fish. Landowners and managers can "own" water rights granted by the State Water Resources Control Board. A water right can be in the form of deeded access to a spring, for example, or an impoundment, a "riparian" water right, or an agricultural stream diversion. They are granted in terms of pipe flow, cubic feet per second, or even in acre feet per year. Additionally, in some areas of rural California, a considerable amount of water is taken from small streams without a water right.

All these extractions have an effect on the aquatic system (in some cases de-watering small streams in summer) so it is important to determine the extent of water use within a watershed. The California Department of Water Resources (DWR) maintains impoundment and diversion records,

CALIFORNIA SALMONID STREAM HABITAT RESTORATION MANUAL

which are available in report, database, or Geographical Information System (GIS) formats. The Water Resources Control Board grants water rights and maintains those records. The State and Regional Water Quality Control Boards are also useful sources of watershed information.

RIPARIAN ZONE

The riparian zone borders the stream and is the transition area to the upper watershed. The zone interacts with the channel and bears strongly on the structure and function of the aquatic ecosystem. The structure and composition of the riparian zone can be affected by the stream type and its active channel, as well as by geologic and topographic features (Figure II-3).

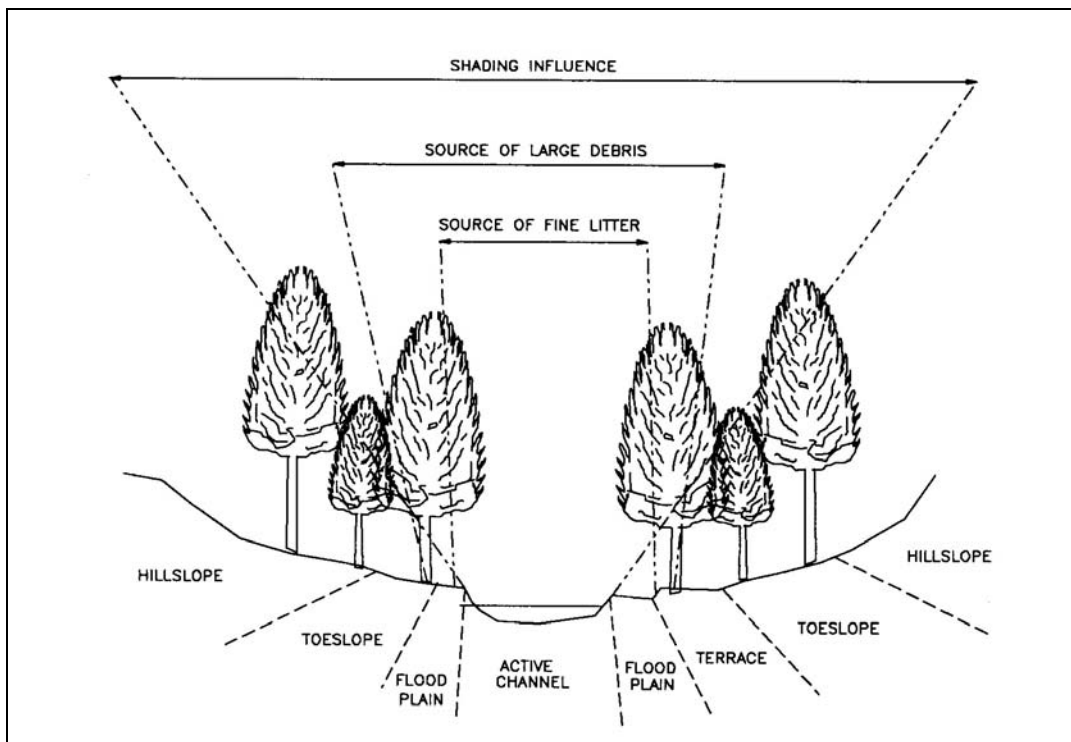

Figure II-3. Diagrammatic representation of functional roles of riparian zones (Lamberti and Gregory, 1989).

Functions of the riparian zone include:

- Controlling the amount of light reaching the stream which affects temperature and productivity.
- Providing litter and invertebrate fall.
- Providing stream bank cohesion and buffering impacts from adjacent uplands.
- Providing large woody debris.

CALIFORNIA SALMONID STREAM HABITAT RESTORATION MANUAL

For most practical purposes the riparian zone can be considered the terrestrial component of the stream environment. Riparian zones are typically subject to partial or complete flooding and riparian vegetation is adapted to the particular climatic and topographic attributes of the zone. Riparian zones are the links between the terrestrial and aquatic ecosystems. An extremely close relationship exists between the riparian zone, the fluvial processes of the channel, and fish habitat.

Management of streams for fisheries resources must include the riparian zone as a vital part of the stream ecosystem. In addition to Fish and Game Code Section 1600 rules (Part VI), the importance of this near-stream zone has led the Board of Forestry (BOF) to designate it as a Watercourse and Lake Protection Zone (WLPZ). The BOF has developed protection rules that regulate near-stream timber harvest activities. These rules are subject to periodic review, evaluation, and revision.

Recruitment of large trees into stream systems as structural elements is becoming less commonplace and is cause for concern for the future of this vital fish habitat component. Reduction of riparian vegetation can also result in decreased stream bank stability and increased channel width. The result can be widening and braiding of the channel, loss of channel structure and fish habitat, and subsurface flow during the summer low flow season. It is imperative to recognize the importance of the riparian zone and include it in any stream habitat restoration effort.

SEDIMENT SOURCES

Sediment is an important and vital component of instream fish habitat. Salmonids are dependent upon sorted and well distributed gravel reaches to spawn successfully. The gravel must be reasonably free of fine sediment in order for eggs and embryo to survive and emerge as fry. Young fry further depend on gravel and cobble interstices for escape cover.

In an undisturbed watershed, the stream sediment budget exists in dynamic equilibrium. Human activity in a watershed usually disturbs the natural supply rate of sediment from its sources, as well as the rapidity with which sediments move through a stream system. Dam construction, for example, reduces the supply of sediment to a stream and can limit transport flows. Poor road construction and maintenance usually increase rates of sediment delivered to streams and increase runoff rates.

Human land use activities, especially roads, as well as natural geologic and soil conditions, affect sediment production and can have a major impact on the floodplain and stream channel form and flow pattern. Channel form and pattern are key factors affecting fish habitat. Increased sediment yield to streams, if not scoured by seasonal flows, can result in streambed aggradation and development of severe stream bank instability. As sediments are deposited, the stream channel is forced to widen as the substrate surface level rises. When the channel width increases, the stream shallows and the surface area exposed to the sun increases in relation to the volume of water. Solar heating is increased and higher water temperatures result. This causes changes in habitat suitability, species composition and aquatic biomass.

In an active streambed, gravel, cobble, boulders, and organic debris that form critical components of fish habitat must be continuously replenished from upland or near stream sources

CALIFORNIA SALMONID STREAM HABITAT RESTORATION MANUAL

since they are transient and move through the stream system during transport flows. It is possible to determine the dominant sediment sources in a watershed by a combination of aerial photograph analysis and field inspection of road and stream bank conditions. Geologic and soil maps can also be very useful in this determination.

Sediment is derived from three primary sources in a watershed: 1) mass wasting (or landslides) in which soil, rock, and other debris are moved down slope by gravity; 2) surface erosion in which finer materials are transported by wind or overland flow of water when precipitation exceeds the infiltration capacity of the soil; 3) stream bank and stream channel erosion in which erosion products are washed from the streambed, banks, or overflow areas by stream flow.

Mass Wasting

Mass wasting may be categorized as either shallow or deep seated, and is often triggered by an undercut of a slope and/or a buildup of soil-water pressure during heavy rains. The stability of a slope can be reduced by expansion and contraction from periodic freezing or supersaturation, ground disturbance, or changes in vegetation. The location of historic, active, and potential landslides can often be determined from aerial photographs. Ground reconnaissance can determine the volume and stability of landslides as well as the dominant particle size originating from the slide.

There are many types of mass movement, any of which might be called a landslide. Landslides come in all sizes and shapes, and their movement may be sudden and extremely rapid occurrences, or they may be imperceptible except for the debris deposition at their toe. These slow moving, long-term landslides take many forms but are often slumps or earth avalanches that can be identified by curved head wall scarps, crooked or "jackstrawed" trees, or cracks in the soil. Mass wasting can be greatly accelerated by human land use within a watershed, particularly in relationship to road systems and other earth disturbance activities.

Surface Erosion

Diversion or capture of streams and storm runoff by roads or other disturbed or excavated areas can cause greatly accelerated erosion in the form of rills, gullies, landslides, enlarged stream channels, or even new stream channels. Extensive study has determined that the majority, in some cases as much as 70 percent, of eroded sediment is caused by watershed road systems. For example, blocked culverts are a common feature that can divert water onto a road, or into its inboard ditch until it breaks across the roadway, often causing massive erosion on the road and both the uphill and downhill slopes it encounters. Surface erosion from unconsolidated sources such as overland flow during very heavy downpours or rapid melting of hail or snow, or strong wind usually results in movement of sand-sized or smaller sediments in a form called sheet erosion. Altered drainage patterns and widening of storm runoff channels can be identified from analysis of a sequence of air photos taken over a number of years and from ground inspection of drainage patterns where they are intercepted by roadways or other disturbance.

CALIFORNIA SALMONID STREAM HABITAT RESTORATION MANUAL

Heavy grazing, fire, or other surface disturbance can also accelerate surface erosion. Because this erosion tends to be more uniformly distributed over the land surface, it is often difficult to recognize or quantify.

Stream and Channel Erosion

Erosion is the natural process that cuts stream channels, and can form river canyons and create river valleys. The rate of erosion is generally determined by the stream gradient and the resistance of the channel material. Obstructions to flow in the channel can accelerate stream bank erosion as flows are redirected. Mass side slope erosion is typically triggered by stream bank erosion undercutting unstable slopes and can add substantially to bedload.

The erosion process is continuous and self-renewing from the uppermost slopes down through the valley floors and estuaries. Down cutting, meander, aggradation and deposition are all natural erosion processes that must be given careful consideration as part of a fish habitat inventory or evaluation.

HYDROGRAPHS

For all gauged streams a hydrograph can be generated. A hydrograph is a graph showing, for a given point on a stream, the discharge, stage, velocity, or other property of water with respect to time. A hydrograph may be made for daily, monthly, or annual discharges. Depiction of long periods such as an annual hydrograph can be used to determine low flow, summer base flow, winter base flow, and flood discharges (Figure II-4). A list of stream flow gauging stations is available from the California Department of Water Resources. Gauging station data is usually available in university libraries as well.

Salmonids are dependent upon different flows during various life stages, and their presence, absence, and movements are influenced by flows. Therefore, hydrographic data are useful for fisheries assessment. Low summer flows, for example, affect the ability of fisheries personnel to conduct habitat and biological assessment activities. Winter and spring spawning surveys must be timed according to adult access flows. Scheduling for these surveys, as well as calibrating the survey results can be facilitated by reviewing hydrographic data.

CALIFORNIA SALMONID STREAM HABITAT RESTORATION MANUAL

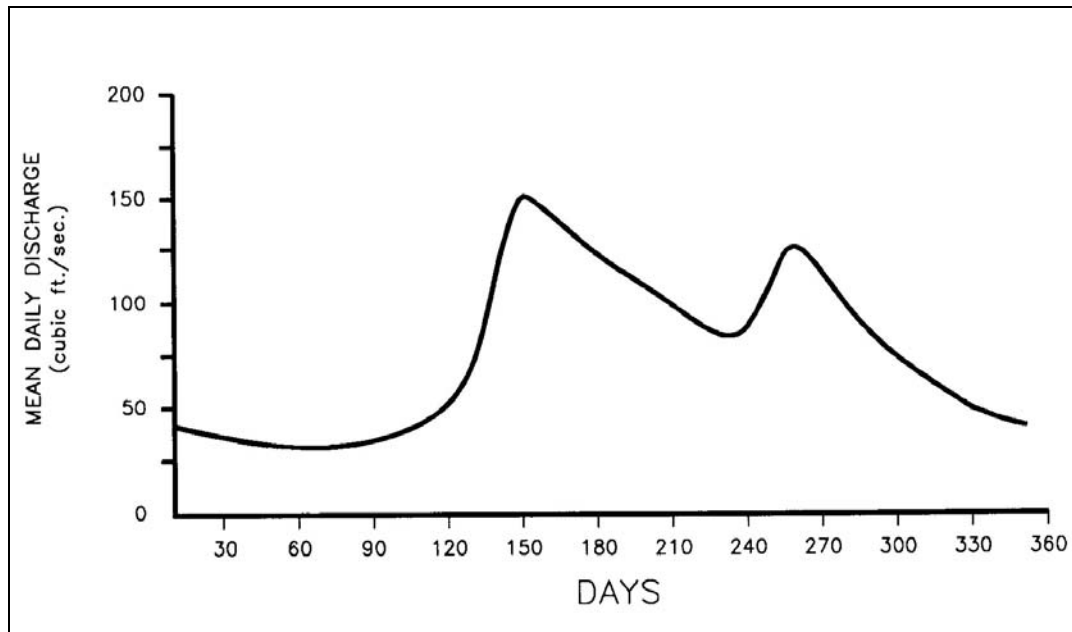

Figure II-4. Hydrograph.

For streams without a gauging station a hydrograph can be constructed by relating the un-gauged stream to a nearby gauged stream of similar drainage area, aspect, and rainfall. If the information is used for comparison with a gauged stream, flow in the un-gauged stream is assumed to vary in a manner similar to the gauged stream. For most purposes a simple transformation of the data can be made by applying a correction factor. For example, if the discharge of the gauged stream (stream A) is measured at 100, 80 and 60 cfs on different days, and the discharge on the un-gauged stream (stream B) is 120, 96, and 72 cfs on those same days, the correction factor (ratio of flow in stream B to stream A) would be 1.2 (i.e., to estimate the discharge on stream B on any day, multiply the discharge of stream A on that day by 1.2). It is preferable to develop correction factors for several different ranges of flow.

Another way of comparing the stream discharges and extrapolating the discharge of the un-gauged stream is to express the discharge per unit area. For example, the drainage area of stream A is 200 square miles and of stream B is 215 square miles (Part II, "Watershed Overview Work Sheet Data Entry Instructions" for a description of how to calculate drainage area). Stream A would have discharges of $100/200=0.50$ cfs/sq. mi., $80/200=0.40$ cfs/sq. mi., and $60/200=0.30$ cfs/sq. mi. At the discharges stated, stream B would have discharges of $120/215=0.56$ cfs/sq. mi., $96/215=0.45$ cfs/sq. mi., and $72/215=0.33$ cfs/sq. mi. The correction factors would be $0.56/0.50=1.12$, $0.45/0.40=1.13$, and $0.33/0.30=1.10$. The average correction factor would be $(1.12+1.13+1.10)/3=1.12$.

This method of extrapolating discharge per unit area is suitable for high flows, but under low-flow situations it is less useful because the numbers get very small for most streams. For low-flow situations a simple extrapolation on flow may be more useful.

CALIFORNIA SALMONID STREAM HABITAT RESTORATION MANUAL

By applying the correction factor to prior years' data it is possible to compute the discharges in un-gauged streams and construct annual hydrographs for the selected years. Armed with these hydrographs, the habitat restoration planner can roughly estimate future flows.

The correlation between two streams is seldom very close or reliable in any single year and reliance on a correction factor should be undertaken with caution.

CALIFORNIA SALMONID STREAM HABITAT RESTORATION MANUAL

REFERENCES

- California State Water Resources Control Board. 1990. Information Pertaining to Water Rights in California. 20 p.
- Lamberti, Gary A., and Stan V. Gregory. 1989. The importance of riparian zones to stream ecosystems. Proceedings of the Seventh California Salmon, Steelhead and Trout Restoration Conference. Eureka, CA.
- Leopold, L.B., M.G. Wolman, and J.P. Miller. 1964. Fluvial processes in geomorphology, W.H. Freeman, San Francisco. 522 p.
- Morisawa, M.E. 1966. Streams, their dynamics and morphology, McGraw-Hill, 175 p.
- Moyle, P.B., R.M. Yoshiyama, J.E. Williams, and E.D. Wikramanayake. 1995. Fish species of special concern. Calif. Dept. of Fish and Game, Sacramento. 272 pp.
- Nielsen, L.A. and D.L. Johnson. 1983. Fisheries techniques. American Fisheries Society, Bethesda, Maryland.
- Orsborn, J.F. 1986. Hydrology and hydraulics for biologists, a workshop sponsored by the California-Nevada Chapter of the American Fisheries Society, Eureka, CA.
- Strahler, A.N. 1957. Qualitative analysis of watershed geomorphology. Transactions American Geophysical Union 38:913-920.
- U.S. Department of Agriculture, Forest Service. February 1990. Fish Habitat Assessment Handbook, USFS, Region 5, FSH 2609.23, Draft Copy.

CALIFORNIA SALMONID STREAM HABITAT RESTORATION MANUAL

PART III

HABITAT INVENTORY METHODS



CALIFORNIA SALMONID STREAM HABITAT RESTORATION MANUAL

PART III HABITAT INVENTORY METHODS

Following completion of a preliminary watershed overview, a stream habitat inventory should be conducted. The preferred procedures used to accomplish fish habitat inventory include: 1) stream channel typing using the stream classification system developed by D. L. Rosgen (1994); and 2) habitat typing using a variation of the system originally developed by P. A. Bisson, et al. (1982) and later expanded by others. Stream channel typing describes relatively long reaches within a stream using eight morphological characteristics. Habitat typing describes the specific pool, flatwater, and riffle habitats within a stream.

The different habitat types and their boundaries are easily identified once the surveyor gains experience. Changes in stream channel types are more subtle and require a surveyor to recognize changes in substrate, channel entrenchment, gradient, and other morphological characteristics that signal a different channel type.

The field data collected is used for stream analysis and planning. DFG has developed a data entry and summary program to process the field data (Part V). An examination of the results will provide the baseline data necessary to determine if habitat modification may be appropriate. If habitat projects are implemented, baseline data are vital for evaluation and monitoring.

Before deciding whether or not to modify fish habitat in a stream reach, judgements can be made as to the need and range of suitable structures applicable to the stream channel type. Rosgen and Fittante (1986), and Rosgen (1994) developed guidelines for evaluating the suitability of a wide variety of commonly used habitat enhancement designs over a wide range of channel types. (Pages III-8 through III-21, Stream Channel Type Descriptions and Structure Suitability).

HABITAT INVENTORY FIELD PREPARATION

All habitat inventory field work must be conducted by two persons. Wading shoes with non-slip soles are recommended. If hip boots, chest waders, or hiking boots are used, non-slip soles or non-slip cleats must be worn.

Permission to trespass must be obtained before field work begins on private land (Appendix N). The designated agency manager of public land should always be notified before inventory work begins on public land.

Most surveyors use a day pack or a vest to carry their tools and supplies, a coat or rain gear, food, and water. Do not drink any stream water that has not been purified and treated to destroy *Giardia*.

CALIFORNIA SALMONID STREAM HABITAT RESTORATION MANUAL

Tools and Supplies Needed for Two Person Crew

- Stream Channel Typing Work Sheet and Habitat Inventory Data Forms
- Pencil(s) and waterproof marker(s)
- Plastic flagging
- Topographic maps (it is best to carry photocopies)
- Camera (film)
- Thermometer
- Watch
- Stadia rod (fiberglass, calibrated in tenths)
- Fiberglass open reel tape 200 ft.
- Optical range finder (optional)
- Hand level
- Flow meter
- Compass
- Hip chain and thread
- Spherical densiometer
- Aluminum clipboard and waterproof notebook
- First aid kit
- Aluminum nails and tags (for marking reference points)
- Cruiser's vest or day pack
- Footwear with non-slip soles

STREAM CLASSIFICATION SYSTEM

This manual uses a modified stream classification system developed by Rosgen (1994). Stream types are characterized by eight morphological features:

- | | |
|------------------|-----------------------------------|
| 1) Channel width | 5) Channel slope |
| 2) Depth | 6) Roughness of channel materials |
| 3) Velocity | 7) Sediment load |
| 4) Discharge | 8) Sediment size |

Some applications of stream classification data include:

- Determine the suitability of habitat restoration structures.
- Describe specific stream reaches by channel type and sequence within the basin.
- Predict a stream's behavior from its appearance.
- Describe the condition of the stream and its ability to transport the sediment yield from the watershed.
- Provide a consistent and reproducible frame of reference for communication among those working with river systems.

CALIFORNIA SALMONID STREAM HABITAT RESTORATION MANUAL

Stream Channel Type Definitions

The following terminology is provided to gain an understanding of the measurable information needed to classify stream types.

Channel type unit length: A stream reach must exhibit the same channel type over a minimum distance of twenty bankfull channel widths to be recognized as an independent stream channel type unit.

Bankfull discharge (Q_{bkf}): The dominant channel forming flow, and has a recurrence interval of 1.5 years.

Bankfull depth (d_{bkf}): The mean depth measured at bankfull discharge.

Bankfull width (W_{bkf}): The channel width at bankfull discharge. This stage is delineated by the presence of a floodplain at the elevation of incipient flooding and indicated by deposits of fine sediments such as sand or silt at the active scour mark, break in stream bank slope, and/or perennial vegetation limit (Figure III-1).

Flood-prone area: Any flat, or nearly flat lowland that borders a stream and is covered by its waters at flood stage (Figure III-1). This is determined at twice the maximum bankfull depth.

Flood-prone width (W_{FP}): The stream width at a discharge level defined as twice the maximum bankfull depth.

Wetted width: The width of the wetted stream at the time of the survey. Wetted width is generally less than bankfull width. Wetted width is also referred to as "low flow channel".

Stream Type Delineation Criteria

The Rosgen delineation criteria includes general description, width/depth ratio, water surface slope/gradient, dominant particle size, entrenchment and sinuosity.

General description: A general description of the channel geometry, gradient, bank stability, substrate, pool or riffle occurrence, etc.

CALIFORNIA SALMONID STREAM HABITAT RESTORATION MANUAL

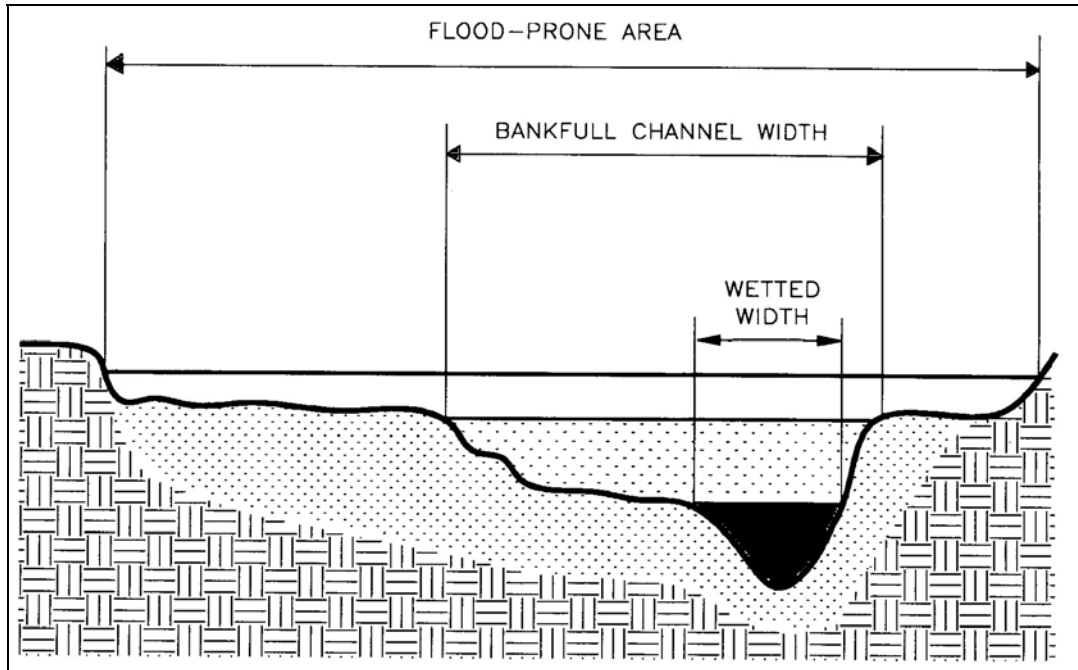

Figure III-1. Channel cross section.

Width/depth ratio: The ratio of the bankfull width (W_{bkf}) to the bankfull mean depth (d_{bkf}). The categories are:

- 1) Low ($W_{bkf}/d_{bkf} < 12$)
- 2) Moderate to High (W_{bkf}/d_{bkf} 12 - 40)
- 3) Very High ($W_{bkf}/d_{bkf} > 40$)

Water surface slope/gradient: The slope of the water surface is measured over a distance of at least 20 bankfull channel widths at velocity crossovers.

Dominant substrate: The most common particle found on the bed of the stream measured at the velocity crossover. The particles are classified by their maximum diameter.

PARTICLE SIZE:	INCHES
Boulder	> 10"
Cobble	2.5-10"
Gravel	0.08-2.5"
Sand	< 0.08"
Silt/clay	N/A
Bedrock	N/A

CALIFORNIA SALMONID STREAM HABITAT RESTORATION MANUAL

Entrenchment: The ratio between flood-prone width (W_{FP}) and bankfull width (W_{bkf}). There are three categories (Figure III-2):

- 1) Entrenched ($W_{FP}/W_{bkf} < 1.4$)
- 2) Moderately entrenched (W_{FP}/W_{bkf} 1.4 to 2.2)
- 3) Slightly entrenched ($W_{FP}/W_{bkf} > 2.2$)

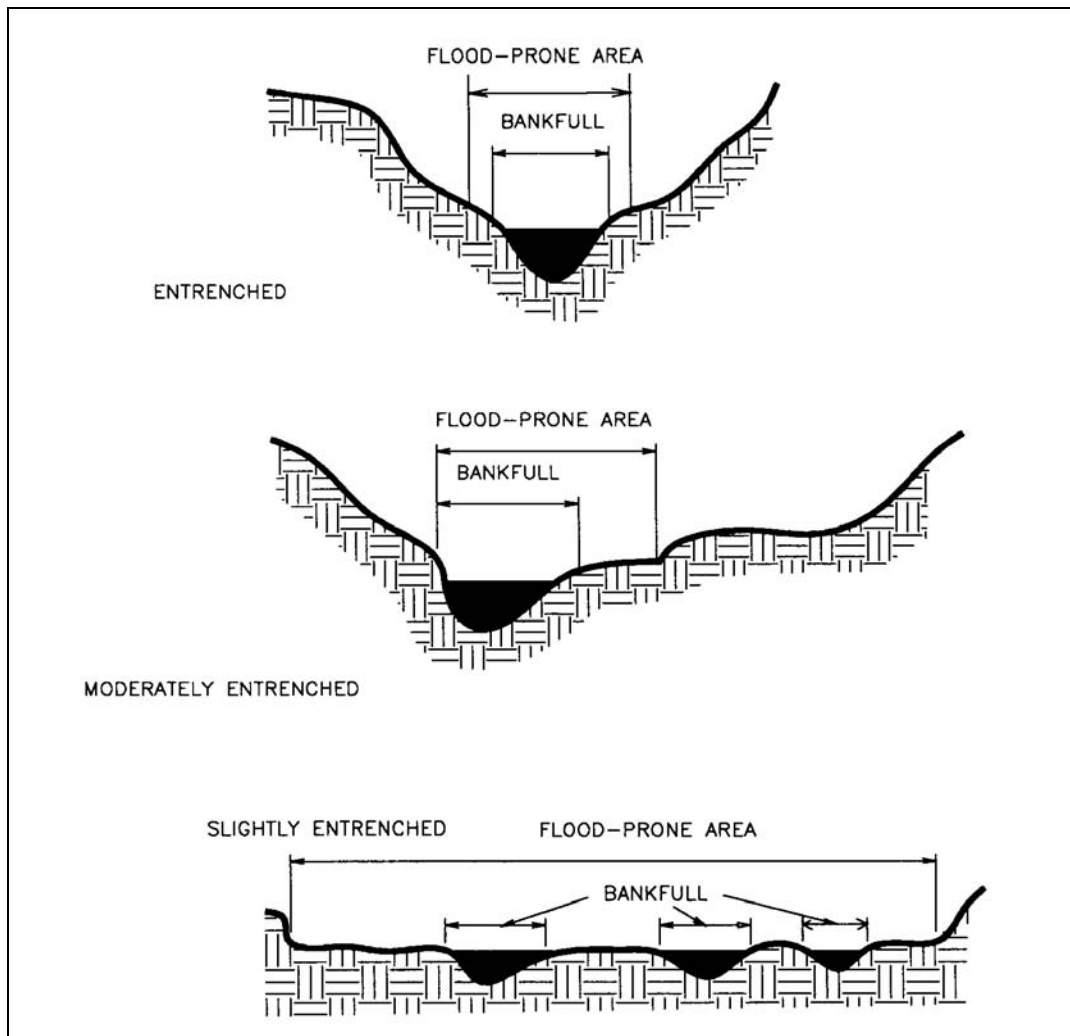

Figure III-2. Entrenchment.

CALIFORNIA SALMONID STREAM HABITAT RESTORATION MANUAL

Sinuosity: The ratio between stream length and valley length (Figure III-3).

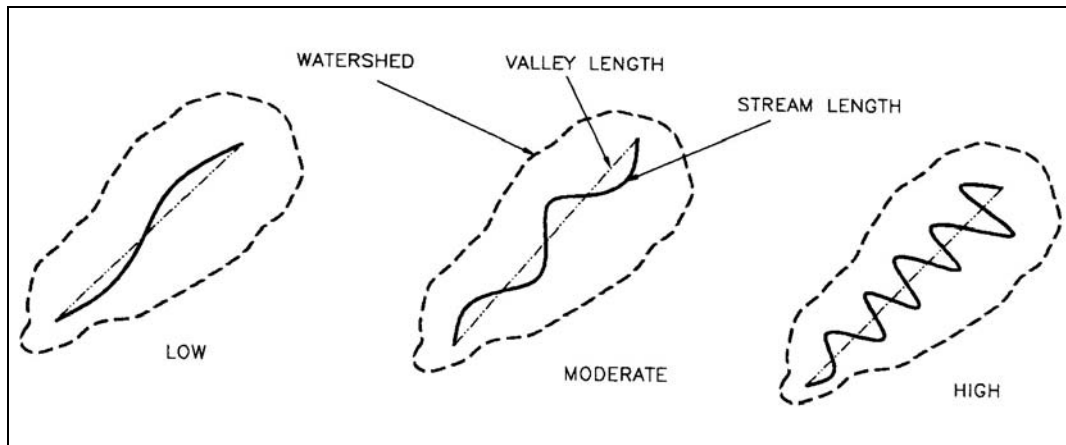

Figure III-3. Sinuosity.

The following picture depicts a generalized spatial relationship of different stream types as described by Rosgen (1994). Typically “A” type stream channels are located in the highly confined steep gradient reaches (4 percent or greater). As you move downstream and confinement and gradient decrease, stream channels typically grade to “B” and then “C” stream channel categories until reaching areas of no confinement, typically “D” type stream channels (Figure III-4). However, stream order and physiographic position within the drainage do not necessarily indicate stream type. For example, a “D” stream type may occur in the headwaters of a particular stream as an alluvial fan downstream of a glacial outfall.

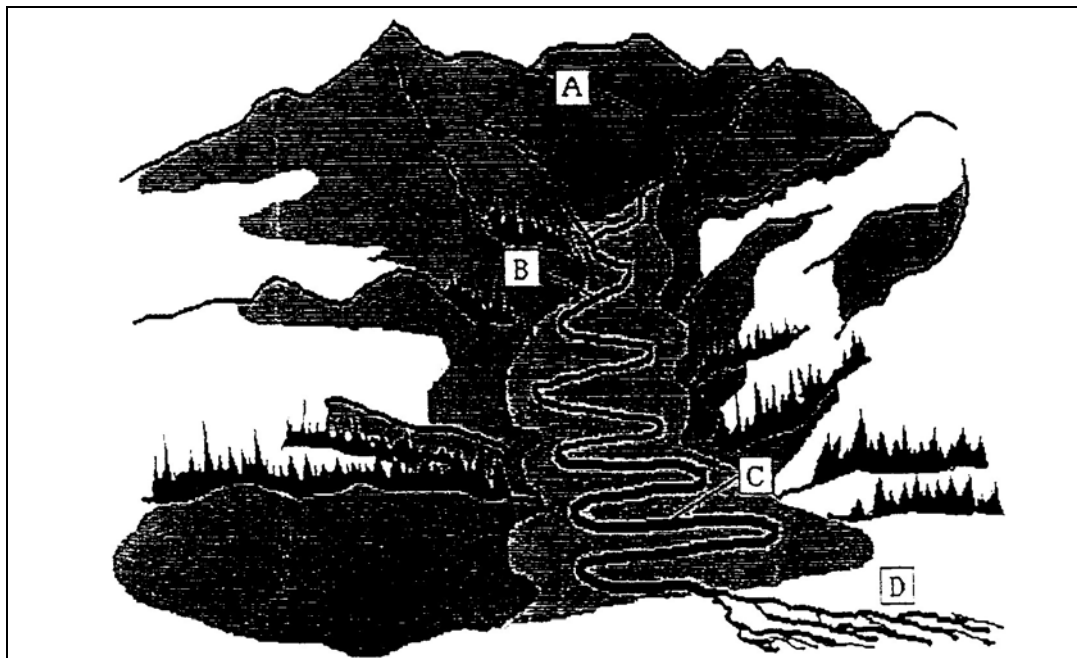

Figure III-4. Relationship of different stream types.

**CALIFORNIA SALMONID STREAM
HABITAT RESTORATION MANUAL**

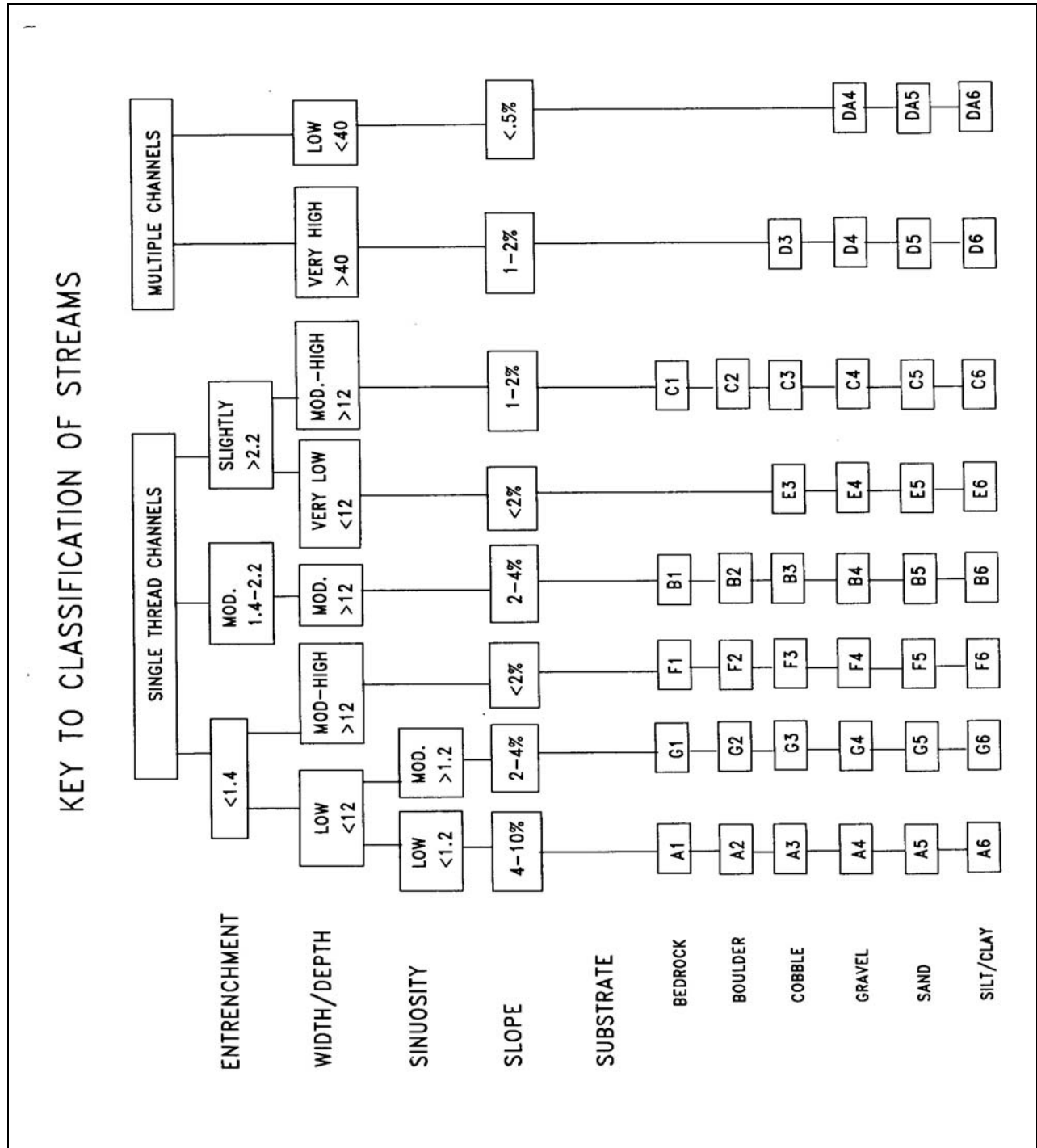

Figure III-5. Key to classification of streams.

CALIFORNIA SALMONID STREAM HABITAT RESTORATION MANUAL

STREAM CHANNEL TYPE DESCRIPTIONS AND STRUCTURE SUITABILITY

Water surface slope/gradient, entrenchment, width/depth ratio, and dominant substrate are all determined from measurements taken in the field. Sinuosity can be estimated from a 7.5-minute topographic map by measuring the lengths of the valley and the stream. Each measurement will be discussed in Part III, "Instructions for Completing the Stream Channel Type Work Sheet." After the measurements are taken the channel type can be determined using the key to classification of streams (Figure III-5).

Delineation criteria represent averages from a population of measurements characteristic to a wide variety of stream channels. Deviations of measured values from these average values occur in nature, and represent variability within the range of typical values, as well as variability from region to region. Rosgen (1996) notes that values for entrenchment and sinuosity can vary by + 0.2 units, while width-depth ratios can vary by + 2.0 units without necessarily dictating a change in channel type.

Descriptions of stream channel types, as developed by Rosgen (1994), are presented below as well as lists of habitat improvement structures suitable for use or consideration in each stream channel type (Part VI- Instream Structure Suitability By Stream Type).

Stream Channel Types

A1 General Description: Steep, narrow, cascading, step-pool streams; high energy/debris transport associated with depositional soils; very stable bedrock channel.

Entrenchment: Entrenched < 1.4

Water Surface Slope/Gradient: 4-10%

Dominant Substrate Particle Size: Predominantly bedrock.

Width/Depth Ratio: < 12

Sinuosity: < 1.2

Fish Habitat Improvement Structure Suitability: Generally not suitable. High energy streams with stable stream banks, and poor gravel retention capabilities.

A2 General Description: Steep, narrow, cascading, step-pool streams; high energy/debris transport associated with depositional soils; boulder channel.

Entrenchment: Entrenched < 1.4

Water Surface Slope/Gradient: 4-10%

Dominant Substrate: Predominantly boulders.

Width/Depth Ratio: < 12

Sinuosity: < 1.2

Fish Habitat Improvement Structure Suitability: Generally not suitable. High energy streams with stable stream banks, and poor gravel retention capabilities.

CALIFORNIA SALMONID STREAM HABITAT RESTORATION MANUAL

A3 **General Description:** Steep, narrow, cascading, step-pool streams; high energy/debris transport associated with depositional soils; cobble channel.

Entrenchment: Entrenched < 1.4

Water Surface Slope/Gradient: 4-10%

Dominant Substrate: Predominantly cobble.

Width/Depth Ratio: < 12

Sinuosity: < 1.2

Fish Habitat Improvement Structure Suitability:

- Good for bank-placed boulders.
- Fair for plunge weirs; opposing wing-deflectors; and log cover.
- Poor for boulder clusters and single wing-deflectors.

A4 **General Description:** Steep, narrow, cascading, step-pool streams; high energy/debris transport associated with depositional soils; gravel channel.

Entrenchment: Entrenched < 1.4

Water Surface Slope/Gradient: 4-10%

Dominant Substrate: Predominantly gravel.

Width/Depth Ratio: < 12

Sinuosity: < 1.2

Fish Habitat Improvement Structure Suitability:

- Good for bank-placed boulders.
- Fair for plunge weirs; opposing wing-deflectors; and log cover.
- Poor for boulder clusters and single wing-deflectors.

A5 **General Description:** Steep, narrow, cascading, step-pool streams; high energy/debris transport associated with depositional soils; sand channel.

Entrenchment: Entrenched < 1.4

Water Surface Slope/Gradient: 4-10%

Dominant Substrate: Predominantly sand.

Width/Depth Ratio: < 12

Sinuosity: < 1.2

Fish Habitat Improvement Structure Suitability:

- Good for bank-placed boulders.
- Fair for plunge weirs; opposing wing-deflectors; and log cover.
- Poor for boulder clusters and single wing-deflectors.

**CALIFORNIA SALMONID STREAM
HABITAT RESTORATION MANUAL**

A6 **General Description:** Steep, narrow, cascading, step-pool streams; high energy/debris transport associated with depositional soils; silt/clay channel.

Entrenchment: Entrenched < 1.4

Water Surface Slope/Gradient: 4-10%

Dominant Substrate: Predominantly silt/clay.

Width/Depth Ratio: < 12

Sinuosity: < 1.2

Fish Habitat Improvement Structure Suitability:

- Good for bank-placed boulders.
- Fair for plunge weirs, opposing wing-deflectors, and log cover.
- Poor for boulder clusters; single wing-deflectors.

B1 **General Description:** Moderately entrenched, moderate gradient, riffle dominated channel with infrequently spaced pools; very stable plan and profile; stable banks; bedrock channel.

Entrenchment: Moderately entrenched 1.4 - 2.2

Water Surface Slope/Gradient: 2-4%

Dominant Substrate: Predominantly bedrock.

Width/Depth Ratio: > 12

Sinuosity: > 1.2

Fish Habitat Improvement Structure Suitability:

- Excellent for bank-placed boulders.
- Good for log cover.
- Poor for plunge weirs; single and opposing wing-deflectors; boulder clusters.

B2 **General Description:** Moderately entrenched, moderate gradient, riffle dominated channel with infrequently spaced pools; very stable plan and profile; stable banks; boulder channel.

Entrenchment: Moderately entrenched 1.4 - 2.2

Water Surface Slope/Gradient: 2-4%

Dominant Substrate: Predominantly boulders.

Width/Depth Ratio: > 12

Sinuosity: > 1.2

Fish Habitat Improvement Structure Suitability:

- Excellent for plunge weirs; single and opposing wing-deflectors; log cover.

CALIFORNIA SALMONID STREAM HABITAT RESTORATION MANUAL

B3 **General Description:** Moderately entrenched, moderate gradient, riffle dominated channel with infrequently spaced pools; very stable plan and profile; stable banks; cobble channel.

Entrenchment: Moderately entrenched 1.4 - 2.2

Water Surface Slope/Gradient: 2-4%

Dominant Substrate: Predominantly cobble.

Width/Depth Ratio: > 12

Sinuosity: > 1.2

Fish Habitat Improvement Structure Suitability:

- Excellent for plunge weirs; boulder clusters and bank placed boulder; single and opposing wing-deflectors; log cover.

B4 **General Description:** Moderately entrenched, moderate gradient, riffle dominated channel with infrequently spaced pools; very stable plan and profile; stable banks; gravel channel.

Entrenchment: Moderately entrenched 1.4 - 2.2

Water Surface Slope/Gradient: 2-4%

Dominant Substrate: Predominantly gravel.

Width/Depth Ratio: > 12

Sinuosity: > 1.2

Fish Habitat Improvement Structure Suitability:

- Excellent for low-stage plunge weirs; boulder clusters; bank placed boulders; single and opposing wing-deflectors; log cover.

B5 **General Description:** Moderately entrenched, moderate gradient, riffle dominated channel with infrequently spaced pools; very stable plan and profile; stable banks; sand channel.

Entrenchment: Moderately entrenched 1.4 - 2.2

Water Surface Slope/Gradient: 2-4%

Dominant Substrate: Predominantly sand.

Width/Depth Ratio: > 12

Sinuosity: > 1.2

Fish Habitat Improvement Structure Suitability:

- Excellent for bank-placed boulders.
- Good for low-stage weir; single and opposing wing-deflectors; channel constrictors; log cover.

CALIFORNIA SALMONID STREAM HABITAT RESTORATION MANUAL

B6 **General Description:** Moderately entrenched, moderate gradient, riffle dominated channel with infrequently spaced pools; very stable plan and profile; stable banks; silt/clay channel.

Entrenchment: Moderately entrenched 1.4 - 2.2

Water Surface Slope/Gradient: 2-4%

Dominant Substrate: Predominantly silt/clay.

Width/Depth Ratio: > 12

Sinuosity: > 1.2

Fish Habitat Improvement Structure Suitability:

- Excellent for bank-placed boulders; log cover.
- Good for plunge weirs; single and opposing wing-deflectors; channel constrictors.
- Fair for boulder clusters.

C1 **General Description:** Low gradient, meandering, point-bar, riffle/pool, alluvial channels with broad, well defined floodplain; bedrock channel.

Entrenchment: Slightly entrenched > 2.2

Water Surface Slope/Gradient: < 2%

Dominant Substrate: Predominantly bedrock.

Width/Depth Ratio: > 12

Sinuosity: > 1.4

Fish Habitat Improvement Structure Suitability:

- Excellent for bank-placed boulders; and log cover.
- Poor for plunge weirs; boulder clusters; single and opposing wing-deflectors.

C2 **General Description:** Low gradient, meandering, point-bar, riffle/pool, alluvial channels with broad, well defined floodplain; boulder channel.

Entrenchment: Slightly entrenched > 2.2

Water Surface Slope/Gradient: < 2%

Dominant Substrate: Predominantly boulder.

Width/Depth Ratio: > 12

Sinuosity: > 1.4

Fish Habitat Improvement Structure Suitability:

- Good for plunge weirs; single and opposing wing-deflectors; channel constrictors; log cover.

**CALIFORNIA SALMONID STREAM
HABITAT RESTORATION MANUAL**

C3 **General Description:** Low gradient, meandering, point-bar, riffle/pool, alluvial channels with broad, well defined floodplain; cobble channel.
Entrenchment: Slightly entrenched > 2.2
Water Surface Slope/Gradient: < 2%
Dominant Substrate: Predominantly cobble.
Width/Depth Ratio: > 12
Sinuosity: > 1.4

Fish Habitat Improvement Structure Suitability:

- Excellent for bank-placed boulders.
- Good for plunge weirs; boulder clusters; single and opposing wing deflectors; log cover.

C4 **General Description:** Low gradient, meandering, point-bar, riffle/pool, alluvial channels with broad, well defined floodplain; gravel channel.
Entrenchment: Slightly entrenched > 2.2
Water Surface Slope/Gradient: < 2%
Dominant Substrate: Predominantly gravel.
Width/Depth Ratio: > 12
Sinuosity: > 1.4

Fish Habitat Improvement Structure Suitability:

- Good for bank-placed boulders.
- Fair for plunge weirs; single and opposing wing-deflectors; channel constrictors; log cover.

C5 **General Description:** Low gradient, meandering, point-bar, riffle/pool, alluvial channels with broad, well defined floodplain; sand channel.
Entrenchment: Slightly entrenched > 2.2
Water Surface Slope/Gradient: < 2%
Dominant Substrate: Predominantly sand.
Width/Depth Ratio: > 12
Sinuosity: > 1.4

Fish Habitat Improvement Structure Suitability:

- Good for bank-placed boulders.
- Fair for plunge weirs; log cover.
- Poor for boulder clusters; single and opposing wing deflectors.

**CALIFORNIA SALMONID STREAM
HABITAT RESTORATION MANUAL**

C6 **General Description:** Low gradient, meandering, point-bar, riffle/pool, alluvial channels with broad, well defined floodplain; silt/clay channel.
Entrenchment: Slightly entrenched > 2.2
Water Surface Slope/Gradient: < 2%
Dominant Substrate: Predominantly silt/clay.
Width/Depth Ratio: > 12
Sinuosity: > 1.4

Fish Habitat Improvement Structure Suitability:

- Good for bank-placed boulders; log cover.
- Fair for plunge weir.
- Poor for boulder clusters; single wing-deflectors and opposing wing-deflectors.

D3 **General Description:** Multiple channels with longitudinal and transverse bars; very wide channel with eroding banks; cobble channel.
Entrenchment: No entrenchment.
Water Surface Slope/Gradient: < 2%
Dominant Substrate: Predominantly cobble.
Width/Depth Ratio: > 40
Sinuosity: < 1.1

Fish Habitat Improvement Structure Suitability:

- Fair for bank-placed boulders; single and opposing wing-deflectors; channel constrictors.
- Poor for plunge weirs; boulder clusters; log cover.

D4 **General Description:** Multiple channels with longitudinal and transverse bars; very wide channel with eroding banks; gravel channel.
Entrenchment: No entrenchment.
Water Surface Slope/Gradient: < 2%
Dominant Substrate: Predominantly gravel.
Width/Depth Ratio: > 40
Sinuosity: < 1.1

Fish Habitat Improvement Structure Suitability:

- Fair for bank-placed boulders; single and opposing wing-deflectors; channel constrictors.
- Poor for plunge weirs; boulder clusters; log cover.

**CALIFORNIA SALMONID STREAM
HABITAT RESTORATION MANUAL**

D5 **General Description:** Multiple channels with longitudinal and transverse bars; very wide channel with eroding banks; sand channel.
Entrenchment: No entrenchment.
Water Surface Slope/Gradient: < 2%
Dominant Substrate: Predominantly sand.
Width/Depth Ratio: > 40
Sinuosity: < 1.1

Fish Habitat Improvement Structure Suitability:

- Fair for bank-placed boulders; single and opposing wing-deflectors; channel constrictors.
- Poor for plunge weirs; boulder clusters; log cover.

D6 **General Description:** Braided channel with longitudinal and transverse bars; very wide channel with eroding banks; silt/clay channel.
Entrenchment: No entrenchment.
Water Surface Slope/Gradient: < 2%
Dominant Substrate: Predominantly silt/clay.
Width/Depth Ratio: > 40
Sinuosity: < 1.1

Fish Habitat Improvement Structure Suitability:

- Fair for bank-placed boulders; single and opposing wing-deflectors; channel constrictors.
- Poor for plunge weirs; boulder clusters; log cover.

DA4 **General Description:** Multiple channels, narrow and deep with expansive well vegetated floodplain and associated wetlands; very gentle relief with highly variable sinuosities; stable stream banks; gravel channel.
Entrenchment: Low to zero entrenchment > 2.2
Water Surface Slope/Gradient: < 0.5%
Dominant Substrate: Predominantly gravel.
Width/Depth Ratio: < 40
Sinuosity: 1.1 - 1.6

Fish Habitat Improvement Structure Suitability: Generally not suitable.

CALIFORNIA SALMONID STREAM HABITAT RESTORATION MANUAL

DA5 General Description: Multiple channels, narrow and deep with expansive well vegetated floodplain and associated wetlands; very gentle relief with highly variable sinuosities; stable stream banks; sand channel.

Entrenchment: Low to zero entrenchment > 2.2

Water Surface Slope/Gradient: < 0.5%

Dominant Substrate: Predominantly sand.

Width/Depth Ratio: < 40

Sinuosity: 1.1 - 1.6

Fish Habitat Improvement Structure Suitability: Generally not suitable.

DA6 General Description: Multiple channels, narrow and deep with expansive well vegetated floodplain and associated wetlands; very gentle relief with highly variable sinuosities; stable stream banks; silt/clay channel.

Entrenchment: Low to zero entrenchment > 2.2

Water Surface Slope/Gradient: < 0.5%

Dominant Substrate: Predominantly silt/clay.

Width/Depth Ratio: < 40

Sinuosity: 1.1 - 1.6

Fish Habitat Improvement Structure Suitability: Generally not suitable.

E3 General Description: Low gradient, meandering riffle/pool stream with low width/depth ratio and little deposition; very efficient and stable; high meander width ratio; cobble channel.

Entrenchment: Slight entrenchment > 2.2

Water Surface Slope/Gradient: < 2%

Dominant Substrate: Predominantly cobbles.

Width/Depth Ratio: < 12

Sinuosity: > 1.5

Fish Habitat Improvement Structure Suitability:

- Good for bank-placed boulders.
- Fair for opposing wing-deflectors.
- Poor for plunge weirs; boulder clusters; single wing-deflectors.

CALIFORNIA SALMONID STREAM HABITAT RESTORATION MANUAL

E4 **General Description:** Low gradient, meandering riffle/pool stream with low width/depth ratio and little deposition; very efficient and stable; high meander width ratio; gravel channel.

Entrenchment: Slight entrenchment > 2.2

Water Surface Slope/Gradient: < 2%

Dominant Substrate: Predominantly gravel.

Width/Depth Ratio: < 12

Sinuosity: > 1.5

Fish Habitat Improvement Structure Suitability:

- Good for bank-placed boulders.
- Fair for opposing wing-deflectors.
- Poor for plunge weirs; boulder clusters; single wing-deflectors.

E5 **General Description:** Low gradient, meandering riffle/pool stream with low width/depth ratio and little deposition; very efficient and stable; high meander width ratio; sand channel.

Entrenchment: Slight entrenchment > 2.2

Water Surface Slope/Gradient: < 2%

Dominant Substrate: Predominantly sand.

Width/Depth Ratio: < 12

Sinuosity: > 1.5

Fish Habitat Improvement Structure Suitability:

- Good for bank-placed boulders.
- Fair for opposing wing-deflectors.
- Poor for plunge weirs; boulder clusters; single wing-deflectors.

E6 **General Description:** Low gradient, meandering riffle/pool stream with low width/depth ratio and little deposition; very efficient and stable; high meander width ratio; silt/clay channel.

Entrenchment: Slight entrenchment > 2.2

Water Surface Slope/Gradient: < 2%

Dominant Substrate: Predominantly silt/clay.

Width/Depth Ratio: < 12

Sinuosity: > 1.5

Fish Habitat Improvement Structure Suitability:

- Good for bank-placed boulders.
- Fair for opposing wing-deflectors.
- Poor for plunge weirs; boulder clusters; single wing-deflectors.

CALIFORNIA SALMONID STREAM HABITAT RESTORATION MANUAL

F1 **General Description:** Entrenched meandering riffle/pool channel on low gradients with high width/depth ratio; very stable if bedrock controlled channel.

Entrenchment: Well entrenched < 1.4

Water Surface Slope/Gradient: < 2%

Dominant Substrate: Predominantly bedrock.

Width/Depth Ratio: > 12

Sinuosity: > 1.4

Fish Habitat Improvement Structure Suitability:

- Good for bank-placed boulders.
- Fair for single wing-deflectors; log cover.
- Poor for plunge weirs; boulder clusters; opposing wing deflectors.

F2 **General Description:** Entrenched meandering riffle/pool channel on low gradients with high width/depth ratio; boulder channel.

Entrenchment: Well entrenched < 1.4

Water Surface Slope/Gradient: < 2%

Dominant Substrate: Predominantly boulders.

Width/Depth Ratio: > 12

Sinuosity: > 1.4

Fish Habitat Improvement Structure Suitability:

- Fair for plunge weirs; single and opposing wing-deflectors; log cover.

F3 **General Description:** Entrenched meandering riffle/pool channel on low gradients with high width/depth ratio; cobble channel.

Entrenchment: Well entrenched < 1.4

Water Surface Slope/Gradient: < 2%

Dominant Substrate: Predominantly cobble.

Width/Depth Ratio: > 12

Sinuosity: > 1.4

Fish Habitat Improvement Structures Suitability:

- Good for bank-placed boulders; single and opposing wing-deflectors.
- Fair for plunge weirs; boulder clusters; channel constrictors; log cover.

CALIFORNIA SALMONID STREAM HABITAT RESTORATION MANUAL

F4 **General Description:** Entrenched meandering riffle/pool channel on low gradients with high width/depth ratio; gravel channel.
Entrenchment: Well entrenched < 1.4
Water Surface Slope/Gradient: < 2%
Dominant Substrate: Predominantly gravel.
Width/Depth Ratio: > 12
Sinuosity: > 1.4

Fish Habitat Improvement Structures Suitability:

- Good for bank-placed boulders.
- Fair for plunge weirs; single and opposing wing-deflectors; channel constrictors; log cover.
- Poor for boulder clusters.

F5 **General Description:** Entrenched meandering riffle/pool channel on low gradients with high width/depth ratio; sand channel.
Entrenchment: Well entrenched < 1.4
Water Surface Slope/Gradient: < 2%
Dominant Substrate: Predominantly sand.
Width/Depth Ratio: > 12
Sinuosity: > 1.4

Fish Habitat Improvement Structure Suitability:

- Good for bank-placed boulders.
- Fair for plunge weirs; single and opposing wing-deflectors; channel constrictors; log cover.
- Poor for boulder clusters.

F6 **General Description:** Entrenched meandering riffle/pool channel on low gradients with high width/depth ratio; silt/clay channel.
Entrenchment: Well entrenched < 1.4
Water Surface Slope/Gradient: < 2%
Dominant Substrate: Predominantly silt/clay.
Width/Depth Ratio: > 12
Sinuosity: > 1.4

Fish Habitat Improvement Structure Suitability:

- Good for bank-placed boulders.
- Fair for plunge weirs; boulder clusters; single and opposing wing deflectors; log cover.

CALIFORNIA SALMONID STREAM HABITAT RESTORATION MANUAL

G1 **General Description:** Entrenched "gully" step-pool and low width/depth ratio on moderate gradient; stable if in a bedrock controlled channel.
Entrenchment: Well entrenched < 1.4
Water Surface Slope/Gradient: 2-4%
Dominant Substrate: Predominantly bedrock.
Width/Depth Ratio: < 12
Sinuosity: > 1.2

Fish Habitat Improvement Structure Suitability:

- Fair for log cover.
- Poor for boulder clusters.

G2 **General Description:** Entrenched "gully" step-pool and low width/depth ratio on moderate gradient.
Entrenchment: Well entrenched < 1.4
Water Surface Slope/Gradient: 2-4%
Dominant Substrate: Predominantly boulders.
Width/Depth Ratio: < 12
Sinuosity: > 1.2

Fish Habitat Improvement Structure Suitability:

- Fair for log cover.

G3 **General Description:** Entrenched "gully" step-pool and low width/depth ratio on moderate gradient.
Entrenchment: Well entrenched < 1.4
Water Surface Slope/Gradient: 2-4%
Dominant Substrate: Predominantly cobble.
Width/Depth Ratio: < 12
Sinuosity: > 1.2

Fish Habitat Improvement Structure Suitability:

- Good for bank-placed boulders.
- Fair for plunge weirs; opposing wing-deflectors; log cover.
- Poor for boulder clusters; single wing-deflectors.

CALIFORNIA SALMONID STREAM HABITAT RESTORATION MANUAL

G4 **General Description:** Entrenched "gully" step-pool and low width/depth ratio on moderate gradient.

Entrenchment: Well entrenched < 1.4

Water Surface Slope/Gradient: 2-4%

Dominant Substrate: Predominantly gravel.

Width/Depth Ratio: < 12

Sinuosity: > 1.2

Fish Habitat Improvement Structure Suitability:

- Good for bank-placed boulders.
- Fair for plunge weirs; opposing wing-deflectors; log cover.
- Poor for boulder clusters; single wing-deflectors.

G5 **General Description:** Entrenched "gully" step-pool and low width/depth ratio on moderate gradient.

Entrenchment: Well entrenched < 1.4

Water Surface Slope/Gradient: 2-4%

Dominant Substrate: Predominantly sand.

Width/Depth Ratio: < 12

Sinuosity: > 1.2

Fish Habitat Improvement Structure Suitability:

- Good for bank-placed boulders.
- Fair for plunge weirs; opposing wing-deflectors; log cover.
- Poor for boulder clusters; single wing-deflectors.

G6 **General Description:** Entrenched "gully" step-pool and low width/depth ratio on moderate gradient.

Entrenchment: Well entrenched < 1.4

Water Surface Slope/Gradient: 2-4%

Dominant Substrate: Predominantly silt/clay.

Width/Depth Ratio: < 12

Sinuosity: > 1.2

Fish Habitat Improvement Structure Suitability:

- Good for bank-placed boulders.
- Fair for plunge weirs; opposing wing-deflectors; log cover.
- Poor for boulder clusters; single wing-deflectors.

CALIFORNIA SALMONID STREAM HABITAT RESTORATION MANUAL

STREAM CHANNEL TYPE WORK SHEET

A Stream Channel Type Work Sheet is filled out at the beginning of the survey and each time the channel type changes. Significant changes in stream gradient, flood plain width, width/depth ratio, sinuosity or substrate size all indicate possible changes in channel type. The habitat unit number corresponding with the beginning and ending of each new channel type should be recorded on the Stream Channel Type Work Sheet and accompanying topographical field map. Field measurements for stream types are conducted at velocity crossover areas. Water surface slope measurements are taken between two points that are at least 20 bankfull channel widths apart. Velocity crossover areas occur where stream velocity changes from slower flatwater or pool velocities to the swifter riffle velocities. These crossover areas are typically found where the thalweg of the stream crosses from one side of the channel to the other (Figure III-6). Further, stream types should be determined at points where the channel geometry is not affected by outside influences. Outside influences include road embankments, riprap, landslides, tributaries, etc.

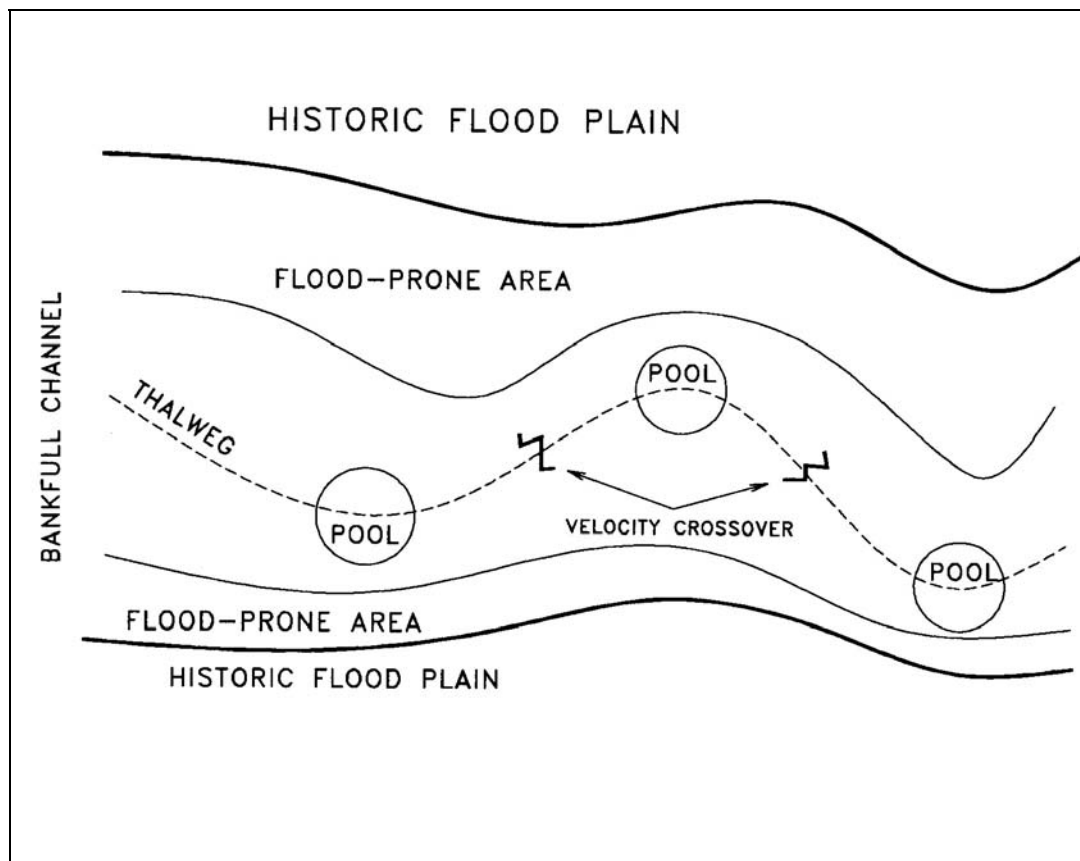

Figure III-6. Velocity crossover areas.

CALIFORNIA SALMONID STREAM HABITAT RESTORATION MANUAL

Instructions for Completing the Stream Channel Type Work Sheet

A channel type unit length must extend over a distance at least twenty times the average bankfull width.

- 1) **Form No.** - Print in the form number. Number the forms sequentially beginning with "01" on the first page, "02" on the second, and so on.
- 2) **Channel Type** - Enter the channel type code from the completed work sheet.
- 3) **Channel Change Location** - Enter the habitat unit # where the channel change occurred from the corresponding Habitat Inventory Data Form.
- 4) **Cross-Section Location** - Enter the habitat unit number at the location of the cross section.
- 5) **Date** - Enter the day's date: mm/dd/yy.
- 6) **Stream** - Print in the stream name.
- 7) **T-R-S** - Enter the township, range and section of the stream confluence. This information can be obtained from a USGS quadrangle.
- 8) **Surveyors** - Enter the names of the surveyors.
- 9) **Quad** - Enter the name(s) of the 7.5-minute USGS topographic map(s).
- 10) **Latitude** - Enter the stream's latitude in degrees, minutes, and seconds from the Watershed Overview Work Sheet. These positions can be obtained using a Global Positioning System (GPS) receiver, a GIS computer program, or a latitude and longitude calculator (Coordinator brand). (Appendix M).
- 11) **Longitude** - Enter the stream's longitude in degrees, minutes, and seconds from the Watershed Overview Work Sheet. These positions can be obtained using a Global Positioning System (GPS) receiver, a GIS computer program, or a latitude and longitude calculator (Coordinator brand). (Appendix M).
- 12) **Determination of Number of Channels** - Determine if the channel type reach is dominated by either a single thread or multiple channel(s) at bankfull discharge.
- 13) **Bankfull Width (W_{bkf})** - Measure the width of the stream at bankfull discharge (Q_{bkf}). Bankfull width is measured by stretching a level tape from one bank to the other, perpendicular to the stream and at the Q_{bkf} line of demarcation on each bank. Q_{bkf} is determined by changes in substrate composition, bank slope, and perennial vegetation caused by frequent scouring flows.

CALIFORNIA SALMONID STREAM HABITAT RESTORATION MANUAL

- 14) **Transect Recording Box** - This form is used to record depths and substrate composition from 20 stations equally spaced along a fiberglass measuring tape stretched across the channel at bankfull width. The distances at which measurements are made are recorded in the recording box=s top row titled "Dist." Measurements are taken along the tape line starting at zero at each predetermined distance point. Depths are the distance from the tape to the channel substrate below, and are recorded in the middle row titled "Depth." Twenty substrate samples are collected at the equidistant sample points along the distance of the tape by selecting the substrate particle first touched by the stadia rod. The code number for the corresponding substrate sampled is then recorded in the row titled "Sub."
- 15) **Dominant Substrate Determination** - When all 20 substrate samples have been collected, the number of samples of each substrate size are added and the totals are recorded in the summary section. The substrate most frequently sampled is the dominant substrate type.
- 16) **Entrenchment Determination** - (Figure III-7)

Step One: **Flood-Prone Width Elevation** - Multiply the deepest bankfull depth recorded in the Transect Recording Box by two.

Step Two: **Flood-Prone Width (W_{FP})** - Establish a level plane at an elevation twice the maximum bankfull depth and measure the distance between the points where the plane intersects the stream banks.

Step Three: **Entrenchment Determination** - Divide the flood prone width by the bankfull width to determine the entrenchment of the channel.

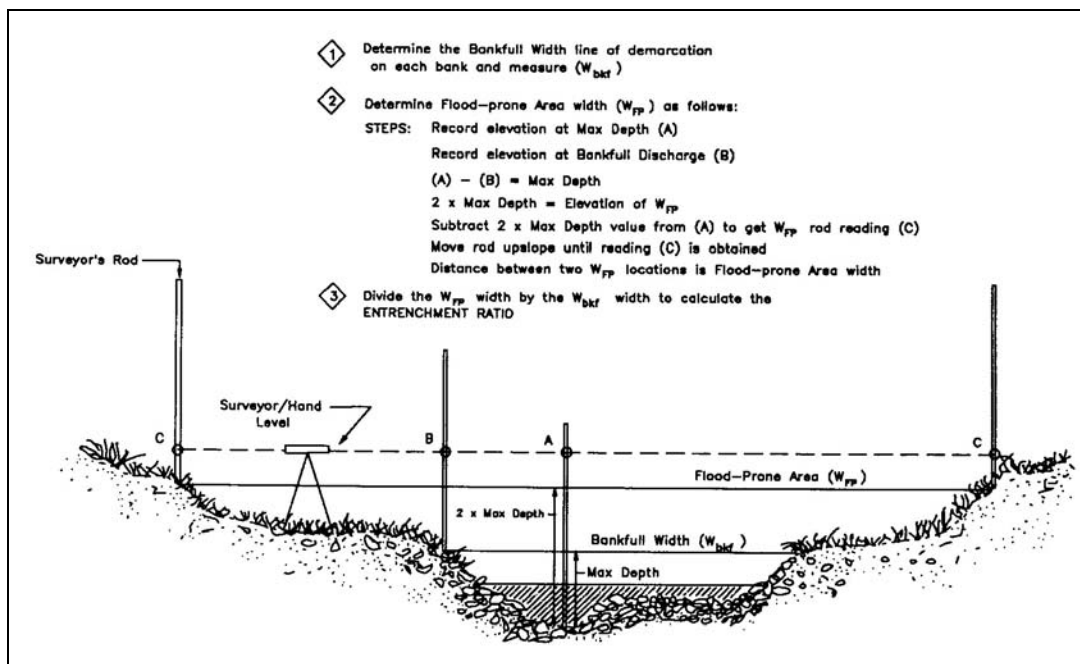

Figure III-7. Entrenchment determination.

CALIFORNIA SALMONID STREAM HABITAT RESTORATION MANUAL

17) **Width/Depth Determination -**

Step One: **Mean Bankfull Depth (d_{bkf})** - Divide the sum of depths from the transect recording box by the number of depths measured.

Step Two: **Width/Depth Determination** - Divide the bankfull width by mean bankfull depth to determine the width/depth ratio.

18) **Sinuosity** - Determine the ratio between stream length and valley length. These lengths can be calculated from 7.5-minute USGS topographic maps or aerial photographs using a map wheel. Sinuosity ratio is only used to distinguish A from G channel types.

19) **Water Surface Slope Determination** - To determine stream gradient, establish two survey stations along the stream at least twenty bankfull widths apart, and located at velocity crossover locations. Station elevations are set at the level of the water surface on either side of the stream. A sight level is used to determine the difference in elevation between the stadia rods. The horizontal distance between the stations is measured along the thalweg of the stream. The elevation difference is divided by the horizontal distance and multiplied by 100 to express water surface slope in percentile.

STREAM CHANNEL TYPE WORK SHEET

Form # ____ of ____

Channel Type _____ Channel Change Location (Habitat Unit#) _____
 Cross-Section Location (Habitat Unit#) _____ Date ____/____/____
 Stream _____
 T _____ R _____ S _____ Surveyors _____
 Quad _____ Lat _____ Long _____

Single Thread Channel _____ (Y/N) Multiple Channel _____ (Y/N)

Bankfull Width (W_{bkf}) = _____ (ft.)

Transect Recording Box

Dist.																				
Depth																				
Sub.																				

Sum of Depths _____

Dominant Substrate Determination:

- | | | | |
|----|----------------------|---------------|-----------------------------------|
| | <u>Substrate:</u> | <u>Number</u> | |
| 1. | Bedrock | = _____ | (Circle Most Frequent Occurrence) |
| 2. | Boulder (>10") | = _____ | |
| 3. | Cobble (2.5 - 10") | = _____ | |
| 4. | Gravel (0.08 - 2.5") | = _____ | |
| 5. | Sand (<0.08) | = _____ | |
| 6. | Silt / Clay | = _____ | |

Entrenchment Determination:

- Step 1: Maximum Bankfull Depth _____ x 2 = _____ (W_{FP} Elev.)
- Step 2: Determine Flood-Prone Width at WFP Elevation = _____ (W_{FP})
- Step 3: Flood-Prone Width (W_{FP}) / Bankfull Width (W_{bkf}) = Entrenchment
 W_{FP} _____ (ft.) / _____ (ft.) = _____ (**Entrenchment**)

Width/Depth Determination:

- Step 1: Sum of Depths _____ / No. Depths _____ = Mean Bankfull Depth (d_{bkf}) _____
- Step 2: Bankfull Width (W_{bkf}) / Mean Bankfull Depth (d_{bkf}) = Width/Depth Ratio
 W_{bkf} _____ (ft.) / d_{bkf} _____ (ft.) = _____ (**W/D Ratio**)

Sinuosity Determination (Only For A or G Types):

Stream Length _____ / Valley Length _____ = Sinuosity _____

Water surface slope Determination:

Downstream Level - Upstream Level _____ / Distance (D) = Energy Gradient
 DSL _____ (ft.) - USL _____ (ft.) / (D) _____ (ft.) = _____

CALIFORNIA SALMONID STREAM HABITAT RESTORATION MANUAL

HABITAT TYPING

The habitat typing procedure presented is a standardized methodology that physically describes 100 percent of the wetted channel. It is a composite of systems principally developed or modified by other investigators and compiled in part by Trinity Fisheries Consulting on contract to DFG.

Habitat types are described according to location, orientation, and water flow. The attributes distinguishing the various habitat types include over-all channel gradient, velocity, depth, substrate, and the channel features responsible for the unit's formation.

A basin-level habitat inventory is designed to produce a thorough description of the physical fish habitat. Basin-level habitat classification is on the scale of a stream's naturally occurring pool-riffle-run units. The length of a habitat unit depends on stream size and order. For basin-level habitat inventory, homogeneous areas of habitat that are equal or greater in length than one wetted channel width are recognized as distinct habitat units. During basin-level habitat typing, full sampling of each habitat unit requires recording all characteristics of each habitat unit as per the "Instructions for completing the Habitat Inventory Data Form" (Part III). After DFG analysis of over 200 stream habitat inventory data sets, it was determined that similar stream descriptive detail could be accomplished with a sampling level of approximately 10 percent (Appendix O).

The information provided by habitat and channel typing, and biological information collected during spawning surveys and/or juvenile rearing surveys aids in determining if critical habitat needs of a target species are lacking, and if there are areas where improvements can be made.

There are four levels of classification used to describe physical fish habitat. Each higher level in the sequence includes more descriptive categories of habitat types (Figure III-8). Level I categorizes habitat into riffles or pools. Level II categorizes riffles into riffle or flatwater habitat types, for a total of three types (riffle, pool, and flatwater). Level III further differentiates riffle types on the basis of water surface gradient (riffle or cascade), and pool types according to their location in the stream channel (main channel, lateral scour, or backwater). At Level IV, pools are categorized by the cause of formation (obstruction, blockage, constriction, or merging flows); riffles are categorized by gradient; and cascades by gradient and substrate type; and flatwaters are categorized by depth and velocity. Level IV habitat types are the 24 habitat types listed on page III-30 and diagramed on pages III-31 through III-42.

Prior to conducting an inventory, the level of data collection necessary to meet the needs of the investigation should be established. Habitat typing at Level IV will provide the greatest detail and the most complete description of existing habitat. This data can later be aggregated into broader levels of habitat classification if detail is found to be excessive.

CALIFORNIA SALMONID STREAM HABITAT RESTORATION MANUAL

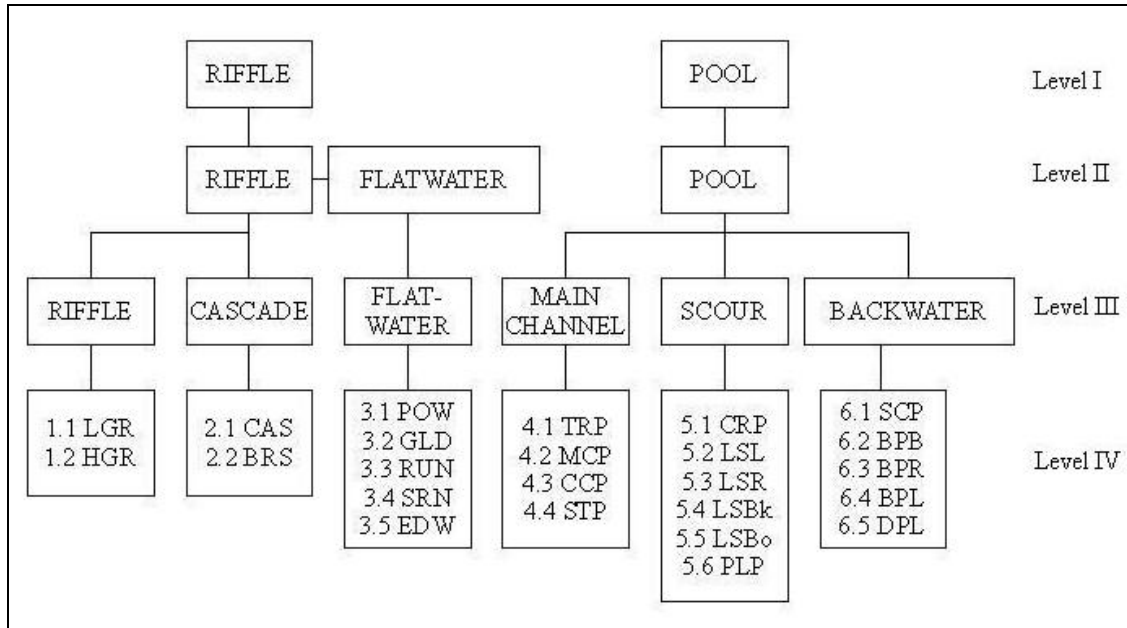

Figure III-8. Habitat types hierarchy.

Generally a stream will not contain all 24 habitat types. The mix of habitat types will be reflective of the overall channel gradient, flow regime, cross-sectional profile, and substrate particle size. Basins that exhibit a wide range in channel gradient will also have a broad mix of habitat types. Stratifying a basin by channel types helps to predict the location of certain habitat types.

Project-level habitat typing is used to evaluate and quantify changes in habitat as the result of fish habitat restoration/enhancement projects. It will provide insight on the relationship between channel features and habitat development. For project-level habitat typing, the minimum size of a habitat unit is equal to the width of the wetted stream channel. For a more detailed habitat analysis, the units can be reduced. The habitat unit size used depends on the nature and objective of the particular study. Regardless of unit size, Level IV habitat types should be used.

Habitat typing is intended to yield detailed information that can be used for fisheries management. Basin-wide habitat typing can provide a variety of data. Some important applications are:

- Physically describe 100 percent of the habitat in a basin.
- Provide baseline data to evaluate habitat responses to restoration efforts.
- Facilitate restoration planning and fisheries management.
- Determine transect locations for Instream Flow Incremental Methodology (IFIM) modeling based on habitat availability and accessibility.

CALIFORNIA SALMONID STREAM HABITAT RESTORATION MANUAL

Definition of Habitat Types

The following list of habitat types and their hierarchy has been adapted from the original system developed by Bisson, et al. (1982), modified by Decker, Overton, et al. (1985), and Sullivan (1988).

Level I Habitat Types:

RIFFLE:

(Riffle, Cascade, Flatwater)

POOL:

(Main Channel Pool, Scour Pool, Backwater Pool)

Level II Habitat Types:

RIFFLE:

(Low-Gradient Riffle, High-Gradient Riffle, Cascade, Bedrock Sheet)

FLATWATER:

(Pocket Water, Run, Step Run, Glide, Edgewater)

POOL:

(Plunge Pool, Mid-Channel Pool, Dammed Pool, Step Pool, Channel Confluence Pool, Trench Pool, Lateral Scour Pool - Root Wad Enhanced, Boulder Formed, Bedrock Formed, and Log Enhanced, Corner Pool, Secondary Channel Pool, Backwater Pool - Boulder Formed, Root Wad Formed, and Log Formed)

Level III and Level IV Habitat Types:

The three or four letter abbreviations in parentheses, (***) , are the standardized abbreviations adopted by DFG. The three digit numbers in brackets, [*. *], are the standardized numbers adopted by DFG. The numbers in braces, {**}, are the numbers listed in the *Pacific Southwest Region Habitat Typing Field Guide*, USDA-USFS. Table on next page.

CALIFORNIA SALMONID STREAM HABITAT RESTORATION MANUAL

LEVEL III and LEVEL IV HABITAT TYPES

RIFFLE

Low Gradient Riffle	(LGR)	[1.1]	{1}
High Gradient Riffle	(HGR)	[1.2]	{2}

CASCADE

Cascade	(CAS)	[2.1]	{3}
Bedrock Sheet	(BRS)	[2.2]	{24}

FLATWATER

Pocket Water	(POW)	[3.1]	{21}
Glide	(GLD)	[3.2]	{14}
Run	(RUN)	[3.3]	{15}
Step Run	(SRN)	[3.4]	{16}
Edgewater	(EDW)	[3.5]	{18}

MAIN CHANNEL POOL

Trench Pool	(TRP)	[4.1]	{8}
Mid-Channel Pool	(MCP)	[4.2]	{17}
Channel Confluence Pool	(CCP)	[4.3]	{19}
Step Pool	(STP)	[4.4]	{23}

SCOUR POOL

Corner Pool	(CRP)	[5.1]	{22}
L. Scour Pool - Log Enhanced	(LSL)	[5.2]	{10}
L. Scour Pool - Root Wad Enhanced	(LSR)	[5.3]	{11}
L. Scour Pool - Bedrock Formed	(LSBk)	[5.4]	{12}
L. Scour Pool - Boulder Formed	(LSBo)	[5.5]	{20}
Plunge Pool	(PLP)	[5.6]	{9}

BACKWATER POOLS

Secondary Channel Pool	(SCP)	[6.1]	{4}
Backwater Pool - Boulder Formed	(BPB)	[6.2]	{5}
Backwater Pool - Root Wad Formed	(BPR)	[6.3]	{6}
Backwater Pool - Log Formed	(BPL)	[6.4]	{7}
Dammed Pool	(DPL)	[6.5]	{13}

ADDITIONAL UNIT DESIGNATIONS

Dry	(DRY)	[7.0]	
Culvert	(CUL)	[8.0]	
Not Surveyed	(NS)	[9.0]	
Not Surveyed due to a marsh	(MAR)	[9.1]	

Level IV Habitat Type Descriptions:

The following habitat type descriptions are taken from the *Pacific Southwest Region Habitat Typing Field Guide*, USDA-USFS.

CALIFORNIA SALMONID STREAM HABITAT RESTORATION MANUAL

LOW-GRADIENT RIFFLE (LGR) [1.1] {1}

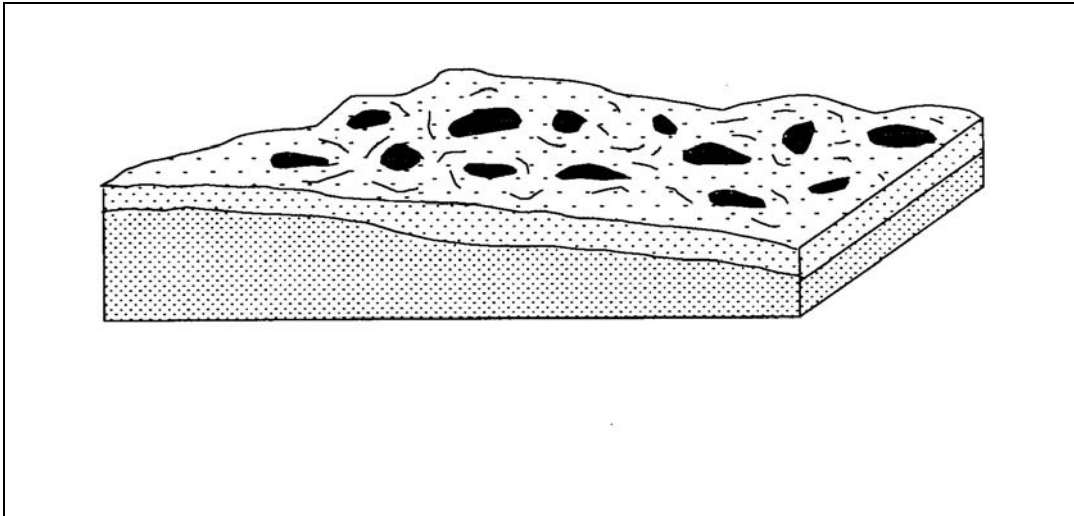

Shallow reaches with swiftly flowing, turbulent water with some partially exposed substrate. Gradient $< 4\%$, substrate is usually cobble dominated.

HIGH-GRADIENT RIFFLE (HGR) [1.2] {2}

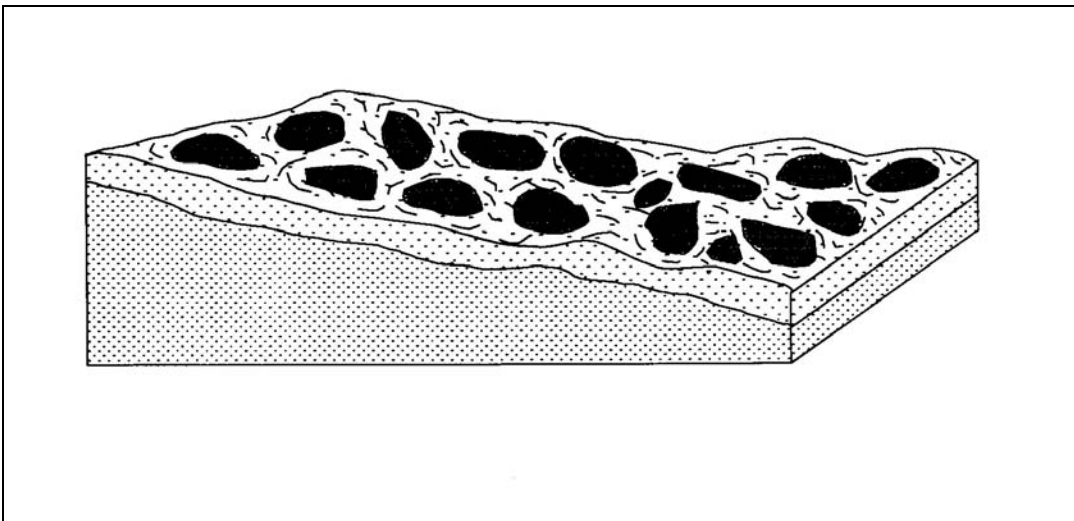

Steep reaches of moderately deep, swift, and very turbulent water. Amount of exposed substrate is relatively high. Gradient is $> 4\%$, and substrate is boulder dominated.

CALIFORNIA SALMONID STREAM HABITAT RESTORATION MANUAL

CASCADE (CAS) [2.1] {3}

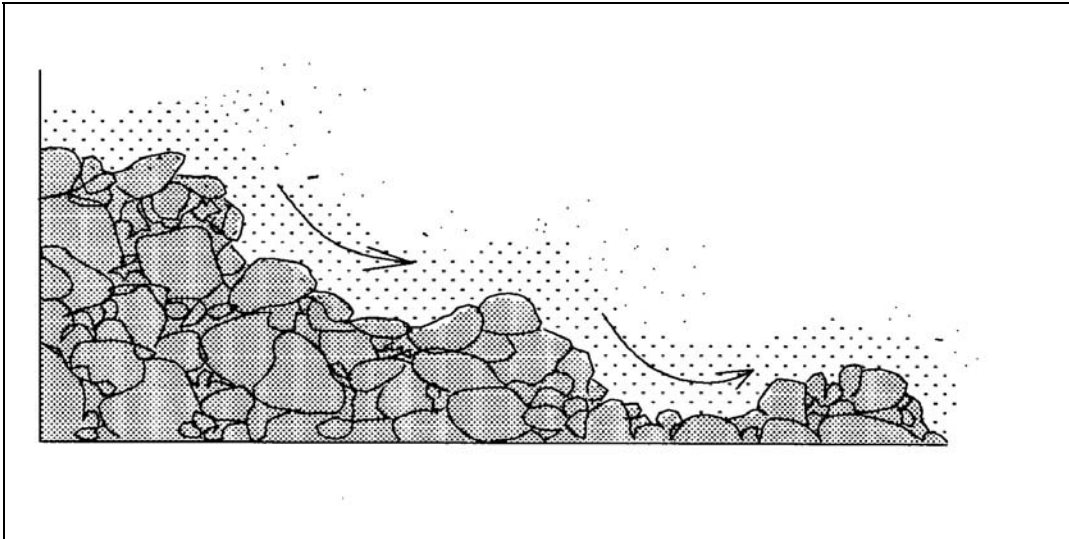

The steepest riffle habitat, consisting of alternating small waterfalls and shallow pools. Substrate is usually bedrock and boulders.

BEDROCK SHEET (BRS) [2.2] {24}

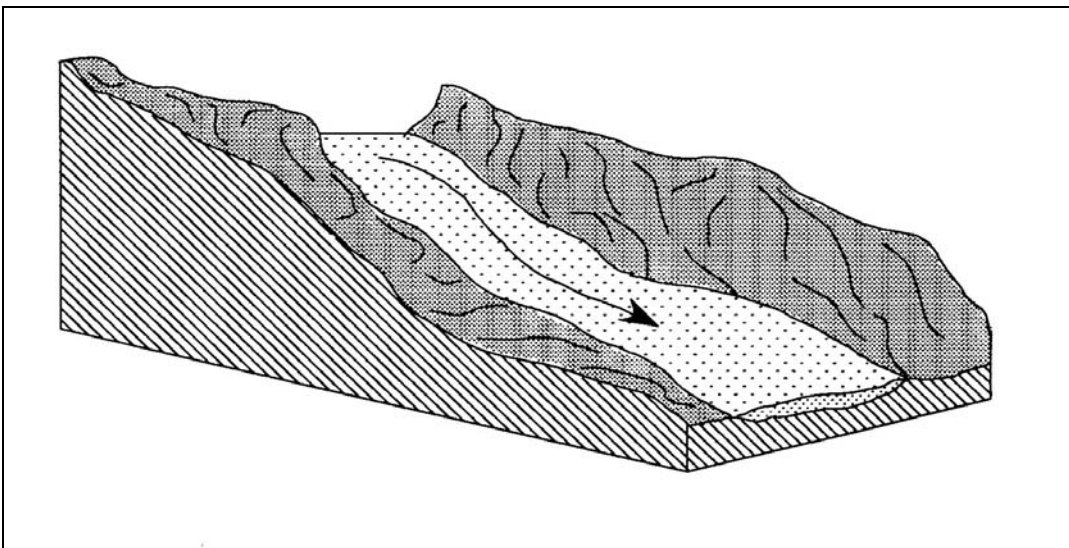

A thin sheet of water flowing over a smooth bedrock surface. Gradients are highly variable.

**CALIFORNIA SALMONID STREAM
HABITAT RESTORATION MANUAL**

POCKET WATER (POW) [3.1] {21}

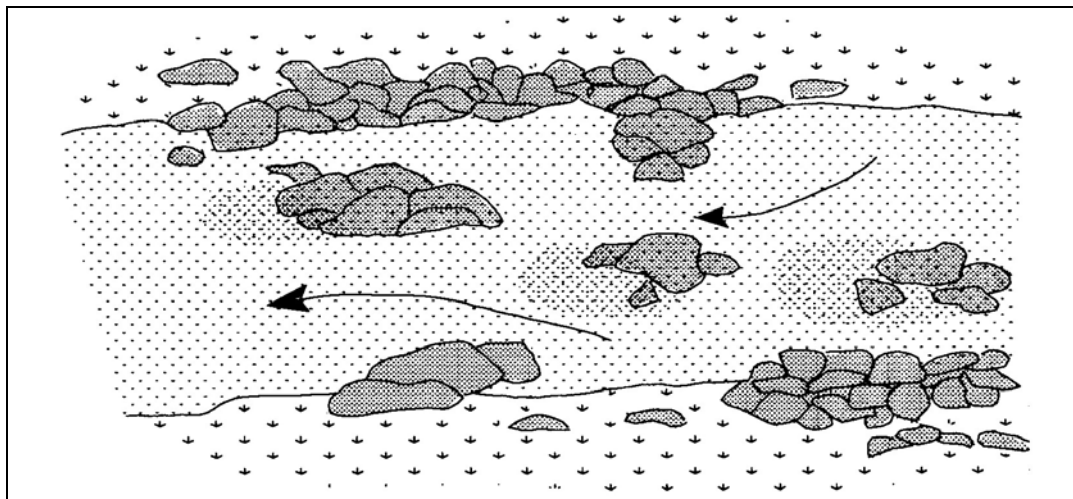

A section of swift-flowing stream containing numerous boulders or other large obstructions which create eddies or scour holes (pockets) behind the obstructions.

GLIDE (GLD) [3.2] {14}

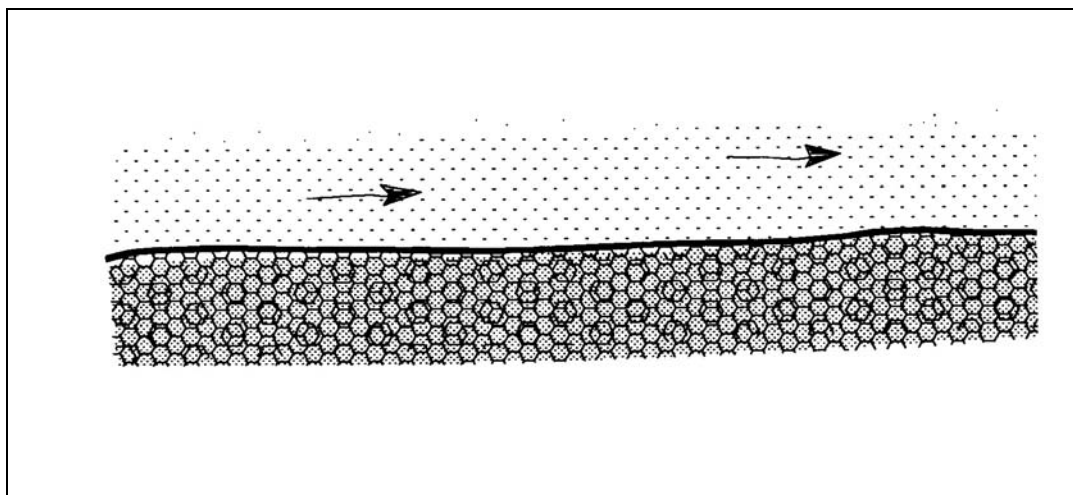

A wide, uniform channel bottom. Flow with low to moderate velocities, lacking pronounced turbulence. Substrate usually consists of cobble, gravel, and sand.

CALIFORNIA SALMONID STREAM HABITAT RESTORATION MANUAL

RUN (RUN) [3.3] {15}

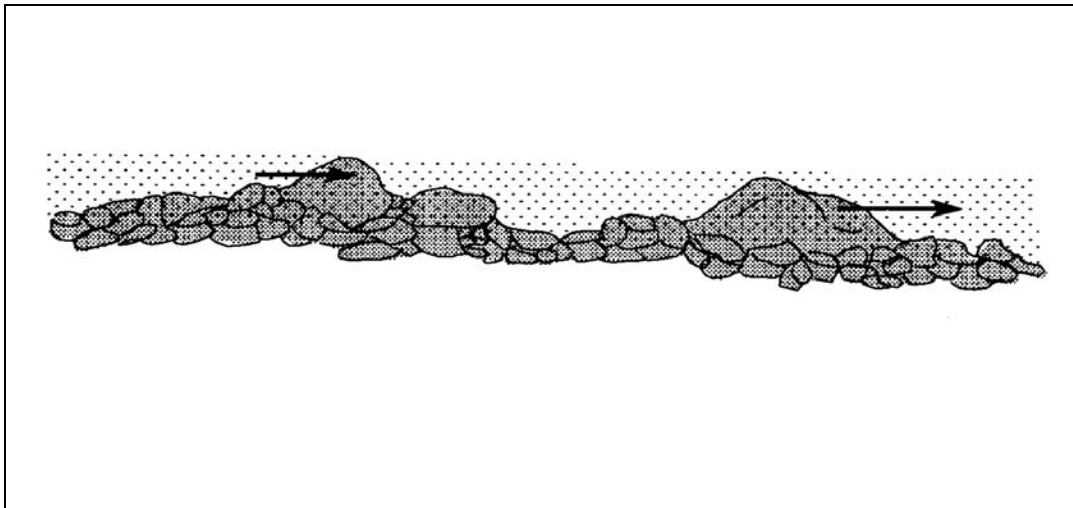

Swiftly flowing reaches with little surface agitation and no major flow obstructions. Often appears as flooded riffles. Typical substrate consists of gravel, cobble, and boulders.

STEP RUN (SRN) [3.4] {16}

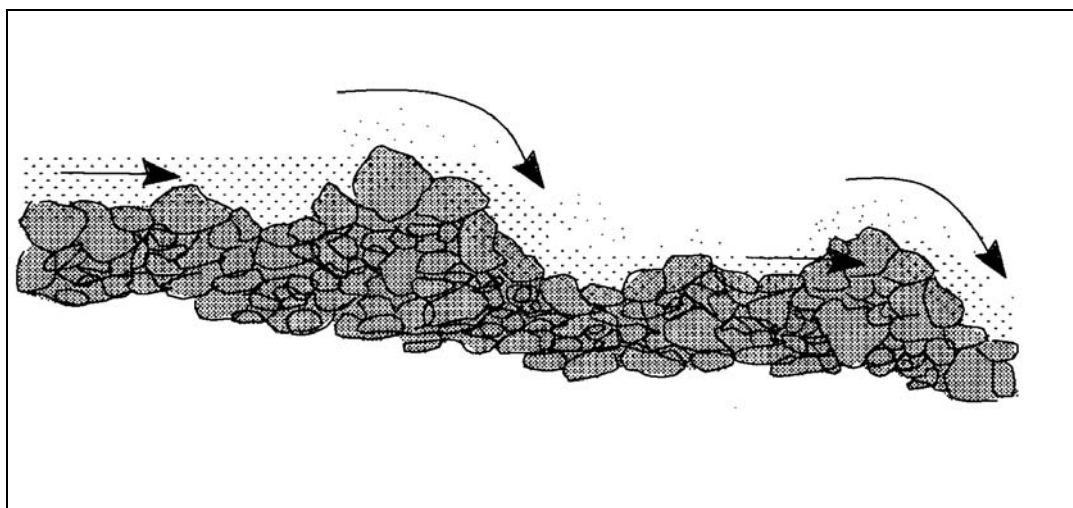

A sequence of runs separated by short riffle steps. Substrate is usually cobble and boulder dominated.

CALIFORNIA SALMONID STREAM HABITAT RESTORATION MANUAL

EDGEWATER (EDW) [3.5] {18}

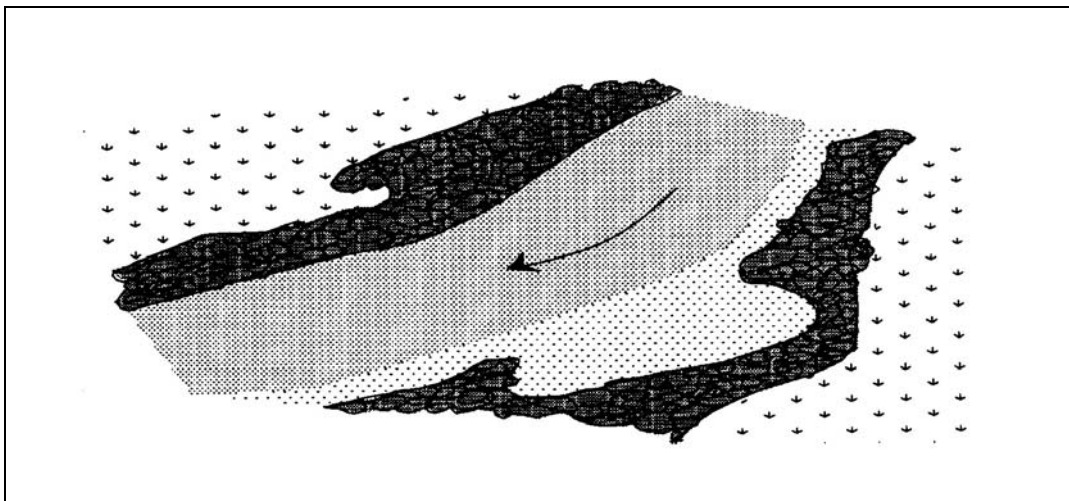

Quiet, shallow area found along the margins of the stream, typically associated with riffles. Water velocity is low and sometimes lacking. Substrate varies from cobbles to boulders.

TRENCH POOLS (TRP) [4.1] {8}

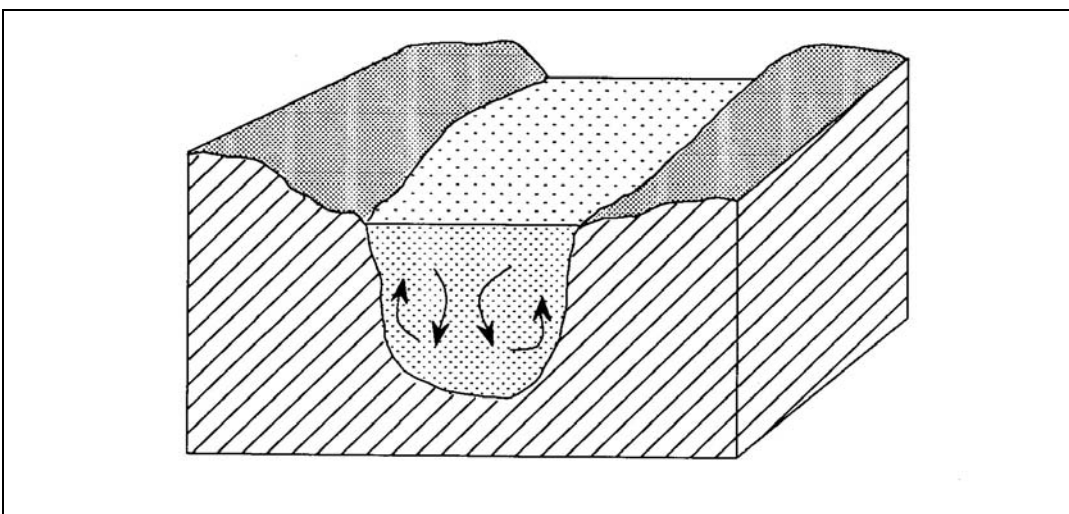

Channel cross sections typically U-shaped with bedrock or coarse grained bottom flanked by bedrock walls. Current velocities are swift and the direction of flow is uniform.

CALIFORNIA SALMONID STREAM HABITAT RESTORATION MANUAL

MID-CHANNEL POOL (MCP) [4.2] {17}

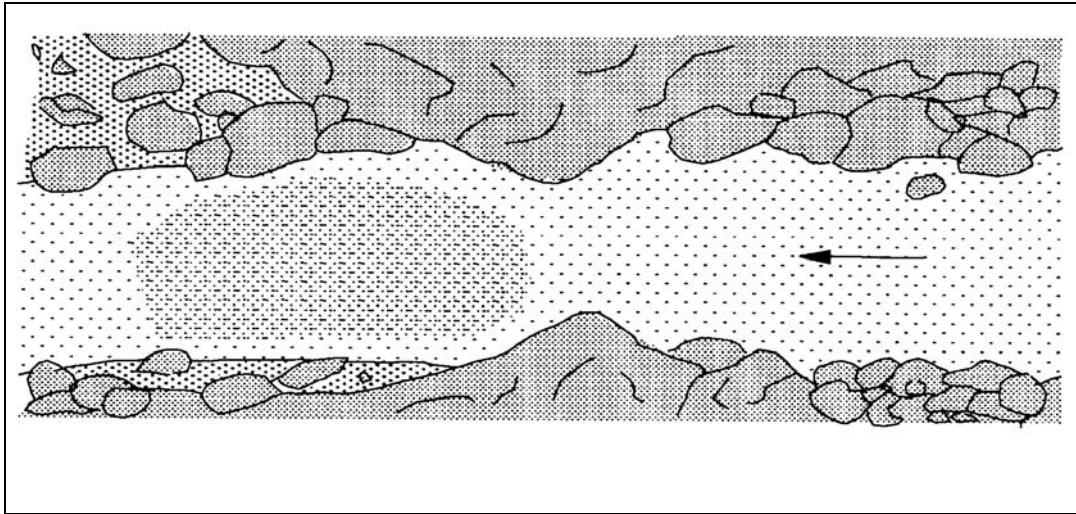

Large pools formed by mid-channel scour. The scour hole encompasses more than 60% of the wetted channel. Water velocity is slow, and the substrate is highly variable.

CHANNEL CONFLUENCE POOL (CCP) [4.3] {19}

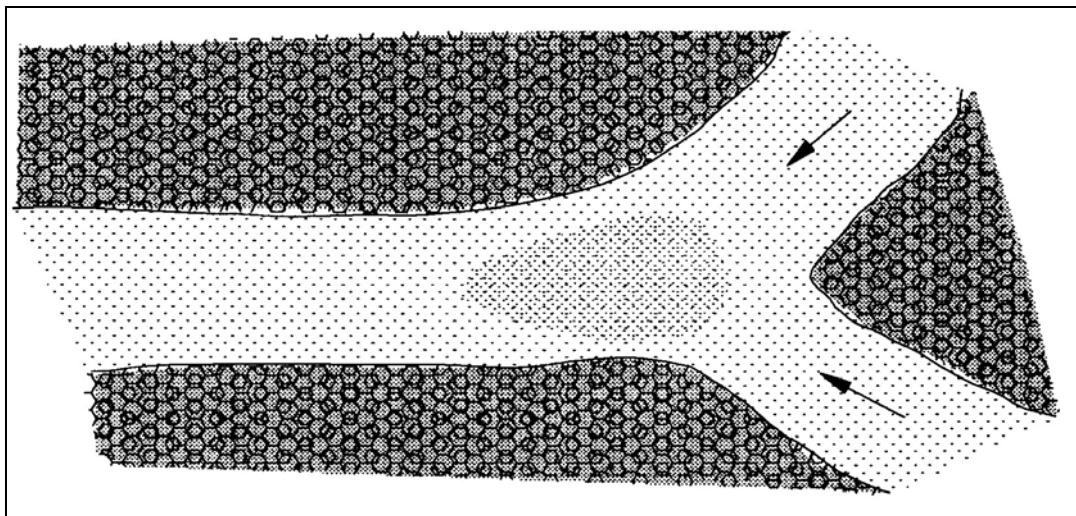

Large pools formed at the confluence of two or more channels. Scour can be due to plunges, lateral obstructions or scour at the channel intersections. Velocity and turbulence are usually greater than those in other pool types.

CALIFORNIA SALMONID STREAM HABITAT RESTORATION MANUAL

STEP POOL (STP) [4.4] {23}

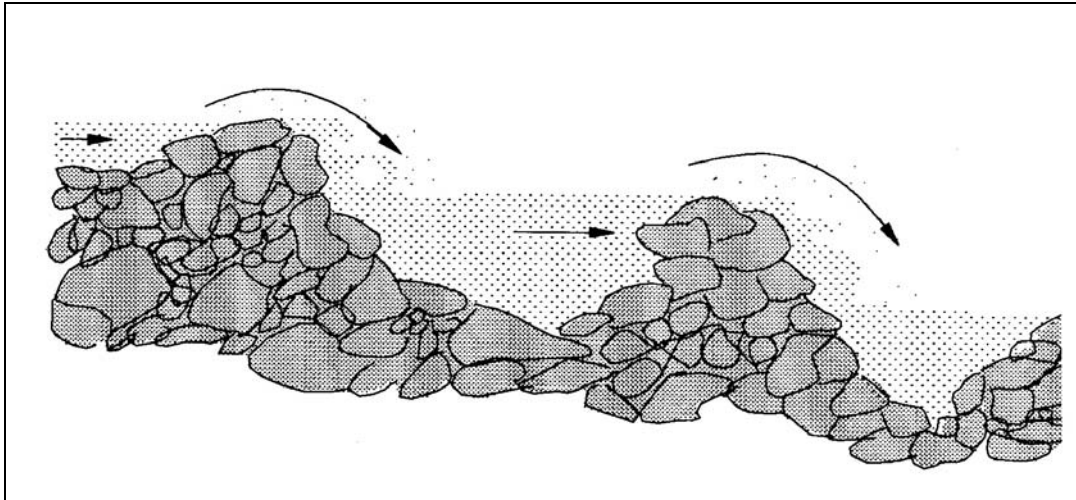

A series of pools separated by short riffles or cascades. Generally found in high-gradient, confined mountain streams dominated by boulder substrate.

CORNER POOL (CRP) [5.1] {22}

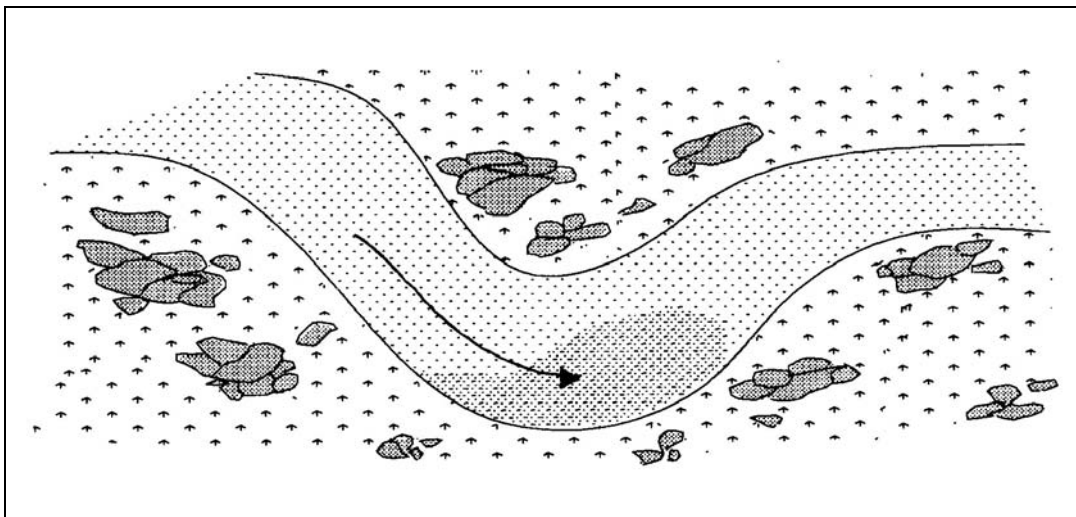

Lateral scour pools formed at a bend in the channel. These pools are common in lowland valley bottoms where stream banks consist of alluvium and lack hard obstructions.

CALIFORNIA SALMONID STREAM HABITAT RESTORATION MANUAL

LATERAL SCOUR POOL - LOG ENHANCED (LSL) [5.2] {10}

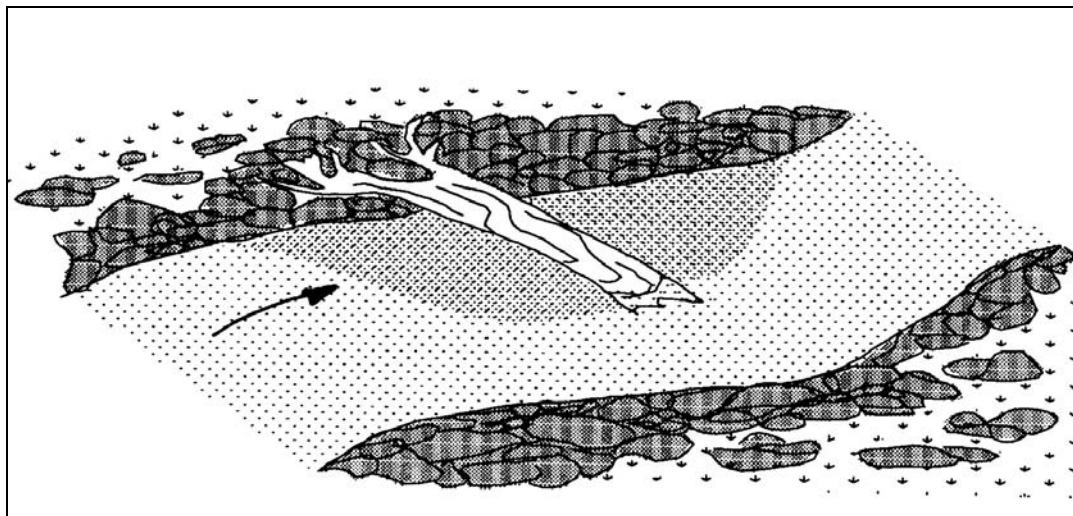

Formed by flow impinging against a partial channel obstruction consisting of large woody debris. The associated scour is generally confined to < 60% of the wetted channel width.

LATERAL SCOUR POOL - ROOT WAD ENHANCED (LSR) [5.3] {11}

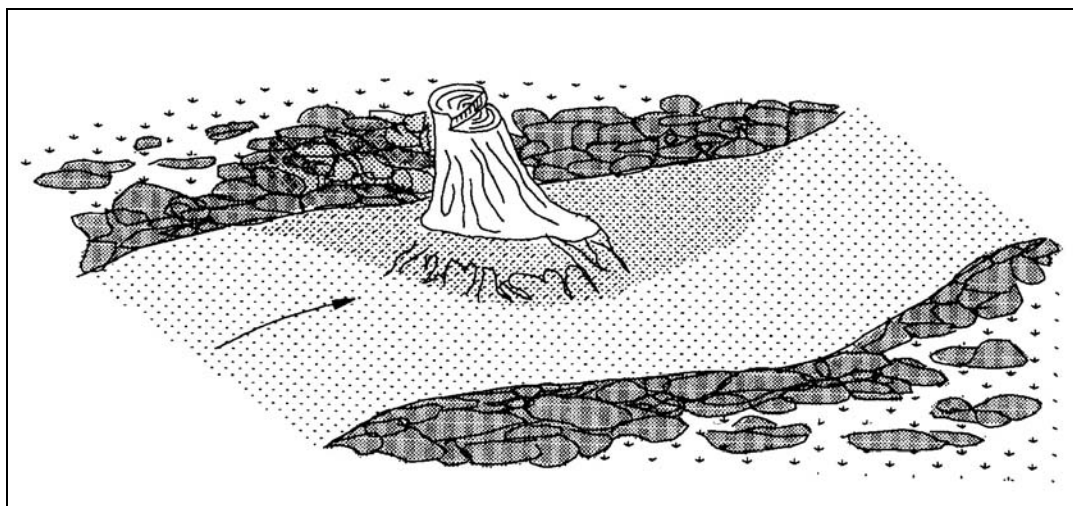

Formed by flow impinging against a partial channel obstruction consisting of a root wad. The associated scour is generally confined to < 60% of the wetted channel width.

CALIFORNIA SALMONID STREAM HABITAT RESTORATION MANUAL

LATERAL SCOUR POOL - BEDROCK FORMED (LSBk) [5.4] {12}

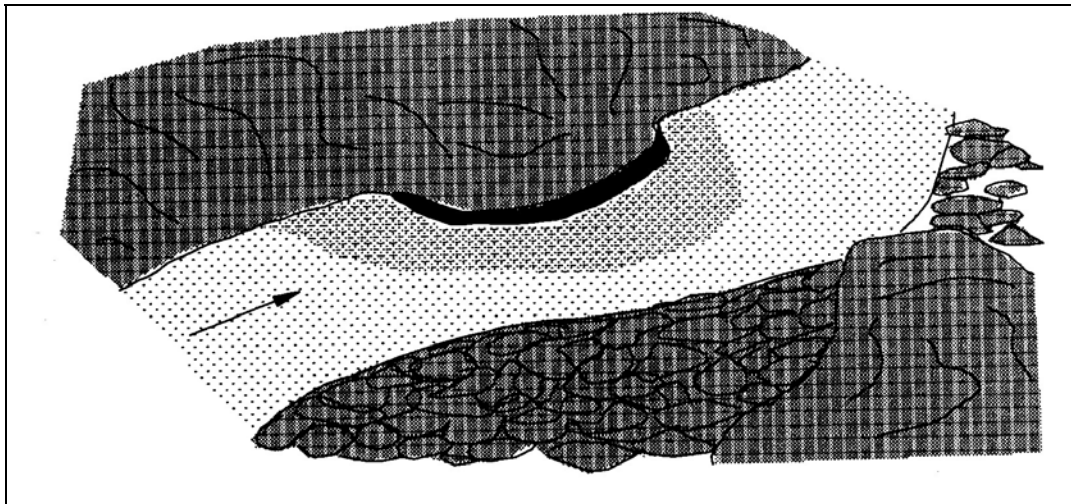

Formed by flow impinging against a bedrock stream bank. The associated scour is generally confined to < 60% of the wetted channel width.

LATERAL SCOUR POOL - BOULDER FORMED (LSBo) [5.5] {20}

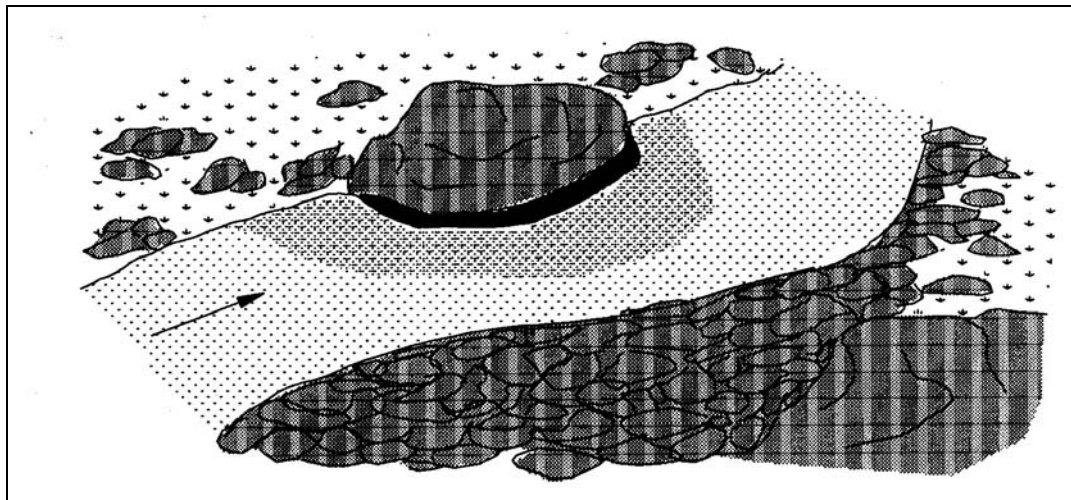

Formed by flow impinging against a partial channel obstruction consisting of a boulder. The associated scour is generally confined to < 60% of the wetted channel width.

CALIFORNIA SALMONID STREAM HABITAT RESTORATION MANUAL

PLUNGE POOL (PLP) [5.6] {9}

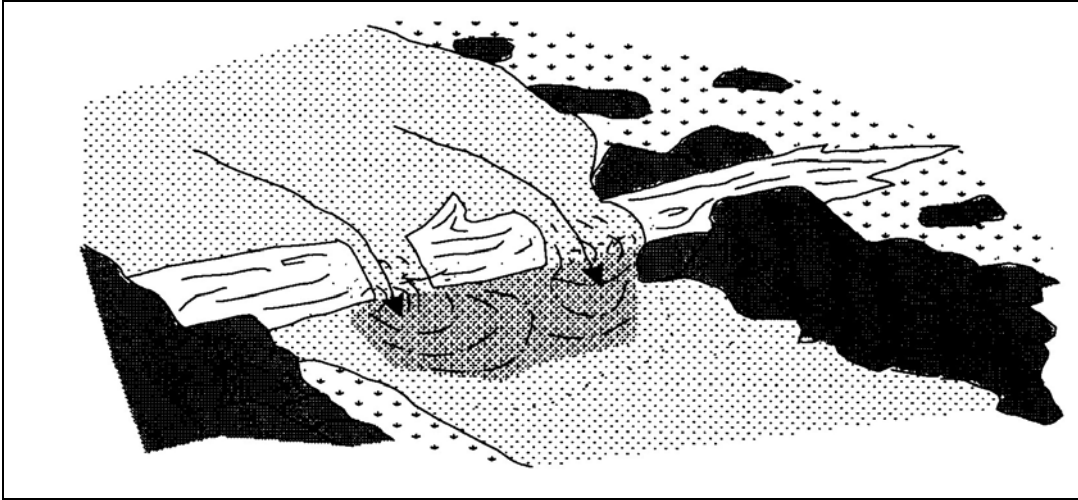

Found where the stream passes over a complete or nearly complete channel obstruction and drops steeply into the streambed below, scouring out a depression; often large and deep. Substrate size is highly variable.

SECONDARY CHANNEL POOL (SCP) [6.1] {4}

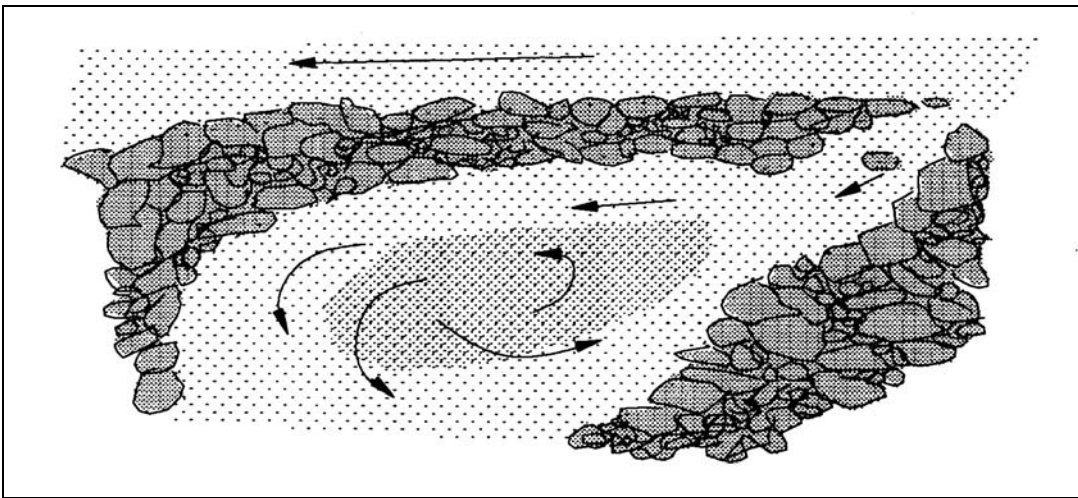

Pools formed outside of the average wetted channel width. During summer, these pools will dry up or have very little flow. Mainly associated with gravel bars and may contain sand and silt substrate.

CALIFORNIA SALMONID STREAM HABITAT RESTORATION MANUAL

BACKWATER POOL - BOULDER FORMED (BPB) [6.2] {5}

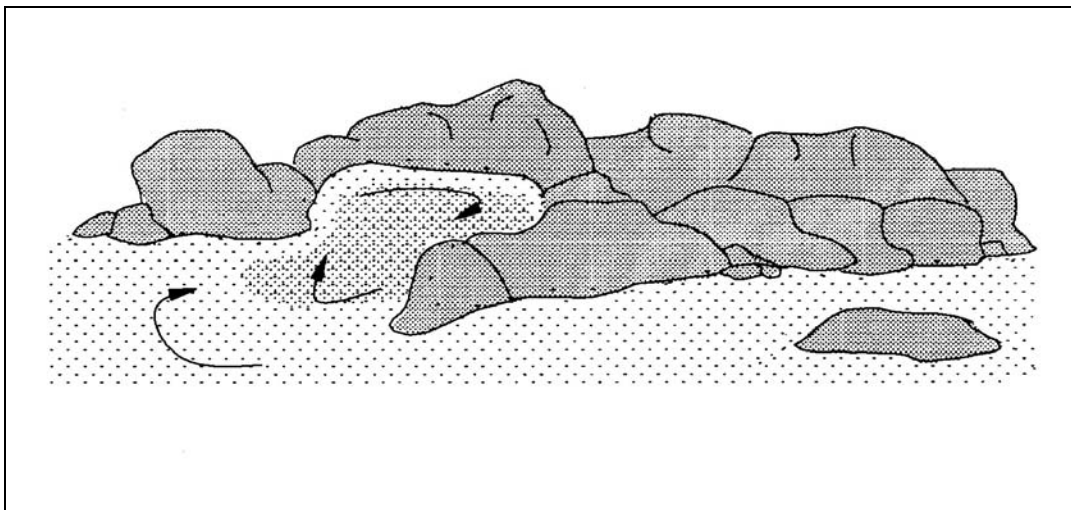

Found along channel margins and caused by eddies around a boulder obstruction. These pools are usually shallow and are dominated by fine-grain substrate. Current velocities are quite low.

BACKWATER POOL - ROOT WAD FORMED (BPR) [6.3] {6}

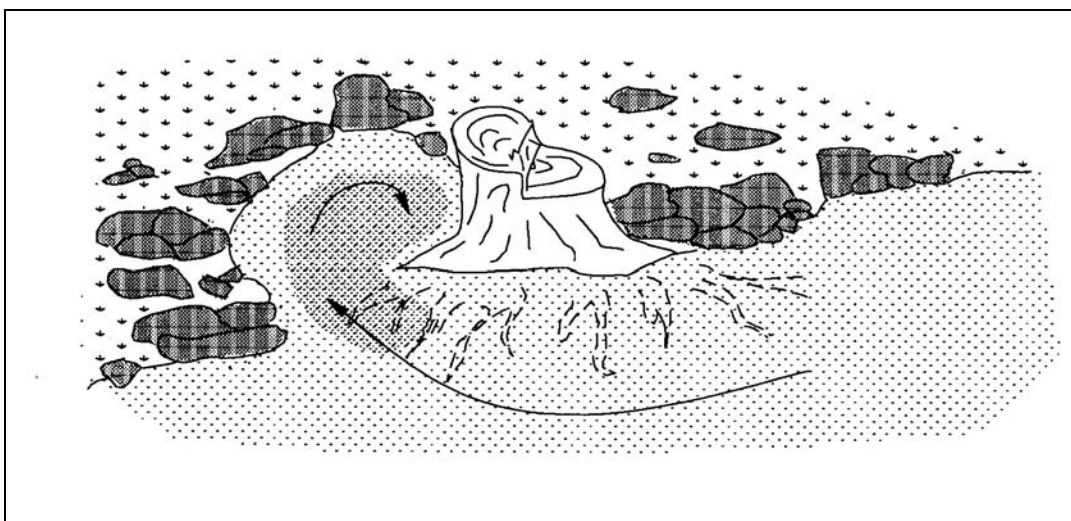

Found along channel margins and caused by eddies around a root wad obstruction. These pools are usually shallow and are dominated by fine-grained substrate. Current velocities are quite low.

CALIFORNIA SALMONID STREAM HABITAT RESTORATION MANUAL

BACKWATER POOL - LOG FORMED (BPL) [6.4] {7}

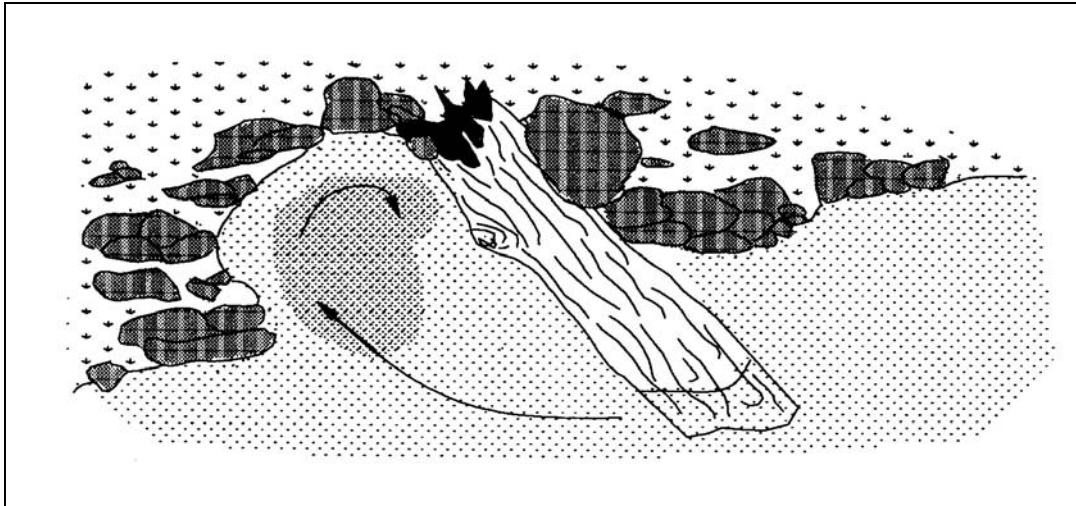

Found along channel margins and caused by eddies around a large woody debris obstruction. These pools are usually shallow and are dominated by fine-grained substrate. Current velocities are quite low.

DAMMED POOLS (DPL) [6.5] {13}

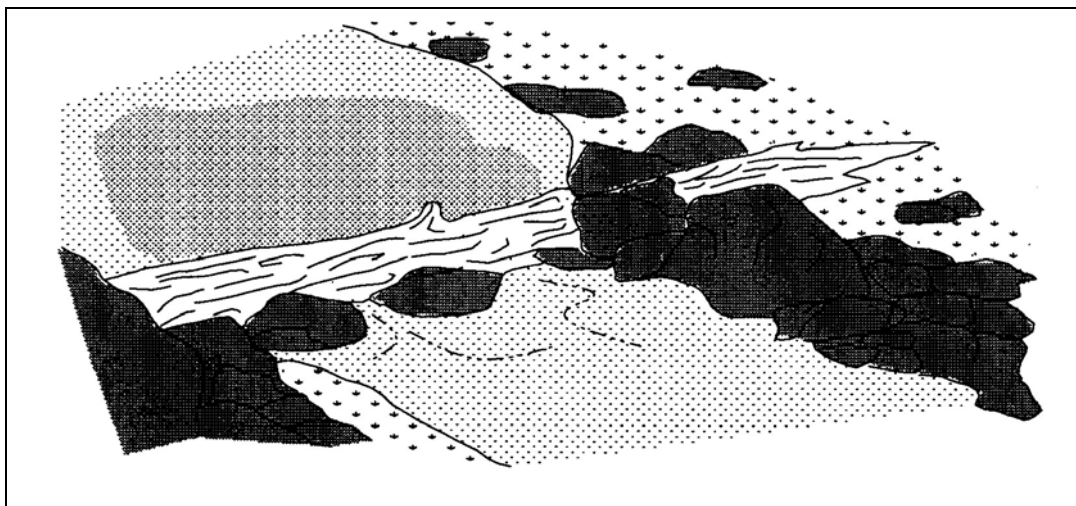

Water impounded from a complete or nearly complete channel blockage (log debris jams, rock landslides or beaver dams). Substrate tends to be dominated by smaller gravel and sand.

CALIFORNIA SALMONID STREAM HABITAT RESTORATION MANUAL

Instream Shelter

Instream shelter within each habitat unit can be rated according to a standard system. This rating system is a field procedure for habitat inventories which utilizes objective field measurements. It is intended to rate, for each habitat unit, complexity of shelter that serves as instream habitat or that creates areas of diverse velocities which are focal points for salmonids. In this rating system, instream shelter is composed of those elements within a stream channel that provide protection from predation for salmonids, areas of reduced water velocities in which fish can rest and conserve energy, and separation between territorial units to reduce density related competition. This rating does not consider factors related to changes in discharge, such as water depth.

Instream Shelter Complexity. A value rating can be assigned to instream shelter complexity. This rating is a relative measure of the quantity and composition of the instream shelter.

Value	Instream Shelter Complexity Value Examples:
0	<ul style="list-style-type: none">● No shelter.
1	<ul style="list-style-type: none">● One to five boulders.● Bare undercut bank or bedrock ledge.● Single piece of large wood (>12" diameter and 6' long) defined as large woody debris (LWD).
2	<ul style="list-style-type: none">● One or two pieces of LWD associated with any amount of small wood (<12" diameter) defined as small woody debris (SWD).● Six or more boulders per 50 feet.● Stable undercut bank with root mass, and less than 12" undercut.● A single root wad lacking complexity.● Branches in or near the water.● Limited submersed vegetative fish cover.● Bubble curtain.
3	<p>Combinations of (must have at least two cover types):</p> <ul style="list-style-type: none">● LWD/boulders/root wads.● Three or more pieces of LWD combined with SWD.● Three or more boulders combined with LWD/SWD.● Bubble curtain combined with LWD or boulders.● Stable undercut bank with greater than 12" undercut, associated with root mass or LWD.● Extensive submersed vegetative fish cover.

Instream Shelter Percent Covered. Instream shelter percent covered is a measure of the area of a habitat unit occupied by instream shelter. The area is estimated from an overhead view.

CALIFORNIA SALMONID STREAM HABITAT RESTORATION MANUAL

Instructions for Completing the Habitat Inventory Data Form

- 1) **Form No.** - Print in the form number. Number the forms sequentially beginning with "01" on the first page and "02" on the second and so on.
- 2) **Date** - Enter the day's date: mm/dd/yy.
- 3) **Stream Name** - Enter the stream name identified on the 7.5 minute USGS quadrangle. Unnamed streams should be entered as unnamed tributary to name of receiving stream.
- 4) **Legal** - Enter the township, range and section of the stream confluence or from where the survey started identified on the 7.5 minute USGS quadrangle.
- 5) **Surveyors** - Enter the names of the surveyors with the note taker listed first.
- 6) **Lat** - Enter the latitude taken from the 7.5-minute USGS quadrangle at the confluence of the stream (Part II- Instructions for Completing Watershed Overview Work Sheet).
- 7) **Long** - Enter the longitude taken from the 7.5-minute USGS quadrangle at the confluence of the stream (Part II- Instructions for Completing Watershed Overview Work Sheet).
- 8) **Quad** - Enter the name of the 7.5-minute USGS quadrangle on which the confluence of the stream appears.
- 9) **Channel Type** - Record the channel type determined from completing the Stream Channel Type Work Sheet (Part III). Record in the comments the habitat unit number in which the channel type change occurs in.
- 10) **Reach** - Enter the reach number beginning with 1 for the lowermost channel type in the basin. Each stream channel type change proceeding upstream will be designated by a new stream reach number.
- 11) **BFW** - Measure and enter the stream width at bankfull discharge elevation in the first appropriate velocity crossover on each new data sheet. Use the methods described in the Stream Channel Type Worksheet (Part III).
- 12) **@HU#** - Record the habitat unit number at which the bankfull width was measured.
- 13) **Time** - At the beginning of each page enter the time in military time (24-hour clock).
- 14) **Water Temperature** - At the beginning of each page record the water temperature to the nearest degree Fahrenheit. Take water temperatures in the middle of the habitat unit, in flowing water.
- 15) **Air Temperature** - At the beginning of each page record the air temperature to the nearest degree Fahrenheit. Take air temperatures in the middle of the habitat unit, within one foot of the water surface.

CALIFORNIA SALMONID STREAM HABITAT RESTORATION MANUAL

- 16) **Flow Measurement** - Record the flow at the beginning and the end of the survey, at the same location. Record in cubic feet/second.
- 17) **Page Length** - Sum the mean lengths for the page.
- 18) **Total Length** - Sum all the page lengths through the current page.
- 19) **Habitat Unit Number** - Enter the habitat unit number. Record these numbers in sequential order, beginning with "0001" at the survey start. When numbering side channels begin with the number of the unit where the split or divide begins; use a new column and entirely fill it out for each subsequent side channel unit, and number the units sequentially adding a ".1", ".2", etc. as appropriate to describe the exact position of the side channel units. Example of a side channel with two habitat units:

Habitat Unit Number	0005	0006	0006.1	0006.2	0007
Habitat Unit Type	5.3	1.1			4.2
Side Channel Type			1.1	3.2	

- 20) **Habitat Unit Type** - Determine the type of habitat unit and enter the appropriate habitat type number code. If the unit is dry, use 7.0 for the habitat unit type. If a stream length is contained within a culvert, use 8.0 for the habitat unit type. If the length of stream was not surveyed due to lack of access, use 9.0 for the habitat type. If the length of stream was not surveyed due to a marsh, use 9.1 for the habitat unit type. Record all pertinent information in the comments.
- 21) **Side Channel Type** - Determine the type of habitat unit and enter the appropriate habitat type number code.
- 22) **Mean Length** - Enter the thalweg length of the habitat unit, in feet.
- 23) **Mean Width** - Measure two or more wetted channel widths within the habitat unit. Calculate and enter the mean width for the habitat unit, in feet.
- 24) **Mean Depth** - Take several random depth measurements across the unit with a stadia rod. Calculate and enter the mean depth, in feet.
- 25) **Maximum Depth** - Enter the measured maximum depth for each habitat unit, in feet.
- 26) **Depth Pool Tail Crest** - Measure the maximum thalweg depth at the pool tail crest, in feet. This measurement is taken only in pool habitat units and is used to determine the pool's residual volume.
- 27) **Pool Tail Embeddedness** - Percent cobble embeddedness is determined at pool tail-outs where spawning is likely to occur. Sample at least five small cobbles (2.5" to 5.0") in diameter and estimate the amount of the stone buried in the sediment. This is done by

CALIFORNIA SALMONID STREAM HABITAT RESTORATION MANUAL

removing the cobble from the streambed and observing the line between the "shiny" buried portion and the duller exposed portion. Estimate the percent of the lower shiny portion using the corresponding number for the 25% ranges. Average the samples for a mean cobble embeddedness rating. Additionally, a value of 5 is assigned to tail-outs deemed unsuited for spawning due to inappropriate substrate particle size, having a bedrock tail-out, or other considerations:

- 1 = 0 to 25%
- 2 = 26 to 50%
- 3 = 51 to 75%
- 4 = 76 to 100%
- 5 = unsuitable for spawning

- 28) **Pool Tail Substrate** - Enter the letter code (A through G) for the dominant substrate composition of the tail-out for all pools.
- 29) **Large Woody Debris Count Diameter >1' and Length from 6'to 20'** – Record the number of pieces of large woody debris that have a diameter greater than one foot and a length between six and twenty feet, and are wholly or partially within the bankfull discharge elevation of that habitat unit.
- 30) **Large Woody Debris Count Diameter >1' and Length>20'** – Record the number of pieces of large woody debris that have a diameter greater than one foot and a length greater than twenty feet, and are located wholly or partially within the bankfull discharge elevation of that habitat unit.
- 31) **Shelter Value** - Enter the number code (0 to 3) that corresponds to the dominant structural shelter type that exists in the unit (Part III- Instream Shelter Complexity).
- 32) **Percent Unit Covered** - Enter the percentage of the unit occupied by the structural shelter. Classify 100 percent of the shelter by the types indicated on the form. Note: bubble curtain includes white water.
- 33) **Substrate Composition** - Enter a "1" for the dominant substrate and a "2" for the co-dominant substrate. Note: changes in the dominant and co-dominant substrate may indicate that the channel type has changed.
- 34) **Percent Exposed Substrate** - Enter the estimated percentage of the bottom substrate of the unit that is exposed above the water surface.
- 35) **Percent Total Canopy** - Enter the percentage of the stream area that is influenced by the tree canopy. The canopy is measured using a spherical densiometer at the upstream end of each habitat unit in the center of the wetted channel. (Appendix M).
- 36) **Percent Hardwood Trees** - Estimate the percent of the total canopy consisting of hardwood, or broadleaved, trees. For watershed where the entire canopy consists of hardwood trees, use this field to distinguish deciduous trees, or trees that provide partial year shade and leaf-drop.

CALIFORNIA SALMONID STREAM HABITAT RESTORATION MANUAL

- 37) **Percent Coniferous Trees** - Estimate the percent of the total canopy consisting of coniferous, or needle leafed, trees. For watersheds where the entire canopy consists of hardwood trees, use this field to distinguish evergreen trees, or trees that provide year-round shade.
- 38) **Right Bank Composition** - Observed from the base of the stream bank to the bankfull discharge level. Enter the number (1 through 4) for the right bank composition type corresponding to the list located on the lower left hand side of the form. Enter one number only. The right bank is the right side of the stream when facing downstream.
- 39) **Right Bank Dominant Vegetation** - Enter the number (5 through 9) for the right bank dominant vegetation type, from bankfull to 20 feet upslope, corresponding to the list located on the lower left hand side of the form. Enter one number only.
- 40) **Percent Right Bank Vegetated** - Estimate the total percentage of the right bank covered with vegetation from bankfull discharge level to 20 feet upslope.
- 41) **Left Bank Composition** - Observed from the lower bank to the bankfull discharge level. Enter the number (1 through 4) for the left bank composition type corresponding to the list located on the lower left hand side of the form. Enter one number only. The left bank is the left side of the stream when facing downstream.
- 42) **Left Bank Dominant Vegetation** - Enter the number (5 through 9) for the left bank dominant composition type, from bankfull to 20 feet upslope, corresponding to the list located on the lower left hand side of the form. Enter one number only.
- 43) **Percent Left Bank Vegetated** - Estimate the total percentage of the left bank covered with vegetation from bankfull discharge level to 20 feet upslope.
- 44) **Comments** - Add comments which characterize important habitat unit observations. There are ten comment categories. Comments are begun with an initial letter code which identifies its assigned category.
- a. "S" for an instream habitat **structure** or bank stabilization project
 - b. "C" for a **channel** type change
 - c. "D" to document a water **diversion**
 - d. "T" to record a **tributary**
 - e. "E" for bank **erosion** or a landslide observation
 - f. "B" to document a **biological** observation or sampling site
 - g. "P" for a fish **passage** problem
 - h. "A" to record a stream **access** point
 - i. "G" for a location recorded with a **GPS** receiver
 - j. "O" for all **other** comments that do not fall into an above category.
- 45) The back of the data sheet has an additional area for comments that will not fit on the front, and an area for diagrams to describe a comment.

HABITAT INVENTORY DATA FORM

Form # _____ of _____

Date / /		Stream Name:					T: _____ R: _____ S: _____	
Surveyors:					Lat: _____		Long: _____	
Quad:			Channel Type:		Reach: _____		BFW: _____ @HU#:	
Time:	H ₂ O F°:	Air F°:	Flow:	Pg Length:		Total Length:		
Habitat Unit Number								
Habitat Unit Type								
Side Channel Type								
Mean Length								
Mean Width								
Mean Depth								
Maximum Depth								
Depth Pool Tail Crest								
Pool Tail Embeddedness								
Pool Tail Substrate								
LWD Count D>1&L6to20								
LWD Count D>1&L>20								
Shelter Rating	Shelter Value							
	% Unit Covered							
	% undercut bank							
	% swd (d<12")							
	% lwd (d>12")							
	% root mass							
	% terr. vegetation							
	% aqua. vegetation							
	% bubble curtain							
	% boulders							
% bedrock ledges								
Substrate Composition 2 Most Dominant	A) Silt/Clay							
	B) Sand							
	C) Gravel (0.08-2.5")							
	D) Sm Cobble							
	E) Lg Cobble (5-10")							
	F) Boulder (>10")							
	G) Bedrock							
Percent Exposed Substrate								
Percent Total Canopy								
% Hardwood Trees								
% Coniferous Trees								
Bank Composition & Vegetation	Rt Bk Composition							
	Rt Bk Dominant Vg							
	% Rt Bk Vegetated							
	Lft Bk Composition							
	Lft Bk Dominant Vg							
	% Lft Bk Vegetated							
Bank Composition Types		Comments: Structures Channel Diversions Tribs Erosion Biota Passage Access GPS Other						
1) Bedrock								
2) Boulder								
3) Cobble /Gravel								
4) Silt/Clay/Sand								
Vegetation Types								
5) Grass								
6) Brush								
7) Hardwood Trees								
8) Coniferous Trees								
9) No Vegetation								

CALIFORNIA SALMONID STREAM HABITAT RESTORATION MANUAL

LARGE WOODY DEBRIS (LWD) STREAM AND RIPARIAN INVENTORY

Background

The importance of large woody debris (LWD) in the development of a stream's morphology and biological productivity has been well documented over the last twenty years. It strongly influences stream habitat characteristics and biotic composition. Bilby (1984) and Rainville et al. (1985) found that in nearly 80 percent of the pools surveyed in small streams, LWD was the structural agent forming the pool or associated with the pool. The influence that LWD has on the diversity of juvenile salmonid populations, with particular emphasis on the impact of timber harvest activities on that diversity, has been documented by Reeves et al. (1993). Fish populations are benefitted by both the cover and habitat diversity created by LWD and by the substrate environment for benthic invertebrates that serve as food (Sedell et al. 1984, Sedell et al. 1988, and Bisson et al. 1987).

Relatively large pieces of woody debris in streams influence the physical form of the channel, movement of sediment, retention of gravel, and composition of the biological community (Bilby and Ward, 1989). The relationship between size of individual LWD and its effects on channel morphology are influenced by a number of variables such as stream-flow energy, sinuosity, bank composition, and channel width. Bilby and Ward (1989) and Likens and Bilby (1982) describe LWD and its relationship to pool formation, gravel retention, channel orientation, and channel width. Once LWD enters the stream, their orientation and spacing may be more significant than their volume in influencing channel morphology and aquatic habitats (Platts et al. 1987).

LWD in this methodology is defined as a piece of wood having a minimum diameter of twelve inches and a minimum length of six feet. Root wads must meet the minimum diameter criteria at the base of the trunk but need not be at least six feet long. Four diameter ranges and two length ranges were selected to categorize LWD sizes in this inventory method:

Diameter Category		Length Category	
1.	1 - 2 feet	1.	6 to 20 feet
2.	2 - 3 feet	2.	over 20 feet
3.	3 - 4 feet		
4.	> 4 feet		

Each size category is further divided into four type categories according to condition or status of the LWD as follows:

1. Dead and down (D/D)
2. Dead and standing (D/S)
3. Perched (on the bank and soon to be in the stream channel area)
4. Live:
 - a. coniferous;
 - b. deciduous

The range of coverage of this LWD inventory includes two distinct zones: 1) the "instream zone," defined as the stream channel within bankfull discharge demarcations; and 2) the "recruitment zone," defined as that area beyond the instream zone encompassing the floodplain

CALIFORNIA SALMONID STREAM HABITAT RESTORATION MANUAL

and an additional 50-foot wide strip measured uphill, along the slope from the outer edge of the floodplain. The recruitment zone, as defined for this LWD survey, represents about 70 percent of the LWD recruitment potential to the stream (McDade, et al., 1990; and Forest Ecosystem Management, 1993).

According to McDade et al. (1990), more than 70 percent of woody debris originates within 20 meters of the channel. He looked at the LWD recruitability of riparian vegetation as a function of distance from the stream. His study revealed that over 83 percent of the deciduous LWD and 53 percent of coniferous LWD originates within 10 meters of the stream channel. All hardwood LWD was delivered from within 25 meters, and only 13 percent of the conifers had a source distance greater than 25 meters. Also of interest, there was no significant difference ($P>0.05$) between source distance on steep and gentle side slopes, nor between source distance and stream order.

Andrus et al. (1993) studied recruitment rates based on modeling results of different riparian protection zones and stream sizes over time periods of up to 200 years to simulate long-term recruitment potential for LWD. There was a significantly greater percentage of pieces that should move toward the stream on steep slopes than on gentle slopes. For this reason we defined a "perched" condition category to describe pieces positioned for "imminent" delivery to the stream via near-stream landslides and stream bank failures common to the North Coast of California and generally along unstable or active stream channels.

LWD INVENTORY METHODOLOGY

The inventory includes equipment preparation, stream selection, access permission, stream channel typing, surveyor training, and the actual survey inventory.

Equipment list:

- Clinometer
- 7.5-minute USGS quadrangles of the stream
- Hip chain and refills
- Diameter tape, 50 feet
- LWD Inventory Forms and Stream Channel Type Work Sheets (Part III)
- Waders or hip boots
- Clipboard
- Optional:
 - 100-foot optical distance finder
 - Tree fork
 - *Timber Cruising Fieldbook* (Dilworth, 1981)

Stream selection

This methodology is best suited to first through third-order streams. If streams selected for LWD inventory have been previously stream channel typed, determine the limits and lengths of individual stream channel-type reaches to define LWD inventory reaches.

CALIFORNIA SALMONID STREAM HABITAT RESTORATION MANUAL

Training

Persons conducting the inventory must be familiar with stream channel typing methods, proper use of equipment listed above and recording forms presented below. Training in the field should include the following inventory procedure and daily sight calibration by each surveyor of LWD and live tree diameters and lengths.

At the beginning of each day, prior to categorizing and recording LWD, field personnel should select several pieces of LWD for sight calibration. Diameter ranges should be estimated and then verified by measuring with a diameter tape. Also, calibrate sight estimates of 6, 20, and 50 feet with length measurement verifications. Standing tree diameter is determined at breast height (54") above the ground measured from the upslope side of the tree. Diameter of downed logs is the largest diameter anywhere along the log.

Inventory Procedure

In general, the inventory is conducted by two people while walking in the stream channel, proceeding upstream. The LWD Inventory Form is designed so the stream bank entry columns must be oriented to the corresponding stream bank while facing upstream. Right and left banks are defined by convention as one looks downstream. When facing upstream the "right bank" is on the individual's left. One surveyor observes LWD, estimates sizes, and tallies LWD on one bank and LWD within the stream channel, while the other observer tallies the opposite bank. The second person can also estimate instream LWD if surveyor comparison is desired.

Recommended LWD inventory protocol requires that the stream first be stratified into reaches by stream channel types using Rosgen's methodology (Part III). Stream channel types may be determined from previous survey data, or surveyed prior to the LWD inventory. Be sure to attach copies of stream channel typing work sheets to the corresponding LWD Inventory Forms. Stream channel classification measurements within an area that is typical of the stream channel type must be determined. Avoid channel typing measurements near mouths of streams, within stream channel type transition areas, and near artificial or unusual features (e.g., bridges, slides, revetments).

Stream channel typing is important to determine start and stop distances of each stream channel type reach in order to calculate total length of each inventory reach. Begin numbering reaches with "1" as the reach nearest the stream mouth. As different stream channel types are encountered, number corresponding inventory reaches consecutively as the inventory proceeds upstream.

To begin the inventory, consider the stream segmented into 200-foot sections. Number the first six sections consecutively beginning with No. 1 as the downstream most 200-foot section. Next, toss a die to randomly select one of the first six 200-foot segments as Sample Area 1. This segment will become the first LWD inventory sample section in the stream. One LWD Inventory Form is required for each 200-foot sample section. After conducting the survey in this initial sample segment, proceed upstream 800 feet from the upper end of Sample Area 1 and inventory the next 200 feet as Sample Area 2. Sample Area 3 begins 800 feet upstream from the upper end of Sample Area 2, and so on. Stated another way, with the stream segmented into 200-foot sections, this procedure involves using a random start within the first six sections and then

CALIFORNIA SALMONID STREAM HABITAT RESTORATION MANUAL

systematically sampling every fifth 200-foot section. Continue the LWD inventory in this manner until the stream channel type changes. Be certain to note on the LWD Inventory Forms the distance measurements of where channel types change and a new inventory reach begins. When a new reach begins, the pattern of sampling every fifth 200-foot section can proceed uninterrupted (i.e., it is not necessary to repeat the random start procedure at each stream channel type change).

Beginning at the downstream end of the first 200-foot section, Sample Area 1, observe and tally, in the appropriate boxes on the LWD Inventory Form, all LWD pieces or live trees within the sample area with diameters ≥ 1 foot and lengths ≥ 6 feet, and root wads with a trunk diameter ≥ 1 foot.

During the survey in each 200-foot sample area, each of the surveyors will, periodically, ask the other to measure the diameter and length of the last estimated tree or LWD, and to measure the 50 foot estimated bank distance, and 6 and 20 foot tree length distances for accuracy and calibration purposes. Results of each measured estimate will be recorded on the calibration form. This ongoing calibration effort serves to keep the surveyors' estimates more accurate, and also provides the basis for analyzing the data for standard error.

To eliminate the problem of an insufficient number of samples that would represent LWD conditions in short streams or reaches, it is recommended that stream reaches less than 1,000 feet in length be surveyed throughout their entire length.

Downed large wood which is out of sight on terrace benches, usually has little chance of entering the stream. Therefore, if a piece of LWD cannot be observed from within the stream by a surveyor, it is not tallied. Also, well-rooted tree stumps located back on high bank terraces are not tallied because they have little or no potential for recruitment to the stream.

Root wads are differentiated from stumps in not being secure in the ground. Stumps are fully rooted in the ground and are at distances far enough from the stream that there is little or no potential of them being uprooted and entering the instream zone. Root wads have a high potential for reaching the stream channel. Root wads classified as dead/down are anchored in the ground by less than 25 percent of their root system, or are already "loose" and free to be moved, or are already in the channel. Root wads classified as dead/standing are anchored in the ground by at least 25 percent of their root system and have a good likelihood of being moved from the recruitment zone (bank) to the stream channel, or may already be in the stream channel. Root wads classified as "perched" are on the bank, and their movement into the stream channel is imminent. There is no classification for "live" root wads. If a root wad is sprouting, it is classified as a live tree and categorized based on diameter of the sprouting stem.

CALIFORNIA SALMONID STREAM HABITAT RESTORATION MANUAL

LWD INVENTORY FORM KEY

- 1) **Stream** - Stream name.
- 2) **Sample __ of __** - Indicate Sample No. of total 200-foot sample sections surveyed for each reach. Each sampled section is numbered consecutively proceeding upstream.
- 3) **Reach No.** - Number reaches consecutively beginning from the stream mouth. The reach number changes when the stream channel type changes (i.e., each reach is a distinct stream channel type).
- 4) **Date** - Date of survey (mm/dd/yy).
- 5) **Drainage** - River system.
- 6) **USGS Quad(s)** - Name(s) of 7.5-minute USGS topographic quadrangles.
- 7) **Reference Point** - Stream mouth or fixed landmark (bridge, tributary).
- 8) **Feet from Ref. Pt.** - Start: Distance from landmark at survey start.
Stop: Distance from landmark at survey end.
- 9) **Total Reach** - Total length in feet of inventoried reach, includes sampled and unsampled sections. Each reach is a distinct channel type.
- 10) **Latitude** - Latitude of stream confluence point.
- 11) **Longitude** - Longitude of stream confluence point.
- 12) **T__R__S__** - Township, range, and section of stream confluence.
- 13) **Surveyors** - Names of individuals conducting the inventory.
- 14) **Channel Characteristics** - Attach completed Stream Channel Type Work Sheet.
- 15) **Discharge Q** - Discharge in cfs at time of survey.
- 16) **Gradient** - Water surface slope in percent.
- 17) **Stream Channel Type** - From Stream Channel Type Work Sheet.
- 18) **Percent Substrate in Boulders** - Percent of the substrate in boulders in two size classes (does not = 100%). Size classes are 1-3 feet diameter, and greater than 3 feet diameter, measured at smallest diameter.
- 19) **Air Temp** - Air temperature in degrees Fahrenheit.
- 20) **Water Temp** - Water temperature in degrees Fahrenheit.

CALIFORNIA SALMONID STREAM HABITAT RESTORATION MANUAL

- 21) **Right Bank** - The stream's right bank, facing downstream, measured from bankfull discharge demarcation [bankfull width (W_{bkf})] to a point 50 feet upslope from the edge of the floodplain.
- 22) **Stream** - The channel area within bankfull width (W_{bkf}).
- 23) **Left Bank** - The stream's left bank, facing downstream, measured from bankfull discharge (Q_{bkf}) demarcation to a point 50 feet upslope from the edge of the floodplain.
- 24) **Slope** - Average percent slope of the right and/or left bank within the surveyed reach.
- 25) **Dom. Veg.** - The dominant live vegetation less than 1 foot in diameter within the entire survey reach is recorded by type and percentage: Code: 1 = Deciduous; 2 = Coniferous. The percent of the dominant type is noted as a decimal %. For example, an observation of deciduous vegetation estimated to compose 70% of the small (<1' diameter) vegetation should be recorded as: 1.70.
- 26) **D/D** - Number of dead and down pieces.
- 27) **D/S** - Number of dead and standing stems.
- 28) **Per** - Number of perched pieces for imminent delivery to stream.
- 29) **Live** - Number of live trees in two classes, coniferous and deciduous.
- 30) **Size Classes** - Range in upper part of box = diameter.
 Range in lower part of box = length.

Example: the first row is: 1 - 2d x 6 - 20, which indicates the diameter category of 1 - 2 feet and a length of 6 - 20 feet.
- 31) **Root** - Root wads are a separate size class. They must meet the minimum diameter at the base of the trunk but are not required to meet the minimum 6 feet length criteria.
- 32) **Comments** - Note indicators of old forest systems (i.e., large stumps). Note presence of fish restoration structures, and if they were tallied. Note suppressed trees if present. Include fish and wildlife observations. Use back side of form if needed.

LWD INVENTORY FORM

Stream: _____ Sample _____ of _____ Reach No. _____

Date ____/____/____ Drainage: _____ USGS Quad: _____

Reference Point: _____ Sample Length (Ft) _____

Reach Location (Feet From Ref.Pt) Start _____ Stop _____ Total _____

Lat ____ N Long ____ W (Reach start or Ref.Pt.) T ____ R ____ S ____

Surveyors: _____

CHANNEL CHARACTERISTICS (Attach Channel Typing Form)

Discharge Q _____ cfs Gradient _____ % Channel Type: _____

Percent Substrate in Boulders: (1'- 3') _____%; (>3') _____%

Air Temp _____ Water Temp _____

	Right Bank				Stream				Left Bank			
	% Slope _____ Dom. Veg. _____				Dom. Veg. _____				% Slope _____ Dom. Veg. _____			
	D/D	D/S	P e r	Live C D	Dead/ Down	D/S	Live C D	D/D	D/S	P e r	Live C D	
1-2d												
6-20												
Root												
1-2d												
>20'												
2-3d												
6-20												
Root												
2-3d												
>20'												
3-4d												
6-20												
Root												
3-4d												
>20'												
>4d												
6-20												
Root												
>4d												
>20'												

Note any LDAs (log jams), estimate size LxWxH and no. pieces. Note if gravel is retained upstream. Tally live conifer "C" and deciduous "D" trees separately. Tally root wads by diameter of "trunk". Include root wads <6' total length.

Comments:

ESTIMATE CALIBRATION FORM

Stream Name _____ Date _____

Surveyors _____

Reach No. _____

	Right Bank		Stream				Left Bank	
Sample	EST DIA.	TRUE DIA.	EST DIA.	TRUE DIA.	EST LENG.	TRUE LENG.	EST DIA.	TRUE DIA.
%								
Dis								

Reach No. _____

	Right Bank		Stream				Left Bank	
Sample	EST DIA.	TRUE DIA.	EST DIA.	TRUE DIA.	EST LENG.	TRUE LENG.	EST DIA.	TRUE DIA.
%								
Dis								

Calibration Form Key

- Stream Name:** Enter name of stream
- Date:** Enter date of survey (mm/dd/yy)
- Surveyors:** Enter name of persons conducting the survey
- Reach No.:** The number that corresponds with the Reach No. on the LWD Survey Form.
- Sample:** The number corresponding with the Sample No. on the LWD Survey Form.
- EST DIA.:** Enter the estimated diameter.
- TRUE DIA.:** Enter the measured diameter.
- EST LENG.:** Enter the estimated length.
- TRUE LENG.:** Enter the measured length.
- %** Enter the average percent difference between estimate and true.
- Dist.:** Enter the 50-foot distance estimate and measurement.

CALIFORNIA SALMONID STREAM HABITAT RESTORATION MANUAL

REFERENCES

- Andrus, C., B. Bilby, S. Gregory, T. Nicholson, A. McKee, and J. Boechler. 1993. Modeling woody debris inputs and outputs. Unpublished, Oregon Department of Forestry.
- Bilby, R.E. and J.W. Ward. 1989. Changes in characteristics and function of woody debris with increasing size of streams in Western Washington. *Transactions of the American Fisheries Society*, 118:368-378.
- Bilby, R.E. 1984. Post-logging removal of woody debris affects stream channel stability. *Journal of Forestry* 82:609-613.
- Bisson, P.A., J.L. Nielsen, R.A. Palmson, and L.E. Grove. 1982. A system of naming habitat types in small streams with examples of habitat utilization by salmonids during low stream flow. Symposium on acquisition and utilization of aquatic habitat inventory information. Western Division, American Fisheries Society. Bethesda, Maryland.
- Bisson, P.A., and eight others. 1987. Large woody debris in forested streams in the Pacific Northwest: past, present, and future. Pages 143-190 in E.O. Salo and T.W. Cundy (eds.), *Streamside Management: Forestry and Fishery Interactions*. Institute of Forest Resources, Contribution No. 57. University of Washington, Seattle.
- Decker, L., K. Overton, et.al. 1985. Habitat classification and inventory in northern California. Cooperative Habitat Evaluation Studies, USFS/DFG, unpublished, Eureka California.
- Dilworth, J.R. and John Bell. 1981. Log scaling and timber cruising. Oregon State University.
- Forest Ecosystem Management: An Ecological, Economic and Social Assessment. Report of the Forest Ecosystem Management Assessment Team. 1993. This is the President's "Option Nine Plan".
- Harrelsoe, C.C., C.L. Rawlins, and J. P. Potyondy. 1994. Stream channel reference sites: an illustrated guide to field technique. USDA Forest Service, General Technical Report RM-245.
- Likens, G.E. and R.E. Bilby. 1982. Development, maintenance and role of organic debris dams in New England streams. Pages 122-128 in F.J. Swanson (ed.) *Sediment budgets and routing in forested drainage basins*. U.S. Forest Service Research Paper PNW-141.
- McDade, M.H., F.J. Swanson, W.A. McKee, J.F. Franklin, and J. VanSickle. 1990. Source distance for coarse woody debris entering small streams in western Oregon and Washington. *Canadian Journal of Forestry Resources* 20:326-330.
- Platts, W.S., D. Amour, G.D. Booth, M. Gryant, J.L. Bufford, P. Culpin, S. Jensen, G.W. Lienkaemper, G.W. Minshall, S.B. Monsen, R.L. Nelson, J.R. Sedell, and J.S. Tuhy. 1987. *Methods for Evaluating Riparian Habitats with Applications to Management*. U.S. Dept of Agriculture, Forest Service, Intermountain Research Station, General Technical Report INT-221.

CALIFORNIA SALMONID STREAM HABITAT RESTORATION MANUAL

- Rainville R.P., S.C. Rainville, and E.L. Lider. 1985. Riparian silviculture strategies for fish habitat emphasis. Pages 186-189 in *Silviculture for Wildlife and Fish: A Time for Leadership*. Proceedings, 1985 Wildlife and Fish Ecology Working Group. Society of American Foresters. Bethesda, MD.
- Reeves, G.H., F.H. Everest, and J.R. Sedell. 1993. Diversity of juvenile anadromous salmonid assemblages in coastal Oregon basins with different levels of timber harvest. *Transactions of the American Fisheries Society* 122:309-317.
- Rosgen, D.L. 1994. A classification of natural rivers. *Catena*, Vol 22: 169-199, Elsevier Science, B.V. Amsterdam.
- Rosgen, D.L. 1996. *Applied river morphology*. Printed Media Companies, Minneapolis, Minnesota.
- Rosgen, D.L. and B.L. Fittante. 1986. Fish habitat structures: a selection guide using stream classification. Pages 163-179 in J. G. Miller, J. A. Arway and R. F. Carline, eds. *The 5th trout stream habitat improvement workshop*.
- Sedell, J.R., P.A. Bisson, S.J. Swanson, and S.V. Gregory. 1988. *From the forest to the sea; a story of fallen trees*. USDA Forest Service, Gen. Tech. Report PNW-GTR-229.
- Sedell, J.R., F.J. Swanson, and S.V. Gregory. 1984. Evaluating fish response to woody debris. Pages 222-245 in *Proceedings of the Pacific Northwest Stream Habitat Management Workshop*. California Cooperative Fishery Research Unit, Humboldt State Univ. Arcata, CA.
- Sullivan, K. 1988. *Hydraulics and fish habitat in relation to channel morphology*. Doctoral dissertation. Johns Hopkins University. Maryland.
- Trush, W.J. 1989. *The influence of channel morphology and hydrology on spawning populations of steelhead trout in South Fork Eel River tributaries*. Doctoral dissertation. University of California, Berkeley, CA.

CALIFORNIA SALMONID STREAM HABITAT RESTORATION MANUAL

PART IV

FISH SAMPLING METHODS

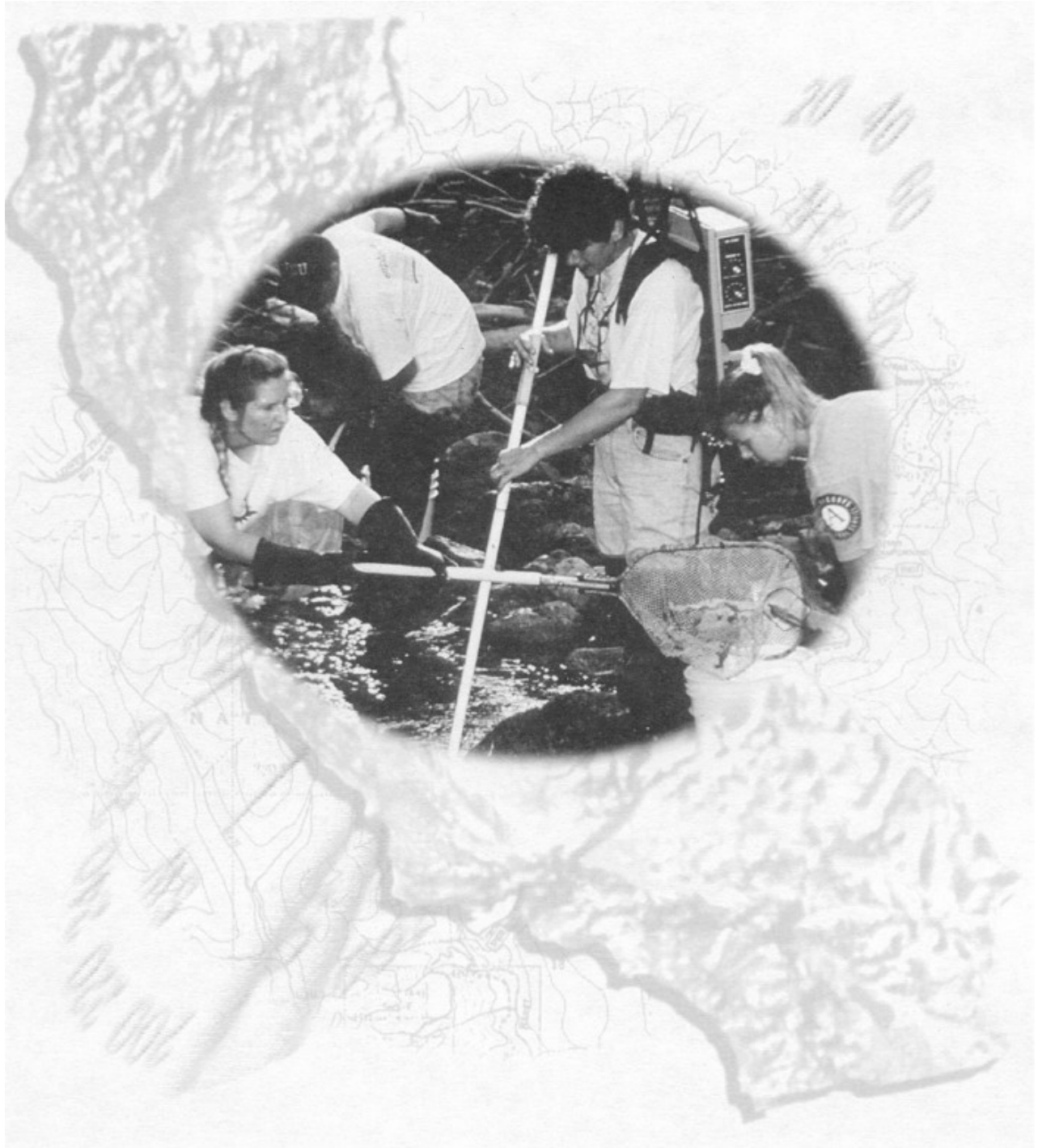

CALIFORNIA SALMONID STREAM HABITAT RESTORATION MANUAL

PART IV FISH SAMPLING METHODS

Assessment surveys of watershed and stream habitat must include descriptions of fish resources within the stream. The purpose of this section is to outline simple fish sampling techniques that will help to identify fish resources within a stream or watershed. Much of the necessary information may be available from DFG files or the district fishery biologist. In order to describe the fishery, the following data should be gathered:

- Species composition
- Juvenile rearing areas or general distribution
- Spawning areas or general distribution
- Sizes (lengths) of adults and juvenile
- Age classes of juveniles (based on lengths)
- Relative abundance in selected areas
- Biomass (weight per unit volume)
- Habitat utilization
- Timing of spawning activity
- Timing of juvenile emigration

This is considered "baseline" information that provides a general assessment of fish presence, distribution and habitat utilization within a stream. It is essential to know what fish species exist within a stream and particularly the status of "target" species. The upstream range of adult spawners and juveniles is important information for planning habitat enhancement work within a stream. Relative abundance of a species may suggest trends in past or future population numbers. Age classes of juveniles may indicate the quality of summer and winter nursery areas. The amount of habitat being utilized or not being utilized by adults and juveniles is useful information for determining habitat problems and potential solutions. It should be emphasized that absence of a species from a stream cannot conclusively be determined from any single sample of that stream.

Most general fishery information required for the level of habitat assessment described in this manual can be obtained using non-capture techniques. In some instances, specialized capture techniques of trapping or electrofishing may be useful to obtain length, weight, and positive species identification data. However, most fish capture methods, including trapping and electrofishing, have a high potential for causing fish mortality if used improperly. It is highly recommended that fish capture be avoided whenever possible, and that observation techniques be employed to collect the general fishery information required for the level of habitat assessment described in this manual.

Non-capture methods involve:

- Stream bank or above water observation
- Direct or underwater observation

Any fish sampling or fish data collection must be approved and coordinated with DFG biologists and with the knowledge of the local Fish and Game Warden. State and Federal collector's permits are necessary for any technique involving capture, handling, tagging, or removal of fish from a stream or lake.

CALIFORNIA SALMONID STREAM HABITAT RESTORATION MANUAL

The data collected by these methods are intended for useful descriptions of fish presence, relative abundance and habitat utilization in the context of planning restoration or enhancement projects. They are not intended to produce statistically based population estimates of adult spawners, juveniles, or smolt productivity. It is beyond the scope of this manual to discuss in detail all the uses of these techniques.

STREAM BANK OBSERVATION

Observation of fish from the stream bank or other vantage point is a commonly used technique to determine presence or absence of fish. It also provides "gross" estimates of fish numbers in sampled habitats (e.g., 10-20 young-of-year steelhead). This method can be accomplished quickly and the only equipment required are polarized glasses and record forms or notebook.

The primary drawback to bank observation is difficulty with species identification. Observation experience associated with species confirmation techniques (electrofishing or trapping) can improve species identification skills. Numbers of fish observed are very rough estimates of relative abundance in selected habitats or stream reaches and should be used with caution. However, this type of information has many uses in describing existing conditions and comparing observations over several years. Useful data stems from observer consistency and careful attention to accuracy.

Opportunities for observation are usually best in pools and runs where visibility is better than in riffles. Habitats to be observed should be approached slowly and quietly from downstream; most fish orient themselves heading upstream when feeding. Patience is required to adjust the observer's eyes to the light conditions and to allow the fish to recover from any fright response caused by the observer's approach.

Juvenile salmonids should be placed in general age categories according to length:

- 0+ young-of-year (YOY), 3 inches or less
- 1+ 3 to 6 inches
- 2+ 6 inches or greater

These lengths are approximate and depend on stream systems and time of year. Generally, these size categories are obvious when groups are observed together. In most cases, the smaller size group will be more numerous.

UNDERWATER OBSERVATION

This is a cost-effective method to determine fish distribution and species composition. Underwater observation can be economically applied on a larger scale than electrofishing. Use of this method permits close observation of fish behavior and habitat utilization. Experienced divers can learn to identify, count, and record fish in a relatively short time. The effectiveness of this method can be improved when combined with electrofishing to calibrate the diver's observations.

CALIFORNIA SALMONID STREAM HABITAT RESTORATION MANUAL

One or more divers, equipped with a mask, snorkel, and wet or dry suit, enter a habitat unit at the downstream end and swim or crawl to the upstream end, counting, identifying, and recording all the fish they see. In small streams or habitat units, a single, experienced diver can effectively count and identify all fish in a single pass. In larger streams or complex habitat units, a combination of divers working together systematically may be necessary to determine fish numbers. Since it is difficult to dive and count fish in riffles, underwater observation is usually only conducted on sample pool and run units.

Tools and Supplies Needed

- Wet or dry suit
- Fins or wading boots
- Snorkel
- Plastic slate board
- Mask
- Waterproof felt pen

Instructions for Completing the Stream Bank or Underwater Observation Field Form

- 1) **Form No.** - Enter in the form number. Number the forms sequentially beginning with "01" on the first page and "02" on the second page and so on.
- 2) **Date** - Enter the day's date: mm/dd/yy.
- 3) **Stream Name** - Enter the name of the stream.
- 4) **T-R-S** - Enter the township, range, and section at the mouth of the stream.
- 5) **Drainage** - Enter the name of the drainage.
- 6) **Lat** - Record the latitude of the stream at the confluence taken from the 7.5-minute USGS quadrangle.
- 7) **Long** - Record the longitude of the stream at the confluence determined from the 7.5-minute USGS quadrangle.
- 8) **Quad** - Record the name of the 7.5-minute USGS quadrangle on which the confluence of the stream is located.
- 9) **Observer(s)** - Enter the names of the observers.
- 10) **Time** - Enter the time the survey began in military time (24-hour clock).
- 11) **Air Temperature** - Enter the air temperature to the nearest degree Fahrenheit.
- 12) **Water Temperature** - Enter the water temperature to the nearest degree Fahrenheit.

**CALIFORNIA SALMONID STREAM
HABITAT RESTORATION MANUAL**

- 13) **Reach No.** - Record the sequential number of the stream reach being sampled. This reach number should be the same as the reach number on the Habitat Inventory Data Form (Part III- Habitat Inventory Data Form), which is based on sequential changes in channel type.
- 14) **Habitat Unit No.** - Record the habitat unit number from the Habitat Inventory Data Form.
- 15) **Habitat Type** - Enter the number or abbreviation for the individual habitat type being sampled. The number/abbreviation should correspond to the Habitat Unit Type on the Habitat Inventory Data Form.
- 16) **Reference Point** - Stream confluence, a tributary, a road crossing, or any other permanent feature identified on the 7.5-minute USGS quadrangle.
- 17) **Distance from the Confluence or other Known Location** - Enter the distance in feet from the reference point.
- 18) **Length of Stream Sampled in Feet** - Enter the length of stream sampled in feet.
- 19) **Observation Method** - Put a check by the sampling method used in the survey.
- 20) **Species/Size Class/Numbers** - Enter the species, size class, and numbers sampled or observed.
- 21) **Comments** - Enter any comments regarding the above observations.

STREAM BANK OR UNDERWATER OBSERVATION FIELD FORM

Form No. _____ of _____ Date ____/____/____

Stream Name _____ T ____ R ____ S ____

Drainage _____

Lat: _____ Long: _____ Quad: _____

Observer(s) _____

Time _____ Air Temperature _____ Water Temperature _____

Reach No. _____ Habitat Unit No. _____ Habitat Type _____

Reference Point _____

Distance from the confluence or other reference point _____

Length of stream sampled in feet _____

Observation Method: _____ Stream Bank _____ Underwater

Species	Size Class	Numbers	Species	Size Class	Numbers

Comments _____

CALIFORNIA SALMONID STREAM HABITAT RESTORATION MANUAL

SALMON SPAWNER SURVEYS

Salmon spawner surveys (also called salmon carcass surveys) are stream bank or above-water surveys. Surveyors usually walk along the stream bank and enter the number of spawned salmon carcasses, redds, and live adults observed. This information is useful to:

- Determine if adults are returning to and spawning within a stream reach or basin area;
- Determine which species or races are utilizing the sample area;
- Determine relative abundance and distribution of carcasses, redds or live fish within a sample area;
- Recover and enter marked fish for mark studies;
- Identify preferred spawning habitat area.

Stream flow conditions can alter the timing and distribution of spawning activity within a single season and also from one year to the next. For annual comparison of data it is recommended that weekly surveys be conducted throughout the entire potential time range of spawning activity. Descriptions of spawning distribution within a basin should not rely on carcass counts conducted only during the assumed week of peak spawning. Spawner distribution within a stream system may be different for early versus late spawners.

The typical method for conducting spawner surveys is to walk along the stream bank or wade in the stream counting and entering all carcasses, redds and live fish observed. Carcasses are examined to determine species, sex, and/or missing fins. The fork lengths (FL) of fish are measured from the tip of the snout to middle of the tail to the nearest centimeter (cm). Counted carcasses are either cut in half or marked with a hog ring to eliminate being counted in subsequent surveys. With prior DFG approval, the heads of carcasses with missing adipose (Ad) fins will be removed and retained for coded-wire-tag (CWT) extraction by DFG. All data is entered on the Daily Salmon Spawning Stock Survey Field Form as indicated below.

Tools and Supplies Needed

- Thermometer
- Gaff hook, handle marked in centimeters
- Waders with non-slip soles
- Pencils
- Waterproof field enter form
- Waterproof ID tags for fish heads (Figure IV-1)
- Plastic "Ziploc" bags for fish heads
- Machete and file or hog-ring pliers and hog rings

CALIFORNIA SALMONID STREAM HABITAT RESTORATION MANUAL

- Vest or day pack
- Polarized glasses
- Stream map to indicate location of spawning activity
- Drinking water and food

Instructions for Completing the Daily Salmon Spawning Stock Survey Field Form

- 1) **Stream** - Enter the stream name.
- 2) **T-R-S** - Enter the township, range, and section from the USGS quadrangle.
- 3) **Lat** - Latitude of the confluence of the stream determined from a 7.5-minute USGS quadrangle.
- 4) **Long** - Longitude of the confluence of the stream determined from a 7.5-minute USGS quadrangle.
- 5) **Quad** - Name of the USGS 7.5-minute quadrangle containing the confluence of the stream.
- 6) **Drainage** - Enter the drainage name.
- 7) **County** - Enter the county in which the stream is located.
- 8) **Starting Location** - Enter the starting point of the survey reach; for example, the confluence with another stream, a highway mileage marker, a bridge, etc.
- 9) **Lat and Long of the Starting Location** - Enter the latitude and longitude of the starting point of the survey reach taken from a 7.5-minute USGS quadrangle.
- 10) **Ending Location** - Enter the ending point of the survey reach; for example, the confluence with another stream, a highway mileage marker, a bridge, etc.
- 11) **Lat and Long of the Ending Location** - Enter the latitude and longitude of the ending point of the survey reach taken from the 7.5-minute USGS quadrangle.
- 12) **Feet/Miles Surveyed** - Determine the distance of the survey using a map measurement device and a 7.5-minute USGS quadrangle. If the distance surveyed was measured using a hip chain enter the distance in feet.
- 13) **Date of Survey** - Enter the day's date: mm/dd/yy.
- 14) **Weather** - Make a check mark to indicate weather conditions: clear, overcast, rain. If weather conditions change during the survey, note this in the remarks section at the end of the page.

CALIFORNIA SALMONID STREAM HABITAT RESTORATION MANUAL

- 15) **Water Clarity** - Estimate water clarity (0-2 ft, 2-4 ft, or >4 ft) at the beginning of the survey. If water clarity changes during the survey, note this in the remarks section at the end of the page.
- 16) **Water Temperature** - Water temperature is to be taken in degrees Fahrenheit at the beginning of the survey.
- 17) **Air Temperature** - Air temperature is to be taken in degrees Fahrenheit at the beginning of the survey.
- 18) **Time** - Enter the time when temperatures were taken.
- 19) **Crew** - Enter the names of the persons doing the survey.
- 20) **Number of Live Fish Observed** - Enter the number of live chinook adults, chinook jacks (<55 cm FL), coho, and steelhead observed. Identification of live fish can be very difficult. If positive identification is not possible, enter the fish as an unknown.
- 21) **Number of Carcasses Examined** - Identify all carcasses to species and sex. Measure fork length in centimeters and enter on the form. Examine all carcasses for adipose fin clips or any other fin clip. Mark all the carcasses using hog rings or cut carcasses in half after examination.
- 22) **Tag Number of Adipose-Clipped Fish and Snout Recoveries** - All carcasses must be examined for adipose fin clips. If the adipose fin is missing, the carcass may contain a CWT and the snout must be cut off and retained. Remove the snout by cutting across the head in the vicinity of the eyes; cut straight down from the eyes through the upper jaw and into the mouth cavity. Remove the snout in one piece. If unsure of the removal procedure, take the entire head. It is important not to lose the tag due to an improper cut. The project name, the recovery location, the species, length and sex of the fish, date and other relevant information must be entered on a tag and wired to the snout. The project name will be entered on the tag for later reference (Figure IV-1). The snout or head must be frozen in a zip-lock bag and taken to DFG where the coded-wire tags will be excised and decoded. Snouts must be individually bagged.
- 23) **Other Fin Clips Observed** - Enter any fin clips observed other than adipose fins.
- 24) **Number of Skeletons Observed** - Any fish that cannot be measured, or any identifiable parts of fish found are considered skeletons. If it is possible to identify the species, enter it appropriately; if not, enter it as unknown.
- 25) **Number of Redds Observed** - Enter the number and location of observed redds. This can be difficult in areas of heavy spawning due to multiple redds and super-imposition of redds.
- 26) **Remarks** - Add any information discovered during the survey such as barriers, landslides, etc. Include any information necessary to clarify other entries on the field form.

**CALIFORNIA SALMONID STREAM
HABITAT RESTORATION MANUAL**

PENCIL	ONLY		
No. N ^o	105614		
Project	_____		
location	_____		
species	K	S	SH
race	fall	spr	
f_ _cm	<input type="checkbox"/>	<input type="checkbox"/>	<input type="checkbox"/>
sex	M	F	
recovery	hat		trp
method	crl	car	nrr
date	m m	d d	y y
binary	<input type="checkbox"/> <input type="checkbox"/> <input type="checkbox"/>		
code	<input type="checkbox"/> <input type="checkbox"/> <input type="checkbox"/>		
	A	D1	D2

Figure IV-1. Coded-wire-tag recovery form.

DAILY SALMON SPAWNING STOCK SURVEY FIELD FORM

Stream: _____ T _____ R _____ S _____
 Lat: _____ Long: _____ Quad: _____
 Drainage: _____ County: _____
 Starting location: _____ Lat: _____ Long: _____
 Ending location: _____ Lat: _____ Long: _____
 Feet/miles surveyed: _____
 Date of survey: ____/____/____ Weather: Clear _____ Overcast _____ Rain _____
 Water clarity: 0-2 ft. _____ 2-4 ft. _____ >4 ft. _____
 Water temp: _____ Air temp: _____ Time: _____
 Crew: _____

Number of live fish observed: Chinook adults _____ Chinook grilse _____ Coho _____
 Steelhead _____ Unknown _____

Number carcasses examined:

<u>Chinook</u>		<u>Coho</u>	
Male (FL)	Female (FL)	Male (FL)	Female (FL)
_____	_____	_____	_____
_____	_____	_____	_____
_____	_____	_____	_____
_____	_____	_____	_____
_____	_____	_____	_____
_____	_____	_____	_____
_____	_____	_____	_____
_____	_____	_____	_____
_____	_____	_____	_____
_____	_____	_____	_____
_____	_____	_____	_____
_____	_____	_____	_____
_____	_____	_____	_____
_____	_____	_____	_____
_____	_____	_____	_____
_____	_____	_____	_____
_____	_____	_____	_____
_____	_____	_____	_____
_____	_____	_____	_____
_____	_____	_____	_____
_____	_____	_____	_____

Tag number of adipose clipped fish and snout recoveries:

Other fin clips observed: _____

Number of skeletons observed:
 Chinook _____ Coho _____ Steelhead _____ Unknown _____

Number of redds observed: _____

Comments:

CALIFORNIA SALMONID STREAM HABITAT RESTORATION MANUAL

ELECTROFISHING

Electrofishing is a fish capture technique that involves momentarily stunning fish with an electric current and quickly netting them before they recover. It is a useful capture technique when fish must be closely examined in hand. However, electrofishing can quickly kill fish if water temperatures are too high, if fish remain in the electric field too long, or if the electric charge is too powerful.

Electrofishing can cause personal injury. Electrofisher operators and crews must be trained in safety procedures and be knowledgeable about stream conditions, electrical theory, and fish physiology to prevent injury to themselves and to fish. References regarding electrofishing equipment, procedures, safety, and sampling methods are presented at the end of this section. All fish capture techniques and sampling methods must be approved and coordinated by California Department of Fish and Game personnel.

Electrofishing used during habitat inventory methods outlined in this manual is generally used to describe species composition and distribution within a stream. The single-pass method is most commonly used for these data. All fish captured are identified to species and then counted and returned to the stream. Amphibians and reptiles captured are identified and entered. The Electrofishing Field Form is used to enter this information.

In some cases, estimates of the relative abundance fish populations within a sample site may be necessary for baseline data, project evaluation, or long-term monitoring purposes. Population estimates can be determined with a standard multi-pass depletion method. For multi-pass sampling use the Electrofishing Field Form and the Electrofishing Field Form Supplemental Page for data recording.

Instructions for Completing the Electrofishing Field Form

- 1) **Form No.** - Enter the form number. Number the forms sequentially beginning with "01" on the first page, "02" on the second page, and so on.
- 2) **Date** - Enter the day's date: mm/dd/yy.
- 3) **Stream Name** - Enter the stream name.
- 4) **Site Number** - Enter the sample site number. Number the sample sites sequentially beginning at the most downstream location.
- 5) **Drainage** - Enter the drainage name.
- 6) **T-R-S** - Enter the township, range, and section at the mouth of the stream.
- 7) **PNMCD** - Enter the official numeric code for the stream name according to the reach file list.

CALIFORNIA SALMONID STREAM HABITAT RESTORATION MANUAL

- 8) **Lat and Long** - Latitude and longitude of the confluence of the stream determined from a 7.5-minute USGS quadrangle.
- 9) **Quad** - Enter the name of the USGS 7.5-minute quadrangle on which the confluence of the stream appears.
- 10) **Distance from Confluence** - Enter the distance from the confluence to the downstream end of the sample site.
- 11) **Reach Number** - Enter the sequential number of the stream reach being sampled. This reach number should be the same as the reach number on the Habitat Inventory Data Form.
- 12) **Channel Type** - Enter the channel type of the stream reach being sampled. This designation should be available on the Habitat Inventory Data Form.
- 13) **Reference Point** - Stream confluence, a tributary, a road crossing, or any other permanent feature identified on the 7.5-minute USGS quadrangle.
- 14) **Distance from RP** - Enter the distance in feet from the reference point to the downstream end of the sample site. Indicate upstream or downstream from the RP.
- 15) **Personnel** - Enter the name of the person(s) performing the following sampling functions:
 - E-Fish - operating the electrofisher
 - Netting - netting stunned fish and transferring to holding buckets
 - Measurements - handling fish for identification, length, and weight
 - Recorded - writing the information on the field form
- 16) **Habitat Unit Numbers** - When applicable, enter each habitat unit number from the Habitat Inventory Data Form which lies within the sample site being electrofished. If a Habitat Inventory Data Form does not exist for the same season, leave blank.
- 17) **Habitat Unit Types** - Enter the number or abbreviation for each individual habitat type being electrofished within the sample site. When available, the number/abbreviation should correspond to the habitat unit type on the Habitat Inventory Data Form.
- 18) **Mean Length** - Enter the mean length of each habitat type within the site sampled. This information may be available from the Habitat Inventory Data Form.
- 19) **Mean Width** - Enter the mean width of each habitat type within the site sampled. This information may be available from the Habitat Inventory Data Form.
- 20) **Mean Depth** - Enter the mean depth of each habitat type within the site sampled. This information may be available from the Habitat Inventory Data Form.

CALIFORNIA SALMONID STREAM HABITAT RESTORATION MANUAL

- 21) **Time** - Enter the start and stop time, in military time (24-hour clock), of the electrofishing pass through the sample site.
- 22) **H₂O E** - Enter the water temperature, to the nearest degree Fahrenheit, at the beginning and end of the electrofishing pass through the sample site.
- 23) **Air E** - Enter the air temperature, to the nearest degree Fahrenheit, at the beginning and end of the electrofishing pass through the sample site.
- 24) **Conductivity** - Enter the ambient conductivity (i.e., conductivity at existing water temperature) in micro Siemens/cm ($\mu\text{S}/\text{cm}$), measured at the same time and location as the start water temperature for Pass #1.

Some meters measure ambient conductivity; check owners manual or call manufacturer. Most meters measure specific conductivity (i.e., conductivity adjusted to a reference temperature, usually 25EC; refer to owners manual). Specific conductivity can be converted to ambient conductivity by the following formula:

$$\sigma_a = \sigma_s / [1.02^{(T_s - T_a)}]$$

where: σ_a and T_a = ambient conductivity and temperature (EC)

σ_s and T_s = specific conductivity and temperature (EC)

- 25) **Flow** - Enter the flow as measured using a flow meter.
- 26) **Pass #** - Enter the pass number. More than one pass is usually necessary only when electrofishing in developing a population estimate.
- 27) **Effort** - Enter the effort from the time counter, in seconds, on the electrofisher for each pass (P_i). If more than one electrofisher is used, sum their individual efforts and enter the Total Effort for the pass (E_i).
- 28) **Freq.** - Enter the frequency (Hz) setting selected on the electrofisher for each pass.
- 29) **Output Voltage** - Enter the output voltage (volts) setting selected on the electrofisher for each pass.
- 30) **Species** - Enter the species of fish sampled. Start a new line for each new species.
- 31) **Fork Length** - Enter the length of each fish in millimeters from the tip of the snout to fork of the tail.

CALIFORNIA SALMONID STREAM HABITAT RESTORATION MANUAL

Summary Data:

- 32) **Species** - Enter the species of fish sampled. Start a new line for each new species.
- 33) **Catch** - Enter the total number of fish captures for each species sampled.
- 34) **Weight** - Enter the total weight in grams of each species. Weight data is optional.
- 35) **Mortalities** - Enter the number of dead fish of each species resulting from the shocking and handling operations for each pass.
- 36) **Comments** - Enter any comments.

Note: If electrofishing for a population estimate, enter information for each subsequent pass on the Electrofishing Field Form Supplemental Page.

The following formula (also provided in the Comment sections on the Electrofishing Field Form Supplemental Page) can be used to calculate the depletion percentage from the previous pass. This information can be helpful in a field protocol determining if a subsequent pass is required:

$$(1 - [(N_{i+1} * E_i) / (N_i * E_{i+1})]) * 100 = \text{Pass Depletion}$$

where: N_i and E_i = number of fish of a given species captured and total number of seconds shocked on the previous pass, and N_{i+1} and E_{i+1} = number of fish of a given species captured and total number of seconds shocked on the current pass.

**ELECTROFISHING FIELD FORM
SUPPLEMENTAL PAGE**

Form # _____ of _____

Date ___/___/___ Stream Name _____ Site # ___ Drainage _____ Pass # _____

Start Time _____ **End Time** _____ **Start Water Temp** _____ **End Water Temp** _____

Start Air Temp _____ **End Air Temp** _____

Effort(s) _____ + _____ = **Total Effort (E₂)** _____ (seconds) Freq. _____ (Hz) Output Voltage _____

Species

Fork Length (mm)

Summary: Species _____ Catch _____ Wt. _____ Mortalities _____;
 Species _____ Catch _____ Wt. _____ Mortalities _____;
 Species _____ Catch _____ Wt. _____ Mortalities _____;
 Species _____ Catch _____ Wt. _____ Mortalities _____;

Comments:

$$(1 - [(N_2 * E_1) / (N_1 * E_2)]) * 100 = \text{Pass Depletion}$$

$$(1 - [(\quad * \quad) / (\quad * \quad)]) * 100 = \quad \text{Pass \#2 Depletion}$$

Site # _____ Pass # _____

Start Time _____ **End Time** _____ **Start Water Temp** _____ **End Water Temp** _____

Start Air Temp _____ **End Air Temp** _____

Effort(s) _____ + _____ = **Total Effort (E₂)** _____ (seconds) Freq. _____ (Hz) Output Voltage _____

Species

Fork Length (mm)

Summary: Species _____ Catch _____ Wt. _____ Mortalities _____;
 Species _____ Catch _____ Wt. _____ Mortalities _____;
 Species _____ Catch _____ Wt. _____ Mortalities _____;
 Species _____ Catch _____ Wt. _____ Mortalities _____;

Comments:

$$(1 - [(N_3 * E_2) / (N_2 * E_3)]) * 100 = \text{Pass Depletion}$$

$$(1 - [(\quad * \quad) / (\quad * \quad)]) * 100 = \quad \text{Pass \#3 Depletion}$$

CALIFORNIA SALMONID STREAM HABITAT RESTORATION MANUAL

REFERENCES

- California Department of Fish and Game, Fish and Game Operations Manual, Volume II, Section 12851.
- Cross, D.G. and B. Stott. 1975. The effect of electrical fishing on the subsequent capture of fish. *J. Fish. Biol.* 7:349-357.
- Friedman, R. 1974. Electrofishing for population sampling: A selected bibliography. U.S. Dept. of Interior. Office of Library Services, Bibliography series 31.
- Pratt, V.S. 1954. Fish mortality caused by electrical shockers. *Trans. Amer. Fish. Soc.* 84:93-96.
- Reynolds, J.B. 1983. Electrofishing. Pages 147-163 in L.A. Nielsen and D.L. Johnson, editors. *Fisheries Techniques*. American Fisheries Society, Bethesda, Maryland.
- Schreck, C.B., R.A. Whaley, M.L. Bass, O.E. Maughan, and M. Solazzi. 1976. Physiological responses of rainbow trout (*Salmo gairdneri*) to electroshock. *J. Fish. Res. Bd. Canada.* 33 (1):76-84.

CALIFORNIA SALMONID STREAM
HABITAT RESTORATION MANUAL

PART V

WORKING WITH THE DATA

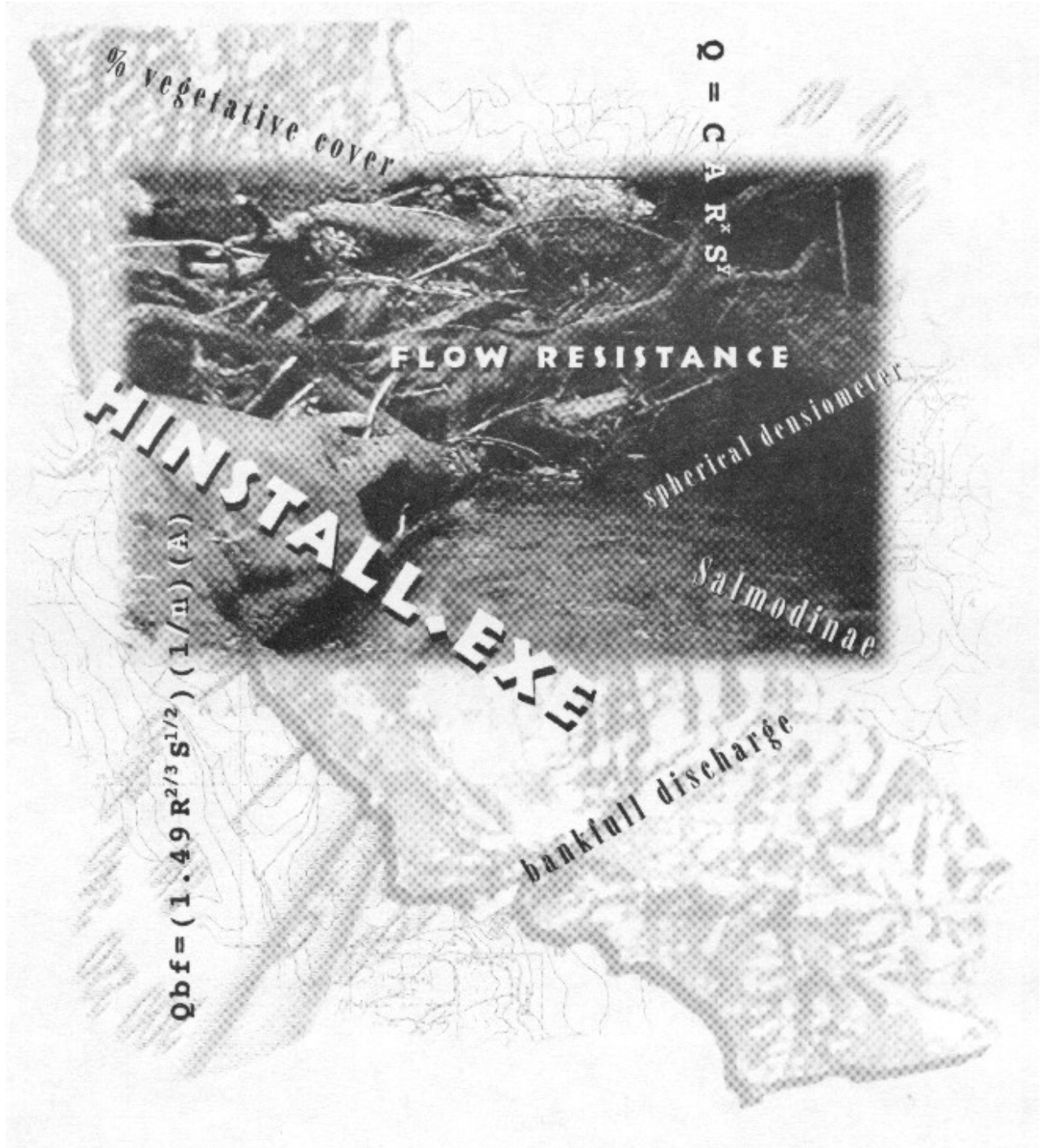

CALIFORNIA SALMONID STREAM HABITAT RESTORATION MANUAL

PART V WORKING WITH THE DATA

A stream habitat inventory using the methodology presented in Part III will generate a formidable stack of data forms. The task of reducing this stack of paper to a manageable series of summaries can be facilitated with the help of a computer. Development of fish habitat improvement recommendations from this information requires the expertise of a qualified fishery specialist with appropriate field experience. To facilitate management of all this material, the Department of Fish and Game Inland Fisheries Division has developed two digital tools. The first is a DOS based program for entering, summarizing and analyzing data known as "HABITAT"; the second tool is a Geographic Information System (GIS) for viewing and mapping the habitat data. DFG also has standardized stream report formats for presenting the findings and results of the surveys. The HABITAT program, GIS format, and stream report format are discussed in this section. More detailed information on these programs and their operations can be found in Appendix I.

DATA ENTRY

Computer data entry from field forms can be a tedious, time consuming process that is fraught with chances for introducing errors. Adoption of a system for maintaining integrity of data during entry operations is imperative for production of high quality reports and recommendations.

For collection of field data, DFG recommends the data forms presented in Part III of this manual, which have been extensively field tested, be reproduced on waterproof paper. The resulting forms will be very durable and can be used under field conditions with a minimum of special training. The data on the forms can be efficiently entered into database files in the office using the HABITAT program. The forms should be archived and will serve as a valuable, permanent backup to computer files and provide vital quality control as needed.

DFG has adopted the dBASE database system. Data entry in dBASE (.dbf) files can be accomplished using commercially available dBASE, version IV or newer, programs, or using various other programs that can convert the data into dBASE files, or using the HABITAT program.

The computerized data should be quality checked after being entered. Several quality control/quality assurance methods can be used. A complete entry-by-entry visual check of the database file against the original forms is time consuming, but effective. A partial check of randomly selected entries does not correct all errors but does provide a measure of data quality control accuracy. A commercial data entry service that uses a double-entry data keying program is another effective method of reducing error. The HABITAT program contains a File Check program to detect several common errors.

Another way of reducing entry errors is by having the field personnel enter the data, as they collect it, directly into a special waterproof field computer. This procedure eliminates the need for paper forms and later data entry, which can save time and reduce the chance for transcription errors. However, there are several possible problems. A large investment is required in equipment, computer program development and personnel training. In addition, there are increased possibilities for data loss through mechanical and electrical equipment failure. Further, if a data entry error occurs in the field during electronic data entry, there is no way to detect that an

CALIFORNIA SALMONID STREAM HABITAT RESTORATION MANUAL

error has occurred, which could affect the balance of the survey as well as the particular erroneous sample.

DATA SUMMARY AND ANALYSIS

Once the data has been entered and checked for errors, the process of summarizing is routine using the HABITAT program. Analysis of data summaries, however, is a job for experienced fish habitat specialists.

Data Summary

The HABITAT program provides a fully automated fish habitat inventory data summary. Examples of summarized data are presented below in Tables 1 through 10. A wide variety of computer programs and manual methods can be used for creating custom data summaries, tables and graphs. Data presentation in graphical form as illustrated below in Graphs 1 through 4 may be useful in illustrating specific points. Graphics can be easily created using computer graphics programs and the spreadsheet files the HABITAT program produces.

CALIFORNIA SALMONID STREAM HABITAT RESTORATION MANUAL

Table V-1. Summary of riffle, flatwater, and pool habitat types. Summarizes Level II riffle flatwater, and pool habitat types.

JUGHANDLE CREEK														
Drainage: PACIFIC OCEAN														
Table 1 - SUMMARY OF RIFFLE, FLATWATER, AND POOL HABITAT TYPES														
Survey Dates: 10/28/96 to 10/30/96														
Confluence Location: QUAD: FORT BRAGG LEGAL DESCRIPTION:														
LATITUDE:39°22'37" LONGITUDE:123°48'55"														
HABITAT	UNITS	HABITAT	HABITAT	MEAN	TOTAL	PERCENT	MEAN	MEAN	MEAN	ESTIMATED	MEAN	ESTIMATED	MEAN	MEAN
UNITS	FULLY	TYPE	PERCENT	LENGTH	LENGTH	TOTAL	WIDTH	DEPTH	AREA	TOTAL	VOLUME	TOTAL	RESIDUAL	SHELTER
	MEASURED		OCCURRENCE	(ft.)	(ft.)	LENGTH	(ft.)	(ft.)	(sq.ft.)	AREA	(cu.ft.)	VOLUME	POOL VOL	RATING
										(sq.ft.)	(cu.ft.)	(cu.ft.)		
103	13	RIFFLE	31	18	1900	22	5.5	0.2	114	11762	35	3573	0	12
97	10	FLATWATER	29	39	3819	44	6.6	0.4	171	16560	61	5878	0	32
127	23	POOL	38	22	2761	32	7.7	0.8	169	21409	153	19471	118	37
5	0	DRY	2	15	74	1	0.0	0.0	0	0	0	0	0	0
1	0	CULVERT	0	38	38	0	0.0	0.0	0	0	0	0	0	0
TOTAL	TOTAL			TOTAL	TOTAL				TOTAL	TOTAL	TOTAL	TOTAL		
UNITS	UNITS			(ft.)	(ft.)				(sq. ft.)	(sq. ft.)	(cu. ft.)	(cu. ft.)		
333	46			8592					49731		28921			

JUGHANDLE CREEK

HABITAT TYPES BY PERCENT OCCURRENCE

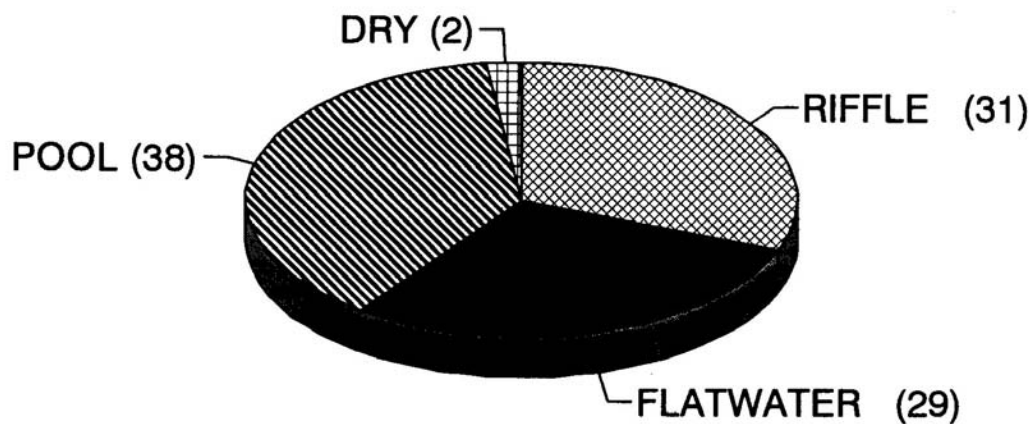

Graph V-1. Comparison of Level II habitat types by percent occurrence.

CALIFORNIA SALMONID STREAM HABITAT RESTORATION MANUAL

Table V-2. Summary of habitat types and measured parameters. Summarizes Level IV physical fish habitat of the stream surveyed. From this data, graphs can be generated to compare habitat types by percent occurrence, total length, percent total length, total volume, etc.

JUGHANDLE CREEK																
Drainage: PACIFIC OCEAN																
Table 2 - SUMMARY OF HABITAT TYPES AND MEASURED PARAMETERS																
Survey Dates: 10/28/96 to 10/30/96																
Confluence Location: QUAD: FORT BRAGG LEGAL DESCRIPTION:																
LATITUDE:39°22'37" LONGITUDE:123°48'55"																
HABITAT	UNITS	HABITAT	HABITAT	MEAN	TOTAL	TOTAL	MEAN	MEAN	MAXIMUM	MEAN	TOTAL	MEAN	TOTAL	MEAN	MEAN	MEAN
UNITS	FULLY	TYPE	OCCURRENCE	LENGTH	LENGTH	LENGTH	WIDTH	DEPTH	DEPTH	AREA	AREA	VOLUME	VOLUME	RESIDUAL	SHELTER	CANOPY
#	MEASURED		%	ft.	ft.	%	ft.	ft.	ft.	sq.ft.	sq.ft.	cu.ft.	cu.ft.	POOL	VOL	RATING
														EST.	EST.	%
100	11	LGR	30	18	1828	21	5	0.2	0.7	93	9270	21	2149	0	6	99
1	1	HGR	0	8	8	0	8	0.1	0.3	45	45	5	5	0	10	100
2	1	CAS	1	32	64	1	10	0.5	1.1	420	840	210	420	0	70	92
41	6	RUN	12	21	860	10	7	0.4	0.9	179	7357	60	2462	0	12	97
56	4	SRN	17	53	2959	34	6	0.4	0.7	158	8828	61	3440	0	63	99
3	1	TRP	1	57	170	2	6	1.0	2.6	366	1098	366	1098	183	10	100
84	12	MCP	25	23	1915	22	8	0.8	2.7	162	13645	141	11858	113	40	98
4	2	LSL	1	20	81	1	10	1.1	2.3	212	848	224	898	171	38	100
5	2	LSR	2	21	105	1	7	1.0	2.1	136	680	173	866	157	40	100
2	1	LSBk	1	26	51	1	8	0.7	1.9	224	448	157	314	134	5	100
23	3	PLP	7	14	331	4	6	0.8	2.3	91	2101	76	1746	63	35	98
6	2	BPL	2	18	108	1	8	0.7	1.9	184	1104	143	859	102	48	98
5	0	DRY	2	15	74	1	0	0.0	0.0	0	0	0	0	0	0	0
1	0	CUL	0	38	38	0	0	0.0	0.0	0	0	0	0	0	0	0
TOTAL	TOTAL				LENGTH					AREA	TOTAL VOL.					
UNITS	UNITS				(ft.)					(sq.ft)	(cu.ft)					
333	46				8592					46264	26114					

JUGHANDLE CREEK

HABITAT TYPES BY PERCENT TOTAL LENGTH

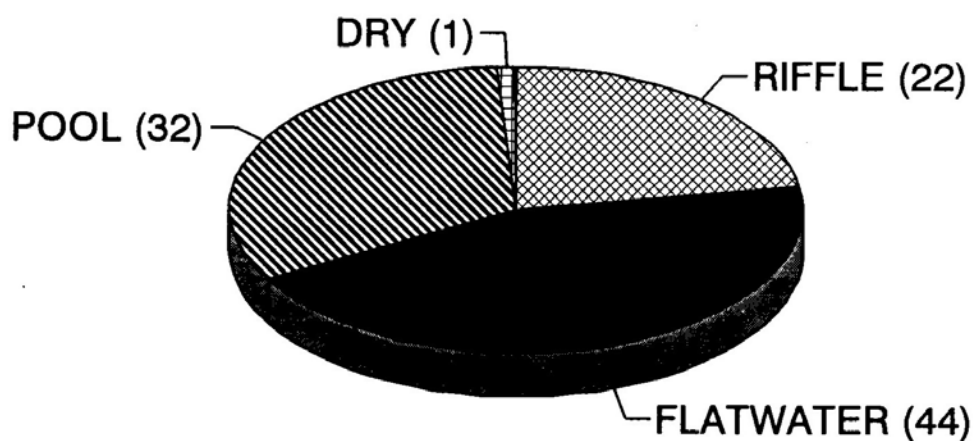

Graph V-2. Comparison of Level IV habitat types by percent occurrence.

CALIFORNIA SALMONID STREAM HABITAT RESTORATION MANUAL

Table V-3. Summary of pool types. Summarizes Level III pool habitat types.

JUGHANDLE CREEK

Drainage: PACIFIC OCEAN

Table 3 - SUMMARY OF POOL TYPES

Survey Dates: 10/28/96 to 10/30/96

Confluence Location: QUAD: FORT BRAGG LEGAL DESCRIPTION:

LATITUDE:39°22'37" LONGITUDE:123°48'55"

HABITAT UNITS	UNITS FULLY MEASURED	HABITAT TYPE	HABITAT PERCENT OCCURRENCE	MEAN LENGTH (ft.)	TOTAL LENGTH (ft.)	PERCENT TOTAL LENGTH	MEAN WIDTH (ft.)	MEAN DEPTH (ft.)	MEAN AREA (sq.ft.)	TOTAL AREA EST. (sq.ft.)	MEAN VOLUME (cu.ft.)	TOTAL VOLUME EST. (cu.ft.)	MEAN RESIDUAL POOL VOL. (cu.ft.)	MEAN SHELTER RATING
87	13	MAIN	69	24	2085	76	7.8	0.9	178	15495	158	13786	118	37
34	8	SCOUR	27	17	568	21	7.5	0.9	149	5075	147	5014	122	33
6	2	BACKWATER	5	18	108	4	8.0	0.7	184	1104	143	859	102	48
TOTAL UNITS	TOTAL UNITS				TOTAL LENGTH (ft.)				TOTAL AREA (sq.ft.)			TOTAL VOL. (cu.ft.)		
127	23				2761				21673			19660		

JUGHANDLE CREEK HABITAT TYPES BY PERCENT OCCURRENCE

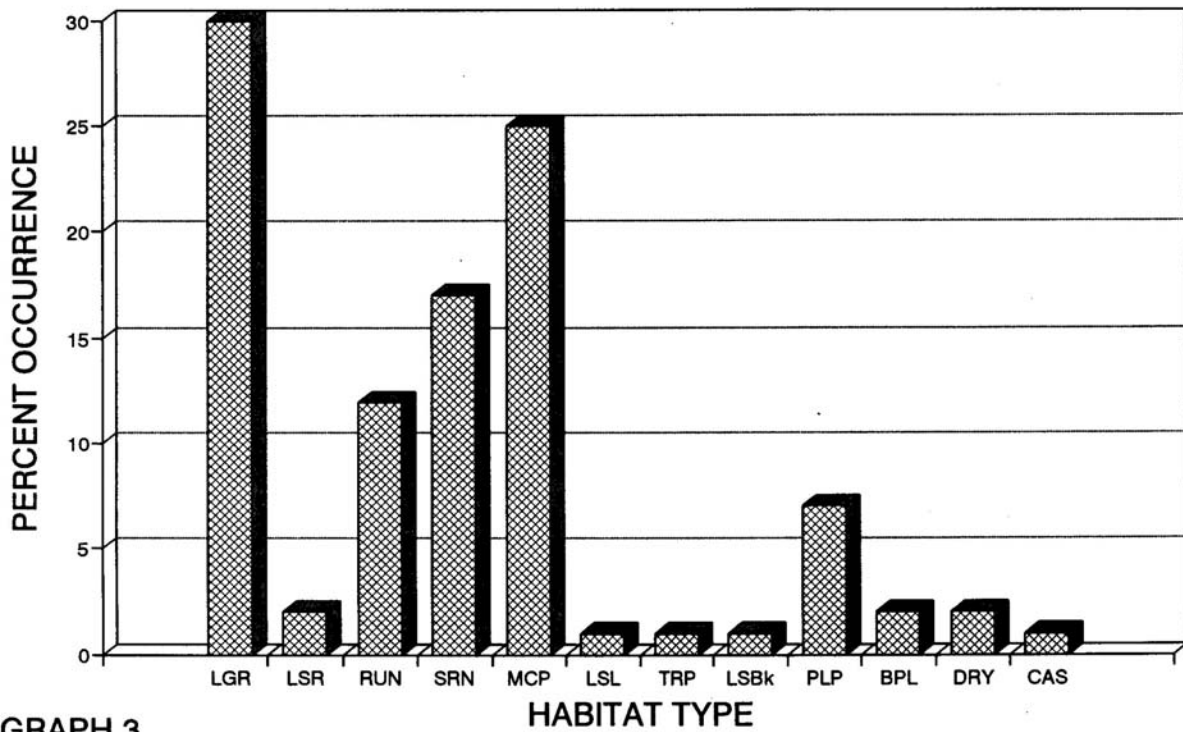

GRAPH 3

Graph V-3. Comparison of Level III pool habitat types by percent occurrence.

CALIFORNIA SALMONID STREAM HABITAT RESTORATION MANUAL

Table V-4. Summary of maximum pool depths by pool habitat types. Summarizes Level IV pool depths by habitat type.

UNITS MEASURED		HABITAT TYPE	HABITAT PERCENT OCCURRENCE	<1 FOOT MAXIMUM DEPTH	<1 FOOT PERCENT OCCURRENCE	1-<2 FT. MAXIMUM DEPTH	1-<2 FOOT PERCENT OCCURRENCE	2-<3 FT. MAXIMUM DEPTH	2-<3 FOOT PERCENT OCCURRENCE	3-<4 FT. MAXIMUM DEPTH	3-<4 FOOT PERCENT OCCURRENCE	>=4 FEET MAXIMUM DEPTH	>=4 FEET PERCENT OCCURRENCE
3		TRP	2	0	0	1	33	2	67	0	0	0	0
84		MCP	66	4	5	61	73	16	19	3	4	0	0
4		LSL	3	0	0	2	50	2	50	0	0	0	0
5		LSR	4	3	60	1	20	1	20	0	0	0	0
2		LSBk	2	0	0	2	100	0	0	0	0	0	0
23		PLP	18	0	0	14	61	8	35	0	0	1	4
6		BPL	5	0	0	5	83	1	17	0	0	0	0

TOTAL

UNITS

127

JUGHANDLE CREEK

Drainage: PACIFIC OCEAN

Table 4 - SUMMARY OF MAXIMUM POOL DEPTHS BY POOL HABITAT TYPES

Survey Dates: 10/28/96 to 10/30/96

Confluence Location: QUAD: FORT BRAGG LEGAL DESCRIPTION:

LATITUDE:39°22'37" LONGITUDE:123°48'55"

JUGHANDLE CREEK

PERCENT EMBEDDEDNESS

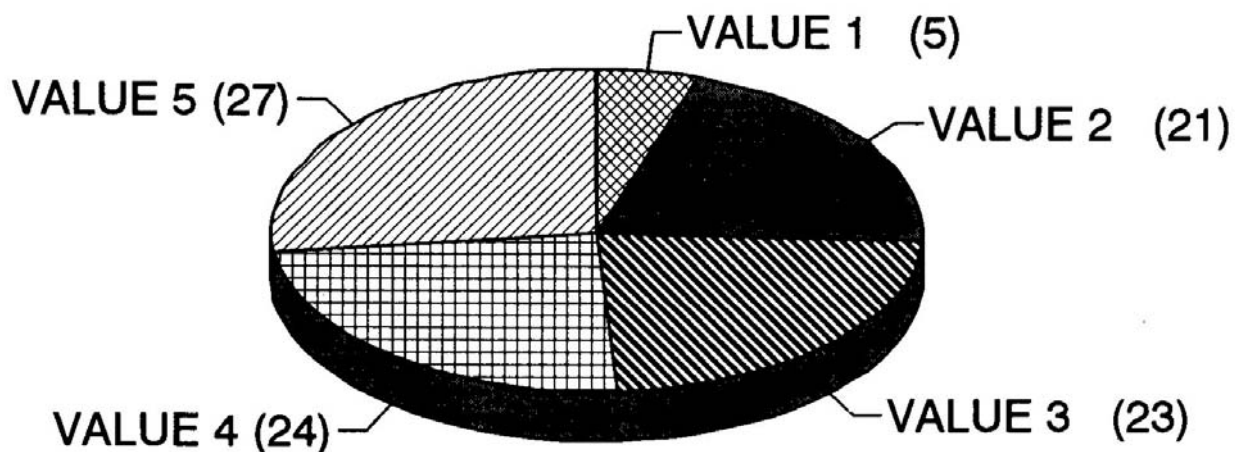

Graph V-4. Summary of mean percent embeddedness of substrate in pool trail.

CALIFORNIA SALMONID STREAM HABITAT RESTORATION MANUAL

Table V-5. Summary of mean percent cover by habitat type. In this example the majority of the cover consists of small and large woody debris.

JUGHANDLE CREEK			Drainage: PACIFIC OCEAN								
Table 5 - SUMMARY OF MEAN PERCENT COVER BY HABITAT TYPE			Survey Dates: 10/28/96 to 10/30/96								
Confluence Location: QUAD: FORT BRAGG LEGAL DESCRIPTION:			LATITUDE:39°22'37" LONGITUDE:123°48'55"								
UNITS MEASURED	UNITS FULLY MEASURED	HABITAT TYPE	MEAN % UNDERCUT BANKS	MEAN % SWD	MEAN % LWD	MEAN % ROOT MASS VEGETATION	MEAN % TERR. VEGETATION	MEAN % AQUATIC VEGETATION	MEAN % WHITE WATER	MEAN % BOULDERS	MEAN % BEDROCK LEDGES
100	8	LGR	0	69	0	0	9	0	0	23	0
1	1	HGR	0	0	0	0	0	0	0	100	0
2	1	CAS	0	0	10	0	0	0	0	90	0
41	4	RUN	15	25	30	0	13	0	0	18	0
56	4	SRN	25	13	38	0	0	0	0	25	0
3	1	TRP	30	70	0	0	0	0	0	0	0
84	12	MCP	3	28	54	3	0	0	1	11	0
4	2	LSL	0	15	85	0	0	0	0	0	0
5	2	LSR	30	25	45	0	0	0	0	0	0
2	1	LSBk	0	100	0	0	0	0	0	0	0
23	3	PLP	13	0	23	17	0	0	3	43	0
6	2	BPL	25	40	35	0	0	0	0	0	0
5	0	DRY	0	0	0	0	0	0	0	0	0
1	0	CUL	0	0	0	0	0	0	0	0	0

CALIFORNIA SALMONID STREAM HABITAT RESTORATION MANUAL

Table V-6. Summary of dominant substrate by habitat type. Summarizes dominant substrate of Level IV habitat types. In this example the majority of substrates consist of sand and gravel.

JUGHANDLE CREEK

Drainage: PACIFIC OCEAN

Table 6 - SUMMARY OF DOMINANT SUBSTRATES BY HABITAT TYPE

Survey Dates: 10/28/96 to 10/30/96

Confluence Location: QUAD: FORT BRAGG LEGAL DESCRIPTION:

LATITUDE:39°22'37" LONGITUDE:123°48'55"

TOTAL HABITAT UNITS	UNITS FULLY MEASURED	HABITAT TYPE	% TOTAL SILT/CLAY DOMINANT	% TOTAL SAND DOMINANT	% TOTAL GRAVEL DOMINANT	% TOTAL SM COBBLE DOMINANT	% TOTAL LG COBBLE DOMINANT	% TOTAL BOULDER DOMINANT	% TOTAL BEDROCK DOMINANT
100	11	LGR	0	0	82	18	0	0	0
1	1	HGR	0	0	0	100	0	0	0
2	1	CAS	0	0	0	0	0	100	0
41	5	RUN	0	20	80	0	0	0	0
56	4	SRN	0	25	75	0	0	0	0
3	1	TRP	0	0	100	0	0	0	0
84	12	MCP	25	33	42	0	0	0	0
4	2	LSL	0	50	50	0	0	0	0
5	2	LSR	0	50	50	0	0	0	0
2	1	LSBk	0	0	100	0	0	0	0
23	3	PLP	33	67	0	0	0	0	0
6	2	BPL	0	0	100	0	0	0	0
5	0	DRY	0	0	0	0	0	0	0
1	0	CUL	0	0	0	0	0	0	0

**CALIFORNIA SALMONID STREAM
HABITAT RESTORATION MANUAL**

Table V-7. Summary of Mean Percent Vegetative Cover for Entire Stream

Mean Percent Canopy	Mean Percent Conifer	Mean Percent Deciduous	Mean Percent Open units	Mean Right Bank % Cover	Mean Left Bank % Cover
98	36	64	0	93.8	93.2

Note: Mean percent conifer and deciduous for the entire reach are means of canopy components from units with canopy values greater than zero.

Open units represent habitat units with zero canopy cover.

Table V-8. Fish Habitat Inventory Data Summary

STREAM NAME:	JUGHANDLE CREEK	
SAMPLE DATES:	10/28/96 to 10/30/96	
STREAM LENGTH:	8327 ft.	
LOCATION OF STREAM MOUTH:		
USGS Quad Map:	FORT BRAGG	Latitude: 39E 22'37"
Legal Description:		Longitude: 123E 48'55"

SUMMARY OF FISH HABITAT ELEMENTS BY STREAM REACH

STREAM REACH 1

Channel Type: F4	Canopy Density: 98%
Channel Length: 8028 ft.	Coniferous Component: 38%
Riffle/flatwater Mean Width: 6ft.	Deciduous Component: 62%
Total Pool Mean Depth: 0.8 ft.	Pools by Stream Length: 33%
Base Flow: 0.4 cfs	Pools >=3 ft. Deep: 3%
Water: 048- 050EF air: 042-056EF	Mean Pool Shelter Rtn: 38
Dom. Bank Veg.: Brush	Dom. Shelter: Large Woody Debris
Vegetative Cover: 96%	Occurrence of LOD: 36%
Dom. Bank Substrate: Cobble/Gravel	Dry Channel: 26 ft.

Embeddedness Value 1. 5% 2. 20% 3. 23% 4. 25% 5. 27%

STREAM REACH 2

Channel Type: A4	Canopy Density: 98%
Channel Length: 299 ft.	Coniferous Component: 10%
Riffle/flatwater Mean /Width: 9 ft.	Deciduous Component: 90%
Total Pool Mean Depth: 1.0 ft.	Pools by Stream Length: 24%
Base Flow: 0.4 cfs	Pools >=3 ft. Deep: 0%
Water: 049- 049EF Air: 049-049EF	Mean Pool Shelter Rtn: 27
Dom. Bank Veg.: Brush	Dom. Shelter: Boulders
Vegetative Cover: 94%	Occurrence of LOD: 8%

**CALIFORNIA SALMONID STREAM
HABITAT RESTORATION MANUAL**

Dom. Bank Substrate: Cobble/Gravel

Dry Channel: 48 ft.

Embeddedness Value: 1. 0% 2. 50% 3. 17% 4. 9% 5. 33%

Table V-9. Mean Percentage of Dominant Substrate

Dominant Class of Substrate	Number Units Right Bank	Number Units Left Bank	Total Mean Percent
Bedrock	1	2	3.33
Boulder	0	3	3.33
Cobble/Gravel	24	18	46.67
Silt/clay	20	22	46.67

Mean Percentage of Dominant Vegetation

Dominant Class of Vegetation	Number Units Right Bank	Number Units Left Bank	Total Mean Percent
Grass	11	12	25.56
Brush	25	24	54.44
Decid. Trees	2	4	6.67
Conif. Trees	7	5	13.33
No Vegetation	0	0	0

Total stream embeddedness value for pool 3.39

Table V-10. Mean Percent of Shelter Cover Types for Entire Stream

Stream:	JUGHANDLE CREEK	Drainage	PACIFIC OCEAN
Survey Date:	10/28/96 to 10/30/96		
	RIFFLES	FLATWATER	POOLS
UNDERCUT BANKS	8.41	17.78	9.13
SMALL WOODY DEBRIS	31.14	16.67	29.13
LARGE WOODY DEBRIS	30.23	30	45.65
ROOTS	2.05	0	3.91
TERRESTRIAL VEG	2.73	5.56	0
AQUATIC VEG	0	0	0
WHITEWATER	0.45	0	0.87
BOULDERS	18.18	18.89	11.30
BEDROCK LEDGERS	0	0	0

CALIFORNIA SALMONID STREAM HABITAT RESTORATION MANUAL

Data Analysis

Table V-1 shows a basic Level II look at the stream in terms of riffles, pools and flatwater. This view emphasizes the percent occurrence and percent total length of major habitat types and how they relate in terms of water area, depth and volume. Table V-1 also shows total percent pool habitat units to percent riffle and flatwater habitat units, but shows little about critical habitats.

Table V-2 provides a more detailed Level IV summary of the habitats in the surveyed stream. This table shows details such as predominant habitat types, the existence of special habitat types, critical habitats shelter ratings, and the amount of vegetation on the stream bank.

Table V-3 provides a Level III summary of pool habitats. This table displays useful information about the back water and scour pool percent occurrence, volume and shelter. These pool types can provide habitats especially important to salmonids, particularly coho during certain life stages. Refer to Table V-2 for more detailed Level IV information on special pool types which may have specific fish species importance.

Table V-4 provides a detailed look at pool habitats in terms of depth. Primary pools provide critical summer habitat for steelhead and coho under low flow conditions. DFG habitat typing data indicate the better coastal coho streams may have as much as 40 percent of their total habitat length in primary pools. In first and second order streams a primary pool is defined to have a maximum depth of at least two feet, occupy at least half the width of the low-flow channel, and be as long as the low-flow channel width. In third and fourth order streams the criteria is the same, except maximum depth must be at least three feet. Looking at existing primary pool habitat types provides design information for creating additional primary pools.

Table V-5 emphasizes the amount and type of cover found in all the Level IV habitat types. These data describe the stream and are useful for comparison with other streams. These data also display information about the number of habitat units that provide escape cover with large woody debris (LWD). Shelter values of 80 or higher are desirable.

Table V-6 presents stream substrate detail. This information is useful in determining the suitability of the stream's substrate for spawning salmonids. The spawning habitat types for individual species are presented later in Part V.

Table V-8 displays a summary of 19 measurements for each stream reach surveyed. Stream reaches, determined by their unique stream channel types, are a useful way of analyzing the possibilities for stream habitat improvements.

GIS FORMAT

The development of GIS technology has ushered in a whole new era of spatially assisted data analysis. GIS can graphically present the location and frequency of particular critical habitat types, fish species distribution and use, identified problem and project sites, and other important watershed features. This information is useful in the planning, evaluation, and monitoring process associated with watershed and stream improvement programs.

CALIFORNIA SALMONID STREAM HABITAT RESTORATION MANUAL

Software

DFG uses Arc/Info and ArcView GIS software. The suite of tools in Arc/Info allows for finer articulation of spatial features and analysis. A GIS specialist uses Arc/Info in preparing the data and interface for the field biologists and end users. ArcView is a desktop software package. DFG uses this software for the simple display and query of the spatial questions field biologists and managers have. For more information, see Appendix I.

Data

DFG uses hydrographic features, like blue line streams, from the USGS Digital Line Graph and the EPA River Reach File as a base upon which to portray collected habitat information. The habitat data is stored in an ArcView format for use by biologists. Data sources like Digital Elevation Models, soil surveys, slope stability indices, property ownership records, and road system maps, among others, are useful for analysis of watershed restoration potential. These types of spatial data can be obtained from a number of local, state and federal entities. Local GIS users groups can provide useful data contacts.

Analytical Tools

DFG has developed an ArcView interface to display stream characteristics based upon the habitat inventory data exported from the HABITAT program. For example, pool distribution, riffle location, riparian vegetation, and bank composition can all be spatially represented. This information can be displayed and printed on a map for management use.

STREAM REPORTS

Each surveyed stream should have a written report. The report should include the information from the watershed overview (Part II), a summary of the habitat inventory (Part III), results of the biological survey (Part IV), and a listing of specific problems discovered during the field survey. The DFG report format is found in Appendix J. These reports are used by fish habitat specialists, biologists, and landowners to plan and analyze habitat improvements.

The information entered on the Watershed Overview Work Sheet serves as the summary report for the watershed assessment. A brief statement about historical stream surveys, sediment sources, and basin hydrology should be included in this report.

The field data collected is most useful when presented in summary tables and graphs. Information on biological observations, significant landmarks and conditions observed during the habitat inventory are included in the report.

CALIFORNIA SALMONID STREAM HABITAT RESTORATION MANUAL

DATA MANAGEMENT

Data Storage

Once data has been collected, analyzed, and reports generated, the original purpose of the data collection effort may have been accomplished. There are, however, benefits from maintaining both the original data and the reports so they are both secure from loss and easily accessible. Traditionally, storage of these data have been in filing cabinets or boxes, which often limit distribution and access. Data are often lost when storage space becomes an issue, and files are discarded. Electronic storage facilitates data security, access, and sharing.

Data Distribution

Distribution of the data and final reports to several locations will insure against loss and will make the information more widely available. Within DFG, all computerized stream habitat inventory information is sent to the GIS specialist at Inland Fisheries Division (IFD) in Sacramento. All previous habitat data collected and their associated reports are stored on a server at IFD. Additional copies of the reports are sent to the appropriate DFG regional offices, and other involved agencies and landowners. Other possible data repositories include colleges, universities, and state agencies with land and water management responsibilities.

RECOMMENDATIONS

Interpreting Physical Habitat and Biological Inventories and Relating this Information to Critical Habitat Needs

Critical habitat needs must be met for a species or community to exist or prosper in a specified environment. A habitat inventory conducted to assess the need for stream channel improvements should provide sufficient detail to enable the investigator to identify these needs. The inventory will identify and quantify the physical habitat available and include fish distribution surveys to record species present. This will provide baseline data to identify unmet critical habitat needs. Based on this information, some predictions can be made regarding potential habitat gains and losses for each species before habitat work is initiated.

Whenever possible, at least two surveys should be done at different times of the year. One survey should be completed during summer low flow to estimate summer rearing habitat, identify which species of salmonids are using this habitat, and their distribution in the stream. A second should be done during the winter to determine winter rearing area, spawning gravel, early rearing habitat, and the salmonid species present.

Factors other than physical habitat may limit production of juvenile salmonids in any given year. Biological factors such as disease, predation, competition, and food availability, or factors such as water quality, weather, or water management practices may account for some of the variation in salmonid production.

CALIFORNIA SALMONID STREAM HABITAT RESTORATION MANUAL

Habitat improvement is typically accomplished for the benefit of a particular species or species group. Therefore, the identified critical habitat needs must be keyed to the target species. Each life stage of the target species during freshwater residency needs to be identified, and the critical habitat needs ascertained. For example, typical life stages for steelhead trout in an inland environment include spawning migration, spawning, year-round rearing and emigration. Once all the critical habitat needs for the target species are identified, they will need to be defined in terms of habitat type prior to initiation of any habitat modification project.

Region 5, USFS, has established a "Fish Habitat Relationships Program." The purpose of this program is to "...research and develop information on fish ecology and to coordinate effective applications of this knowledge in managing and protecting fisheries. By relating life stage requirements of species to physical habitat parameters, we are aiming at our main objective: developing a methodology to manage fisheries through the management of habitat." To develop these fish habitat relationships, physical and biological habitat variables are being considered. These include depth, velocity, substrate, cover, temperature, and food availability in a stream as they relate to fish distribution, abundance, and community structure. An illustration of the seasonal critical habitat needs for steelhead and chinook salmon at various life stages is given in Figure V-1. Research such as the "Fish Habitat Relationships Program" serves as a basis for determining critical habitat needs, and for planning habitat improvement projects.

Habitat inventory coupled with fish distribution surveys provides the basic information to determine the need for habitat restoration or enhancement. The fish habitat relationship models being developed and tested by the USFS should provide a tool to aid in conversion of stream survey results to working restoration plans.

**CALIFORNIA SALMONID STREAM
HABITAT RESTORATION MANUAL**

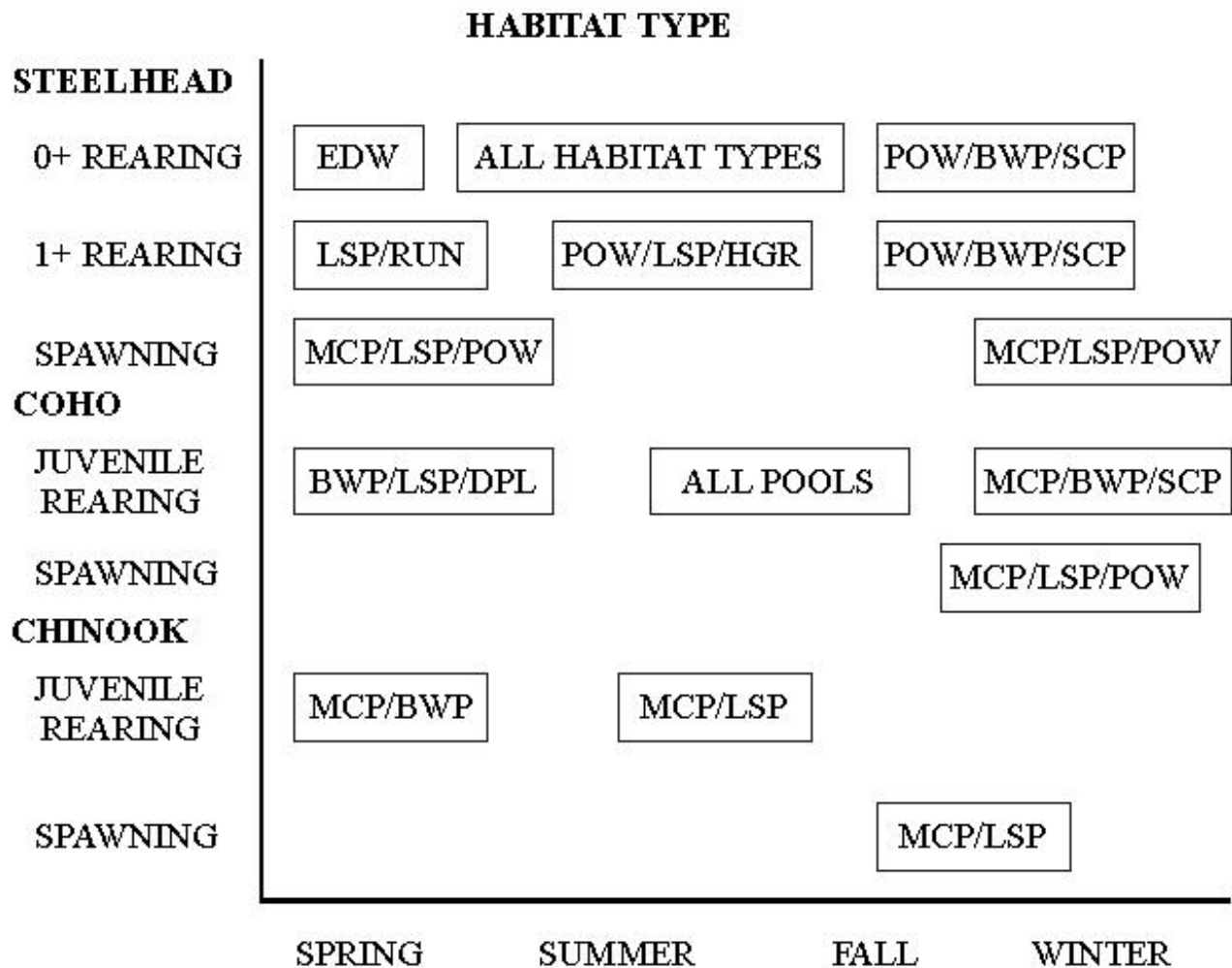

Figure V-1. Critical habitat needs. LSP represents all lateral scour pools. BWP represents all backwater pools. (McCain, Fuller, Decker, and Overton, 1990).

The "Summary of Habitat Types and Measured Parameters", Table V-2 above, compiled from the Jughandle Creek habitat inventory data showed that 22 percent of the total length of the stream was low-gradient riffle, 44 percent was flatwater run and the other 34 percent consisted of various types of pool habitats. Summer electrofishing was conducted and found some 0+ steelhead and a few 1+ and 2+ steelhead as well. Based on fish habitat relationship studies (Figure V-1), the assumption can be made that by converting some flatwater run habitat into mid-channel pools, lateral scour pools, and/or pocket water, spawning and rearing habitat could benefit this species. Further bioinventory should be utilized to detect coho or chinook presence if it should occur.

CALIFORNIA SALMONID STREAM HABITAT RESTORATION MANUAL

Salmonid Habitat Requirements and Suggestions for Instream Structures to Enhance Critical Habitat

Each species of salmonid has a unique life cycle and habitat requirements. Understanding critical habitat needs is essential to developing effective enhancement projects. This section will discuss: 1) general habitat requirements for anadromous fish species; and 2) reliance upon instream structures to meet critical habitat requirements.

Depending on the stream and time of year, more than one species of salmonid may be present. Adding structures to a stream with more than one species may benefit all species to some degree. To mimic natural conditions, a variety of structures can be installed to create a diversity of desirable habitats. Creation of complex depths, velocities, substrate, and cover types at various flow levels will maximize the probability that appropriate niches will be provided for all species. However, some structures will benefit one species more than others.

For example, addition of escape cover structures to long pools typically will benefit juvenile chinook, coho and steelhead. Juvenile salmon and trout tend to utilize the head and tail of a pool, but its center may not be occupied. By anchoring several logs in the pool, it can be divided into essentially two or more pools with increased effective cover.

Project design process provides the transition from assimilation of habitat inventory data to habitat modification projects. The following are brief discussions, by species, of habitat requirements and suggestions for instream structures to enhance critical habitat.

Chinook Salmon

Bays, estuaries, and the lower reaches of mainstem streams are important habitats for chinook salmon. These habitats provide holding areas for adults and rearing areas for juveniles. In many river systems these vital habitats have been reduced by the effects of land use, development, and natural events. Examples include water diversion, diking, tide gating, gravel extraction, and high levels of sediment deposition. These activities usually reduce pool habitat and escape cover, and leave shallow open channels. These problems can restrict adult access to preferred upper basin reaches where spawning success is highest. It is very difficult to improve these large areas with instream treatments. Improved land use practices within the watershed will eventually improve conditions in the lower stream reaches.

Adult holding areas are particularly important to spring chinook who must reside in the stream throughout the summer months. In low water years or during low rainfall periods holding areas may also be especially important for adult fall chinook. Both spring and fall chinook select large, deep pools with complex cover or glides and riffles with sufficient water depth and log and/or boulder cover. Typical ways to enhance holding areas for chinook are by securing logs along pool edges, or submerging logs to increase pool cover. Large boulders or groups of boulders added to pools, glides or riffles can also enhance and/or create chinook holding habitat.

CALIFORNIA SALMONID STREAM HABITAT RESTORATION MANUAL

Chinook salmon generally spawn in water from one to three feet deep. However, spawning can occur in depths from 0.5 to greater than 20 feet deep. Other criteria include water velocities of 1 to 3 feet per second, a gradient of 0.2 to 1.0 percent, and substrate from 0.5 to 10 inches dominated by 1- to 3-inch cobble. Escape cover for spawning adults is also important. The location of spawning will vary from one year to another depending on the timing and amount of fall and winter rains. In drought years, spawning may occur in mainstem rivers, while during years of higher flows, spawning may occur in upper basin tributaries. In mainstem or large tributaries, large boulder, diagonal or downstream "V" weirs can capture and stabilize spawning gravel. Boulder or log cover structures can be installed in conjunction with the weir structures. Boulder clusters, and single and opposing wing-deflectors are also effective in maintaining and stabilizing chinook spawning gravel. In rivers or streams lacking gravel for recruitment, such as those below dams, gravel may need to be added on a regular basis.

Immediately after emergence, the chinook fry are found in quiet water areas, along the stream bank, close to cover such as tree roots or logs. Juvenile chinook move into locations of higher velocity, either along the stream margin or in boulder runs away from the shore. Most chinook smolts migrate to the estuary or ocean in the spring. Some juveniles may remain in large pools with complex cover until they emigrate in the fall. Structures that create quiet water or debris accumulation at the stream margins are beneficial for fry survival following emergence. The enhancement or creation of large, deep pools with abundant cover can increase rearing potential for chinook juveniles.

Coho Salmon

Coho salmon have a more extended freshwater stage in their life history than chinook. Young coho spend their first year of life in the riverine environment prior to migrating to the ocean. Consequently, adequate cover, cool water, and sufficient food to sustain them through their fry and juvenile stages become critical habitat components. Juveniles are normally found in relatively slow current, and prefer water temperatures within the range of 48° to 60° Fahrenheit. In California, coho rearing habitat is generally more limiting than spawning habitat.

The quantity of spawning gravel for coho salmon is generally adequate in most California streams, although quality of the gravel may be a problem in some areas. Structures to develop pools for rearing habitat usually improve spawning reaches by trapping gravel, and creating hydraulic conditions that keep fine sediments in suspension. Instream log and boulder weirs, boulder clusters, log and boulder deflectors in series, or other structures, including the placement of large wood and root wads, will create improved habitat conditions.

Emergent coho fry require shallow, quiet areas, usually associated with backwater pools, and dammed pools, but they are also found in side channels and along the quiet water margins of other types of habitats. In periods of high flows and cold water temperatures, juvenile coho shift to slow, deep pools, beaver ponds, or to side channels and backwater pools off the main stream. Under these conditions, the young fish are torpid and seek cover under rocks, tree roots, logs, debris, and in log jams. Projects should be designed that will create backwater, dammed, and secondary channel pool habitat, and add cover complexity to coho streams lacking these elements.

CALIFORNIA SALMONID STREAM HABITAT RESTORATION MANUAL

During summer, preferred habitats are primary pools or backwater eddies in association with an undercut bank, submerged tree roots, or branches and logs. During summer periods young coho require cool water temperatures. Stream canopy should be approximately 80 percent to maintain suitable water temperatures. Projects should be designed to protect and develop multi-storied near-stream forests to provide shade, woody debris, and organic nutrients to the stream. Boulder-root wad combinations, large wood accumulations, whole trees, boulder clusters, and digger logs provide escape cover and can be used to create primary pools. Tree tops, branches, and other small woody debris provide especially good summer cover for coho.

Steelhead

Adult spring-run steelhead (sometimes referred to as summer steelhead), like spring-run chinook, require cool, deep pools for holding through the summer, prior to spawning in the winter. These races of fish are not abundant, and are found primarily in parts of the Klamath and Eel systems. Although water quality and holding cover are crucial, poaching may be the most serious threat to their survival. The more abundant fall and winter races of steelhead share habitats common to coho and chinook salmon. Steelhead have more variable life histories than salmon. Although they generally remain in fresh water for two years prior to entering the ocean, some steelhead enter the ocean after one year in fresh water, some after three or more years, and some never leave fresh water. Those that stay longer in fresh water, thus entering the ocean at a larger size, are more likely to return as fully mature spawners.

Steelhead spawning habitat requirements are similar to those for coho salmon. The gravel size preferred by steelhead is generally 0.5 to 6 inches dominated by 2- to 3-inch gravel. Unlike salmon, steelhead will spawn in relatively small pockets of gravel. Generally, spawning habitat is not thought to limit steelhead production. Instream structures, such as log and boulder weirs, deflectors, and clusters, installed to enhance steelhead rearing often also improve spawning habitat.

During their first summer, steelhead are generally found in relatively shallow areas, with cobble or boulder bottoms at pool tailouts, or in riffles less than 24 inches deep. In winter, they are found under large boulders in shallow riffles and quiet backwater areas. Preferred summer habitat of young-of-year (YOY) juveniles include log debris accumulations, heads of pools, runs, and riffles. Large boulder substrate is important in runs and riffles. Surface turbulence or white water is also an important overhead cover feature in these areas. During winter, YOY steelhead are found in pools, or along stream margins containing debris, logs or boulders. Most cover structures, such as boulder clusters and root wads, provide both summer and winter rearing. In very cold areas, adequate and stable interstitial habitat and low velocities are needed for lethargic YOY steelhead, since they tend to enter the substrate when temperatures reach approximately 40° Fahrenheit.

Summer rearing habitat that provides cool water pools with extensive cover for 1+ and older steelhead is typically a factor limiting steelhead production in California streams. Sometimes, turbulence and depth alone may be adequate sources of cover. In large streams, 1+ fish also rear in glides and riffles with wood or boulder cover or in pocket water around boulders. Narrowing and deepening the channel, and providing adequate shade can reduce summertime stress on steelhead by keeping maximum temperatures below 65E Fahrenheit. Branches from hardwood trees can be cabled in pools to provide cover. Boulder clusters added to riffles create

CALIFORNIA SALMONID STREAM HABITAT RESTORATION MANUAL

good summer rearing habitat for 1+ fish. Boulder weirs provide turbulence and edge cover, creating desirable rearing habitat. On bedrock streams, pools may be created with weirs or by blasting. After blasting a pool in bedrock, addition of a weir or channel constriction is often necessary to keep the pool from filling in with silt or gravel.

Backwater pools, secondary channel pools, and pocket water are winter habitat types that provide refuge during periods of high water. These habitats may be limited in California and can be difficult to create. Boulder clusters added to riffles, log and root wad cover added to lateral scour pools and quiet water areas, and undercuts associated with weirs can provide these critical habitats.

Coast Cutthroat Trout

Coast cutthroat trout prefer low-gradient streams with log debris accumulations, and extensive shade canopy. Cutthroat trout may reside in fresh water for several years prior to emigration, or they may reproduce having never made an ocean journey. Stream improvement efforts should focus on creating optimum year-round stream habitats similar to those required for coho and steelhead.

Resident Trout

Resident trout encounter many of the same problems, and benefit from many of the same types of projects designed for salmon and steelhead. Determination of critical habitat needs should be made with a thorough understanding of the species in question. It is always necessary to know the management strategy for the stream before planning projects and to obtain specific information about local conditions and species life history.

Lack of instream cover and overhead canopy, plus stream aggradation caused by extensive ground disturbance from land management activities, are common problems in resident trout streams. These conditions can lead to increased water temperatures, loss of pools, and reduced habitat diversity. Long-term solutions to these problems can only be achieved with adoption of better land use practices. Stream habitat restoration activities can help increase fish production and meet critical habitat needs.

Trout habitat in streams flowing through meadow areas are commonly degraded by livestock grazing. Fencing, or other means of preventing livestock access to the riparian vegetation adjacent to the stream, is often all that is necessary to allow the natural recovery process to begin. Recovery may be hastened by intensive restoration efforts such as riparian plantings, log cribbing to reestablish undercut banks, or stream elevation control structures to stop down-cutting and raise the water table. Restoration plans for meadow areas must include long-term agreements for control of access to the riparian corridor. Without an adequate grazing management plan or an agreement to maintain fencing, money and effort spent on restoration will be wasted.

CALIFORNIA SALMONID STREAM HABITAT RESTORATION MANUAL

PART VI

PROJECT PLANNING AND ORGANIZATION

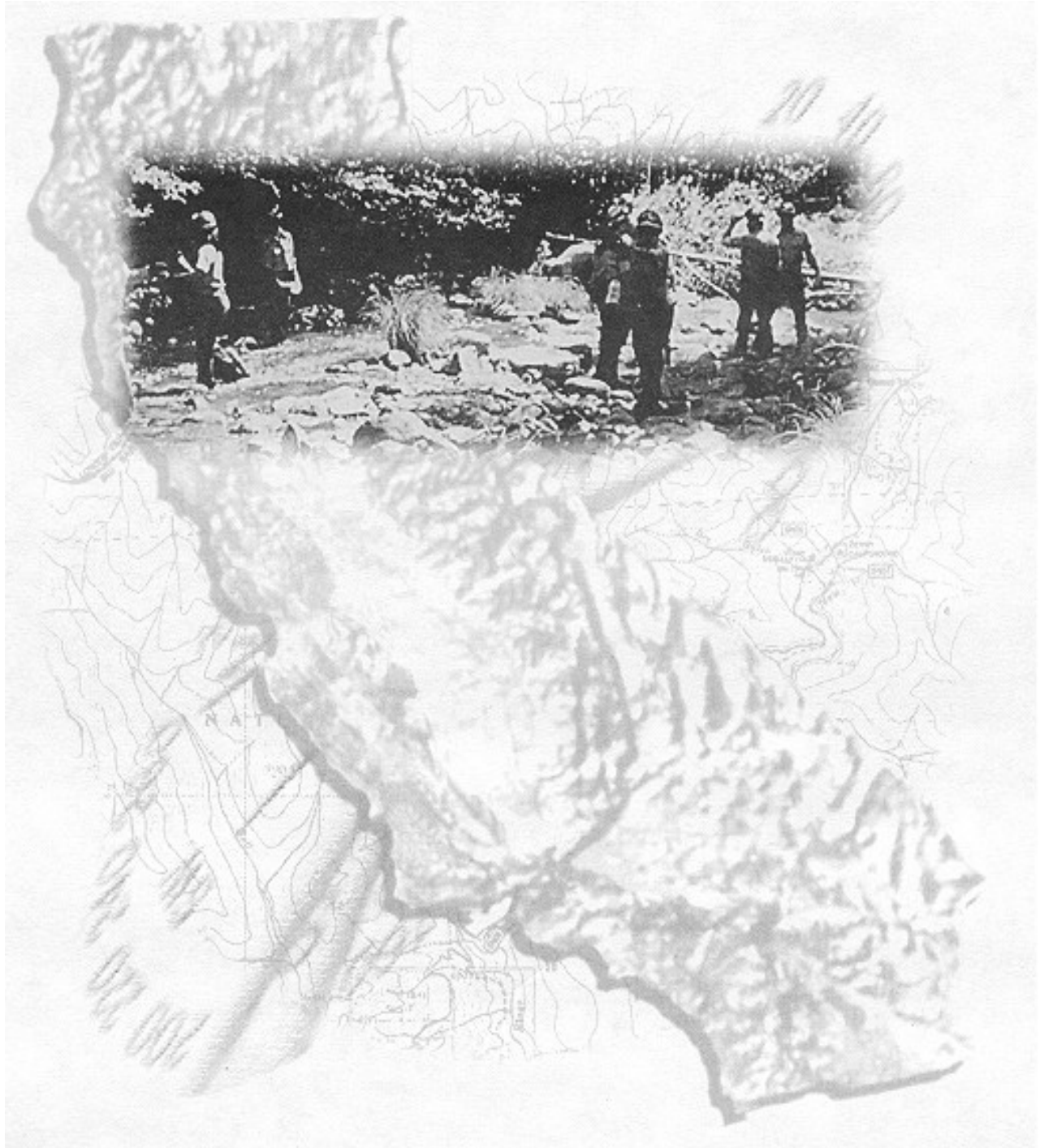

CALIFORNIA SALMONID STREAM HABITAT RESTORATION MANUAL

PART VI PROJECT PLANNING AND ORGANIZATION

The information and methodologies in this manual are intended to guide instream habitat improvement efforts to effect an increase in salmonid population numbers. However, there are factors that can occur in other phases of a targeted species life history that must be considered before initiating habitat improvement projects. Some of these include adverse oceanographic conditions, disrupted watershed and stream-side conditions, water diversions, migration barriers, excessive harvest, introduced predators, or the presence of toxic substances causing the loss of suitable water quality. Proponents should consult with local residents, as well as resource professionals like DFG basin planners and biologists on these and other issues before proceeding with instream habitat project and layout.

When extraneous factors are found to be suppressing the population of a species, consideration must be given to addressing those factors prior to further consideration of stream habitat modification. For example, if legal harvest of the target species is identified as a primary limiting factor, it should be addressed through the regulatory process; however, it is possible that this process could occur concurrently with stream habitat improvement efforts. Usually, a multi-faceted restoration prescription that includes watershed, riparian, instream, artificial propagation, conservation education, and regulation treatments is the best approach to take.

Final selection of project options will frequently be dictated by availability of funds, access, ownership, materials, capability of construction crews, and environmental protection considerations. In any case, other valuable fish and wildlife habitats should not be sacrificed for the benefit of a project unless there is clearly a net beneficial result to the environment as a whole and all losses are fully offset. There are many reasons why stream habitat modification may or may not be appropriate, but lack of assessment, analysis, imagination, inventiveness, or commitment by the planner or habitat specialist should not be among them. If, after thorough analysis, no reasonable habitat improvement project can be identified on a particular stream, none should be further promoted at the time. DFG Basin Planning efforts can help provide guidance to streams with suitable project reaches and sites, and recommend appropriate habitat improvement activities.

After historic and current watershed conditions, fish habitat, and fish populations have been inventoried and analyzed and a decision has been made to develop a restoration prescription, specific restoration treatments can be designed. Landowners and involved agencies must be consulted to ensure their interest and cooperation. Next, a written work plan must be developed for the overall project and its individual work sites. The work plan must identify present conditions, project objectives, expected results, and estimated labor, materials, tools, and equipment necessary to complete the project. The work plan must identify any necessary permits, and all permits must be in possession before any on-site work can begin. Regardless of permits, no work can be performed instream as long as there is a possibility that live salmonid eggs or fry are present. The plan should also include project evaluation and monitoring strategies.

CALIFORNIA SALMONID STREAM HABITAT RESTORATION MANUAL

Permits That May Be Required

- **Access Agreement.** This agreement is necessary to not only do the development work, but to enter onto property other than your own to do preliminary survey work. This agreement must be reached between the project sponsor and the landowner or manager.
- **Streambed Alteration Agreement.** This agreement, issued by the Department of Fish and Game, is necessary to perform any physical manipulation of the stream, including vegetation, within the high water mark (Fish and Game Code, Sections 1601/1603).
- **U.S. Army Corps of Engineers 404 Permit.** This permit, required pursuant to the Clean Water Act, may or may not be needed, but if the project proposes removal or placement of any materials in the stream area, or if the project area is a wetland, then the project proponent must apply to the Corps of Engineers to determine if a permit is necessary.
- **U.S. Army Corps of Engineers Section 10 Permit.** This permit, required pursuant to the Harbors and Rivers Act, is to be obtained for any construction between high water marks of navigable rivers.
- **Section 401 of the Clean Water Act.** Section 401 of the Clean Water Act requires that the California Regional Water Quality Control Board determine consistency between proposed projects, California water quality laws, and certain sections of the Clean Water Act. The California Regional Water Quality Control Board has established specific procedures for implementing this section. The project proponent may be required to submit a "Request for Certification" form to the California Regional Water Quality Control Board.
- **Department of Fish and Game Trapping and Rearing Permit.** If the restoration project proposes to trap and rear fish, a trapping and rearing permit must be obtained from the Department before any fish may be handled. This permit process requires the applicant to have an approved five-year management plan before the permit will be issued (Appendix B). Contact the local DFG district fishery biologist.
- **County and State Right-of-Way permits.** If the proposed project is near any public roads it could require agreements or permits with county and state public works departments. In addition, many counties have ordinances against working within a riparian corridor along a stream area. This usually falls under the county planning department.
- **State Lands Commission.** State Lands Commission is a permitting agency responsible for riverbed lands owned in fee by the State as sovereign lands, subject to the public trust for water-related commerce, navigation, fisheries, recreation, open space, and habitat. Project proponents should contact the State Lands Commission to determine if the project falls under Commission jurisdiction.
- **California Environmental Quality Act (CEQA).** Anytime an individual or a group (including public agencies), contracts with the Department of Fish and Game for fish habitat restoration projects, an environmental review is necessary. Individuals or groups

CALIFORNIA SALMONID STREAM HABITAT RESTORATION MANUAL

conducting habitat restoration projects in a volunteer capacity may also need to have an environmental review of proposed projects, and should discuss proposed projects with the DFG district fishery biologist during the planning stages.

- **National Environmental Policy Act (NEPA).** This applies to projects which are carried out, financed, or approved in whole or part by federal agencies.
- **National Marine Fisheries Service (NMFS).** Written authorization must be obtained for any activities that may impact a federally listed species.

FISH HABITAT RESTORATION CATEGORIES

Fish habitat restoration can be divided into five general categories: 1) upslope watershed improvements; 2) riparian and stream bank stability treatments; 3) instream habitat improvements; 4) artificial propagation; 5) watershed stewardship training.

Upslope Watershed Treatments

Watershed features determine the general condition of streams. In some cases, watershed conditions may preclude successful artificial propagation, instream treatment, or riparian restoration activity for fish. An extremely deteriorated watershed might exhibit poor water quality and result in extirpation of its fish populations. Fine sediments filling pools and sealing gravel, high water temperatures, high pH from mine drainage, or lack of flow during critical times of the year are examples of fish habitat problems that could be attributed to watershed conditions.

A basic inventory of past, current, and planned land and water uses in the watershed is a necessary step prior to restoration project activity. Usually a discussion with the landowner(s) and/or agencies like EPA, NRCS, CDF, or DFG, will provide a general understanding of the watershed. If warranted, sediment sources such as road systems and landslides, or waste water discharge points might need to be investigated further. Watershed inventory methodologies are available, but are beyond the scope of this manual. Watershed treatment techniques are often included in watershed restoration references, and improvement treatments include such varied activities as improved road drainage, road or trail obliteration, reforestation, or changes in land management priorities.

Riparian Zone Treatments

Watersheds and streams are dynamic; therefore, erosion and sediment transport are natural phenomena which can improve as well as degrade fish habitat. Bank failures and landslides can be the major source of large woody debris and boulder recruitment to the stream. Eroding gravel banks are a continuing source of gravel for the stream. High flows may shift gravel bars, cleanse spawning beds, and scour or deepen pools, all to the benefit of spawning and rearing salmonids. Erosion of fine-textured soils such as clays, silts, and fine sands, however, can reduce the quality of fish habitat. In streams or reaches flowing through these soil types, effects of stream enhancement work may be negated if erosion is not reduced or controlled. Part VII discusses various techniques for controlling erosion detrimental to fish production.

CALIFORNIA SALMONID STREAM HABITAT RESTORATION MANUAL

Near-stream and riparian zones supply the stream with large woody debris (LWD) that form the roughness elements the stream needs to provide diverse fish habitats. DFG has developed a survey methodology for assessing LWD in the stream channel, as well as live, dead, and downed trees in the near-stream vegetation zone. This survey can provide the information needed to better manage land use activity in these areas. The survey identifies revegetation project sites if needed; Part III contains this methodology.

Instream Habitat Improvements

Physical conditions within stream channels can be modified to improve or increase particular habitats and the overall mix of habitat types for salmonids. However, if such modifications are to have any degree of permanence and success, they must take into account the principles of stream hydraulics. The value of modifications depends on correct identification of critical stream habitat needs affecting the species in question. Part VII includes guidelines for location and design of instream structures for rearing and spawning habitat. Part III contains information on structure suitability by stream type.

Barriers to fish migration dramatically constrain fish populations. Impassible natural barriers define the limit of anadromous salmonid migration. Other temporary obstructions, such as log jams, landslides, beaver dams, and some plunges, occur and may impede fish passage into historically used reaches. Other structures such as dams and improperly installed road culverts also impede fish passage. Before a barrier modification project is undertaken, fish populations and habitats below and above the obstruction should be assessed. A review of historical information and a visual inspection or other sampling procedures should be conducted to identify fish populations and habitat potential. If the barrier is a natural geological feature, such as a waterfall, then special consideration should be given to the possibility that any fish found above the barrier may be part of an isolated population, that could be harmed by competition from downstream populations. Part VII, "Fish Passage," describes various approaches to overcoming both natural and human-induced obstructions.

In instream habitat improvement projects, including barrier modification, the potential short-term benefit for fish can be high. Nevertheless, the costs can still outweigh the benefits to be gained. Plans and wishes of involved landowners must be considered during any decision making process. Each situation must be individually evaluated.

Artificial Propagation

Artificial propagation is sometimes desirable to accelerate utilization of expanded or improved habitat conditions by a target species. This activity is intended to be short term and closely coordinated with other elements in the fishery restoration program. The DFG District Biologist must be closely consulted concerning the appropriateness of this activity. Timing, duration, location, availability of genetically suitable brood stock, and stock transfer are some of the elements that must be considered. Appendix B, "Cooperative Fish Production in California," provides guidelines to be followed when artificial fish production is considered.

CALIFORNIA SALMONID STREAM HABITAT RESTORATION MANUAL

Watershed Stewardship Training

If restoration activities being considered are to have a lasting and meaningful effect on the watershed and its drainage system, a public buy-in or education program in watershed stewardship is necessary. Public involvement should include landowners and managers, all sectors of the local community, and the area's public schools.

There is an active and widespread program using aquaria in school classrooms to teach appreciation of the aquatic environment. These projects, which are supported by DFG and various organizations, allow students to hatch salmonids, rear to fry, and release them to suitable streams. During this activity a coordinated watershed and stream environment curriculum is taught.

Practical watershed restoration advice for landowners, as provided by university extension advisors, NRCS, or watershed groups, can be an effective means of promoting fishery restoration. Rural watershed landowners and managers are usually receptive to suggestions to improve their road systems, especially if it can be demonstrated that they can save time and money in the process. Generally, landowners want their roads in useable condition, and they also want to retain the topsoil and productivity of their lands. Therefore, most landowners welcome constructive alternatives to conditions that are contributing to loss of desirable fish habitat.

INSTREAM STRUCTURE SUITABILITY BY STREAM TYPE

Any instream structure must be hydrologically, structurally, and biologically suitable for the specific physical conditions of the site. Adverse consequences of unsuitable structures can include accelerated erosion or deposition, physical structure failure, and displacement or replacement of a beneficial species. Stream channels operate in a consistent and predictable manner and the knowledge of such channel response to artificially placed structures must be used to select, design, and place improvement structures.

Rosgen's stream classification system, presented in Part III, provides a basis for evaluating instream structure suitability. A variety of commonly used structural enhancement designs that can be applied to a wide range of stream types are also presented in Part VII. The potential effectiveness guidelines for fish habitat improvement structures are based on morphology of the stream types involved. The guidelines are derived from actual observations of both good and poor applications of a given structure type in a particular stream type. They are only guidelines and are meant to provide general direction or highlight potential problems, and are not intended to be rigid dogma or to evolve into hard rules, and in no way substitute for the services of a qualified fisheries specialist or hydrologist in planning projects. The guidelines may, however, "red flag" some potential problem areas that require more detailed, site-specific analysis prior to structure selection. The rating categories for suitability are excellent, good, fair, and poor. These ratings do not reflect 1) the biological effectiveness for meeting limiting habitat factors in any particular stream, 2) costs or difficulty of construction, or 3) cost/benefit relationships.

CALIFORNIA SALMONID STREAM HABITAT RESTORATION MANUAL

PROJECT RECOMMENDATION DEVELOPMENT FROM HABITAT INVENTORY DATA

Every stream inventory report based on DFG format contains general recommendations for fish habitat improvements, or further assessment needs.

- 1) Management as an anadromous, natural production stream.
 - a) Management as an anadromous, natural production stream includes all streams and stream reaches that currently support anadromous fish, or are restorable to do so. These streams, reaches, and naturally reproducing stocks provide the foundation of the DFG salmon management program.
 - b) In some cases cooperative fish production is desirable if the fish rearing facilities are linked to restoration goals and objectives approved by the Department. Hatchery enhancement programs are reviewed carefully by DFG Regional and IFD personnel. These programs must have a five-year management plan that shows a clear need, a specific purpose and benefit, and scientific justification.
- 2) Design and engineer pool enhancement structures to increase the number of pools or deepen existing pools, where the banks are stable or in conjunction with stream bank armor to prevent erosion.
 - a) In general, pool enhancement projects are considered when primary pools comprise less than 40 percent of the length of total stream habitat. In first and second order streams, a primary pool is defined as having a maximum depth of at least two feet, occupy at least half the width of the low flow channel, and be as long as the low flow channel width. In third and fourth order streams, a primary pool must be at least three feet deep.
 - b) In the Part III section, “Stream Channel Type Descriptions and Structure Suitability,” specific structure recommendations are included for each channel type. Instream habitat improvement is only appropriate in stream reaches suitable for habitat improvement structures.
 - c) In Part V, Table 2, “Summary of Habitat Types and Measured Parameters,” found in the stream inventory report lists the Level IV habitat types for the stream inventoried. Habitat types such as step runs and low gradient riffles can often be converted into pool habitat if pools are needed.
 - d) Table 4, Part V, “Summary of Maximum Pool Depths By Habitat Types,” found in the stream inventory report lists the depth of the pools by habitat type. Pools too shallow to qualify as primary pools can often be enhanced by increasing scour.

CALIFORNIA SALMONID STREAM HABITAT RESTORATION MANUAL

- e) In Part VI, “Project Planning and Organization,” and Part VII, “Project Implementation,” must be thoroughly reviewed before proceeding with a pool enhancement project.
- 3) Increase woody cover in the pool and flatwater habitat units, with complex, woody cover, especially where the material is locally available.
- a) In streams or stream reaches where the mean pool shelter ratings are calculated to be less than 80 it is desirable to increase the amount of cover. Part V, Table 1, “Summary of Riffle, Flatwater and Pool Habitat Types,” lists the mean shelter ratings for the Level II habitat types. Log and root wad cover structures in the pool and flatwater habitats are needed to improve both summer and winter salmonid habitat. Log cover structure provides rearing fry with protection from predation, rest from water velocity, and also divides territorial units to reduce density related competition. Part V, Table 5, “Summary of Mean Percent Cover By Habitat Type” identifies the type of cover by habitat type present.
 - b) In the “Stream Channel Type Descriptions and Structure Suitability” section of Part III, includes specific structure recommendations for each channel type. Cover structures should only be considered in stream reaches suitable for habitat improvement structures.
 - c) Part VI, “Project Planning and Organization,” and Part VII, “Project Implementation,” must be thoroughly reviewed before proceeding with a cover enhancement project.
- 4) Increase canopy by planting willow, alder, or native conifers along the surveyed stream banks where shade canopy is not at acceptable levels, or in reaches above the survey section when temperature impacts have originated upstream. Planting must be coordinated with bank stabilization and/or upslope erosion control projects.
- a) Where summer water temperatures are above the acceptable range for salmonids (Appendix P) increasing the canopy is desirable. Water temperatures taken during the fish habitat inventory are found in Part V, Table 8, “Fish Habitat Inventory Data Summary”. Some reports also contain more extended recording thermograph data.
 - b) In general, revegetation projects are considered when canopy density averages less than 80 percent in specific steam reaches or sub-areas. Canopy density, listed by the coniferous and deciduous components is found in Part V, Table 8.

CALIFORNIA SALMONID STREAM HABITAT RESTORATION MANUAL

- c) The mean percentages of the right and left banks covered with vegetation are found in Part V, Table 7, “Summary of Mean Percent Cover For The Entire Stream”. The mean percentages of dominant substrate and dominant vegetation are found in Part V, Table 9. Using these two tables, stream reaches can be identified where the dominant elements composing the structure of the stream banks are silt, clay, sand, or gravel, and riparian vegetation is lacking. These areas are good candidates for revegetation.
 - d) The “Revegetation” section of Part VII contains detailed instructions on techniques including willow sprigging and planting seedlings.
- 5) To establish more complete and meaningful temperature regime information, twenty-four hour monitoring during the warm summer water temperature season should be conducted for a period of three to five years.
- a) This recommendation is made when limited water temperature data are available, but either the survey samples or short-term thermograph data suggests that maximum temperatures are likely to be above the acceptable range for juvenile salmonids. These streams or reaches are usually candidates for revegetation.
- 6) Inventory and map sources of stream bank erosion and prioritize them according to present and potential sediment yield. Identified sites should then be treated to reduce the amount of fine sediments entering the stream.
- a) Bank erosion sites are listed in the “Comments and Landmarks” section in the stream inventory reports.
 - b) The “Watershed and Stream Bank Stability” section of Part VII, details many techniques for treating stream bank erosion.
- 7) Active and potential sediment sources related to the road system need to be identified, mapped, and treated according to their potential for sediment yield to the stream and its tributaries.
- a) Sediment related to roads impact cobble embeddedness. These values are summarized in Part V, Table 8. Cobble embeddedness measured to be 25 percent or less, a rating of 1, is considered to indicate good spawning substrate for salmon and steelhead. Road systems have been attributed to generate as much as 70 percent of the sediment yield produced in most watersheds. Part VI, “Upslope Watershed Treatments,” includes information on potential actions to identify and reduce upslope sediment.
- 8) Projects should be designed at suitable sites to trap and sort spawning gravel in order to expand redd site distribution in the stream.

CALIFORNIA SALMONID STREAM HABITAT RESTORATION MANUAL

- a) Projects to increase spawning gravel are desirable where suitable spawning gravel is found on relatively few reaches, or crowding and/or superimposition of redds has been observed during winter surveys.
 - b) When a large percentage of the low gradient riffles has substrate other than gravel or small cobble as the dominant substrate, gravel trapping structures may be considered. Part V, Table 6, "Summary of Dominant Substrates By Habitat Type," has the summary information about the stream substrate.
 - c) The "Stream Channel Type Descriptions and Structure Suitability" section in Part III, makes specific structure recommendations for each channel type. Instream habitat improvement structures should only be considered in suitable stream reaches.
 - d) Part VI, "Project Planning and Organization," and Part VII, "Project Implementation," must be thoroughly reviewed before proceeding with instream structures to enhance spawning substrate.
 - e) A stream reach located below a dam or other gravel supply restriction may need spawning gravel replenished. The "Placement of Imported Spawning Gravel" section of Part VII, has recommendations for this treatment.
- 9) Modification of log debris accumulations is desirable, but must be done carefully, over time, to avoid excessive sediment loading in downstream reaches, and to preserve the larger beneficial scouring elements.
- a) Log debris accumulations (LDA's) are listed in the stream inventory report in the "Comments and Landmarks" section.
 - b) A log debris accumulation should only be modified if it is retaining a significant amount sediment, and the biological inventory confirms it is creating a fish passage problem, or the LDA is causing to significant bank erosion.
 - c) In Part VII, "Fish Passage," methods are detailed for modifying fish passage.
- 10) Fish passage should be monitored and improved where possible.
- a) High gradient streams or streams containing an >A= or >G= type channel, or streams with high gradient riffles, cascades or bedrock sheets as habitat types may limit fish passage, especially in years with limited rainfall. Good water temperature and flow regimes and suitable habitat for rearing fish must exist upstream for this to be a concern.
 - b) In some streams selective barriers exist. For example, a stream could have a barrier to coho but not steelhead. Selective barrier conditions must be confirmed with a biological inventory.

CALIFORNIA SALMONID STREAM HABITAT RESTORATION MANUAL

- c) Before any barrier modification is undertaken, the DFG District Biologist must be consulted to determine if modification of the barrier is desirable and to confirm the status of resident stocks in order to avoid impacting the genetic integrity of existing or native stocks.
 - d) The “Waterfalls and Chutes” section of Part VII details methods for improving fish passage through these areas.
- 11) Culvert modification or replacement.
- a) Culvert types, dimensions, condition, and the height of the jump into the culvert are listed in the stream inventory reports in the “Comments and Landmarks” section.
 - b) Replacing a culvert with a bridge is desirable when a high jump and/or the velocity of the water in a culvert, makes the culvert a probable fish migration barrier.
 - c) A culvert that is adequately sized, in good condition, and accessible to anadromous fish, may benefit from the installation of baffles. The “Culverts” section of Part VII has several examples of baffle installation. Culverts should only have baffles installed after consulting with a qualified engineer.
 - d) In some cases, culverts have been installed too high to allow anadromous fish to jump into the culvert. If the culvert cannot be replaced with a bridge or with a new culvert below stream grade, it may be desirable to construct a fishway. Part VII, “Fishways,” has examples of commonly used designs. Prior to the construction of a fishway, a qualified engineer must design and engineer the project.
- 12) Exclusion of livestock from the riparian corridor except at controlled access points should be explored with the grazer and developed if possible.
- a) Areas where livestock are impacting the riparian zone are listed in the stream inventory reports in “Comments and Landmarks.”
 - b) The “Exclusionary Fencing” section of Part VII details some options for excluding livestock from riparian zones.

CALIFORNIA SALMONID STREAM HABITAT RESTORATION MANUAL

PROJECT SITE LAYOUT

Once the need for instream habitat improvements have been made, project sites located, and suitable enhancement structures selected, actual project layout must be developed. Hydraulic profiles for base flow, bankfull discharge, and flood flows should be developed at each project site, and a schematic display of proposed structure(s) and job site layout drawn. The drawing must include upstream and downstream limits of the project site, established cross sections, and a longitudinal profile. At the project site an elevation benchmark monument must be established and described. Triangulation, or the so-called “two-pin method” can be useful for layout of stream habitat enhancement designs and for establishing permanent reference points (Appendix L).

For evaluation and monitoring purposes, it is important to accurately record and monument the project location, and describe and record pre-treatment conditions at the site. Identify and monument photo points, describe the camera location and angle for the photo, and record the type of camera and lens used. Accurately measure the location of the project benchmark monument from a fixed, easily identified landmark such as a permanent bridge, confluence with a blue line or named tributary, or the stream mouth. Determine the latitude and longitude of the project from a USGS 7.5-minute quadrangle using the Coordinator tool or an accurate GPS location. If the stream has been habitat typed, record the habitat unit number from the survey. Finally, be sure to include access routes to the project, noting any special considerations like locked gates, or requirements from landowners.

Using Basic Hydraulic Analysis For In-Channel Design

Addition or removal of gravel, boulders, structures, vegetation etc., within a stream channel alters its existing cross-sectional shape. Furthermore, when material is added or removed from a stream channel it changes the channel's ability to convey water and sediment. Designers should carefully consider effects these alterations have on local channel geometry. For example, addition of a wing-deflector typically narrows the cross-section, resulting in some backwater and increased erosional force. Channel-form changes and deposition in the vicinity of the structure can be anticipated through basic hydraulic analysis.

The following channel assessment method (adapted from Inter-Fluve, Inc. 1984) is based on formal hydraulics and can help determine dimensions, locations and elevations of channel modifications. The method requires hydraulic data collection, (longitudinal and cross-sectional elevations) and interpretation of these data (drafting and analysis of longitudinal and cross-sectional elevations). Designs are developed for individual sites by subjecting specific cross-sections to hydraulic analysis. After the design is developed on paper, it can be constructed according to criteria generated (new longitudinal and cross-sectional elevations).

CALIFORNIA SALMONID STREAM HABITAT RESTORATION MANUAL

Surveying the Longitudinal and Cross-Sectional Profiles

Longitudinal and cross-sectional information is gathered to identify elevation of the stream bottom and various water levels. By convention, longitudinal profile is surveyed along the thalweg at locations where pronounced changes in bed slope occur. Cross-sectional profiles are surveyed at specific sites along the longitudinal profile to highlight special features.

Longitudinal distance markers (station, river mile, etc.) should be established systematically, usually every 100 feet, along the right or left bank, as you face downstream, with tagged rebar or wooden stakes. By convention, distance is measured from the start of the reach upstream; also, the first station is normally located at a reproducible location such as a bridge pier, culvert, or tributary junction. Distance of each pool and riffle feature is then recorded. For example, the first unit in the longitudinal profile, a riffle, may extend from 0' to 55', and the first pool from 55' to 75'. Distance surveyed should not only include the reach of stream under investigation but also several pool/riffle sequences, upstream and downstream. Elevation data are gathered by standard surveying techniques, with particular attention to changes in the streambed and major longitudinal slope breaks. Identifying these breaks in slope can be difficult, but often pools usually require a minimum of five longitudinal readings, while riffles tend to be more consistent and may only require three readings. Of course, complex streams may require more frequent readings. Figure VI-1 depicts a longitudinal profile and its various features; of special interest is the location of elevation shots and their importance in characterizing stream channel shape.

Cross-sections are recorded at specific locations along the longitudinal profile. This information is usually gathered at the time of the longitudinal survey, but additional sites may be surveyed later. For a given reach, cross-sections should be measured at both riffles, runs and pools. These data are gathered for two basic purposes: 1) to describe a location in elevational form which you wish to emulate or use as a reference cross-section; and 2) to describe a location in elevational form which you wish to alter or use as a potential design site. Elevation data in cross-sectional form are very important to hydraulic calculations.

Number and location of appropriate measurements must be subjectively determined in the field based on natural stream variability. Measurement techniques for either pool or riffle cross-sections are the same (Platts et al. 1987). Cross-sectional profiles for any particular location should include left and right bank elevations, floodplain elevation(s), intermediate channel to bank elevations, and estimated bankfull discharge water surface elevation (even if this elevation must be intuitively reasoned). Again, complex channels will require more elevation recordings.

To adequately describe a location in numeric form may require establishing a number of cross-sections. The large variation inherent in pools normally requires three cross-sections to adequately describe a single location. These measurements should be taken at the entrance to the pool, through the deepest part of the pool, and at the pool exit or tail-out. In contrast, riffles exhibit less variation and usually require less intensive measurement. After the longitudinal and cross-section elevation data are gathered they should be plotted (Figures VI-1 and VI-2).

CALIFORNIA SALMONID STREAM HABITAT RESTORATION MANUAL

Graphically displaying the profiles allows the designer to identify pool, run and riffle features and determine site specific hydraulic variables. Figure VI-2 depicts a series of cross-sectional profiles (reference cross-sections) and their various features; of special interest is the location of elevation shots and their importance in characterizing stream channel shape.

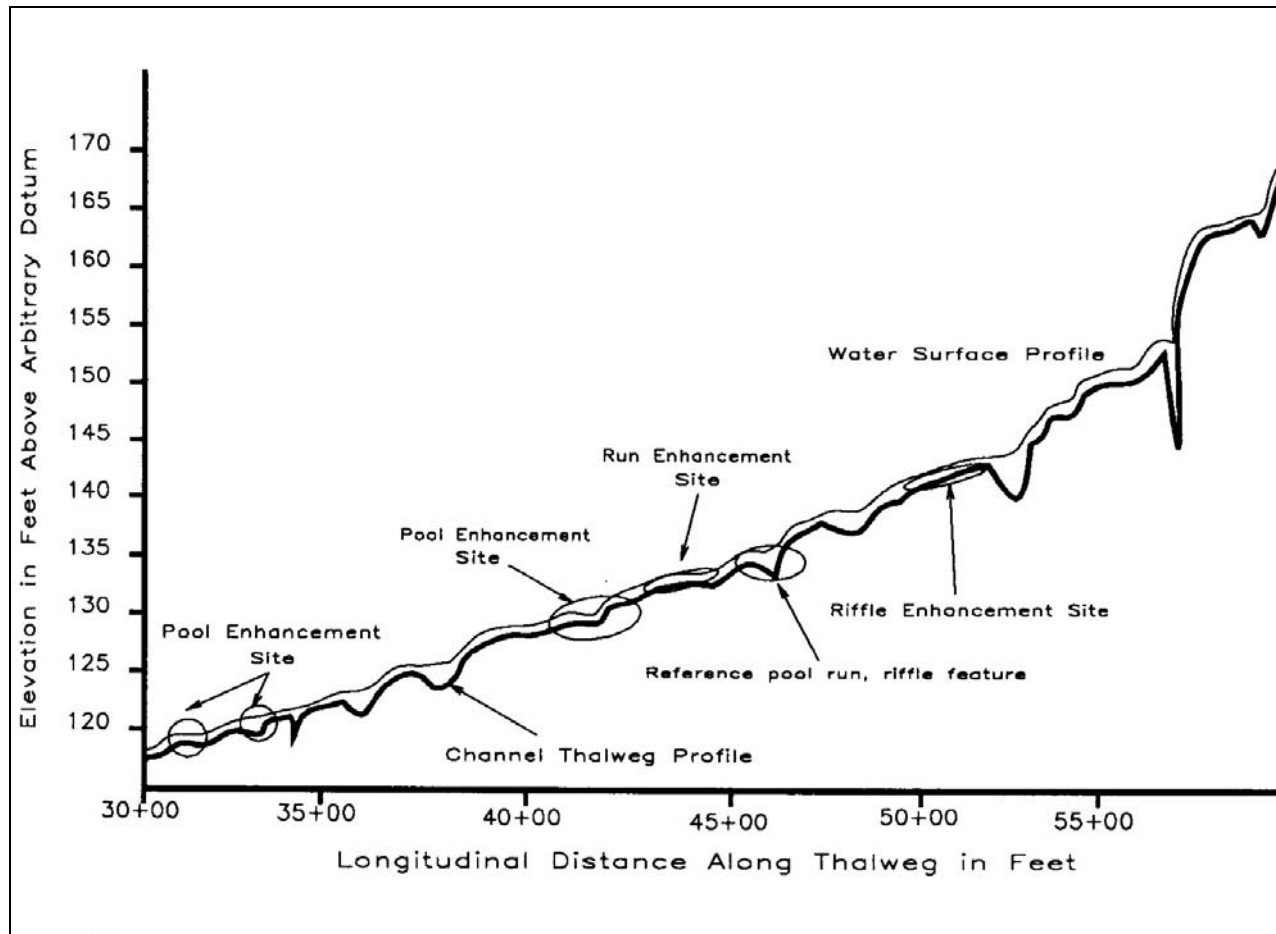

Figure VI-1. Longitudinal profile of channel bed depicting locations of possible enhancement sites.

CALIFORNIA SALMONID STREAM HABITAT RESTORATION MANUAL

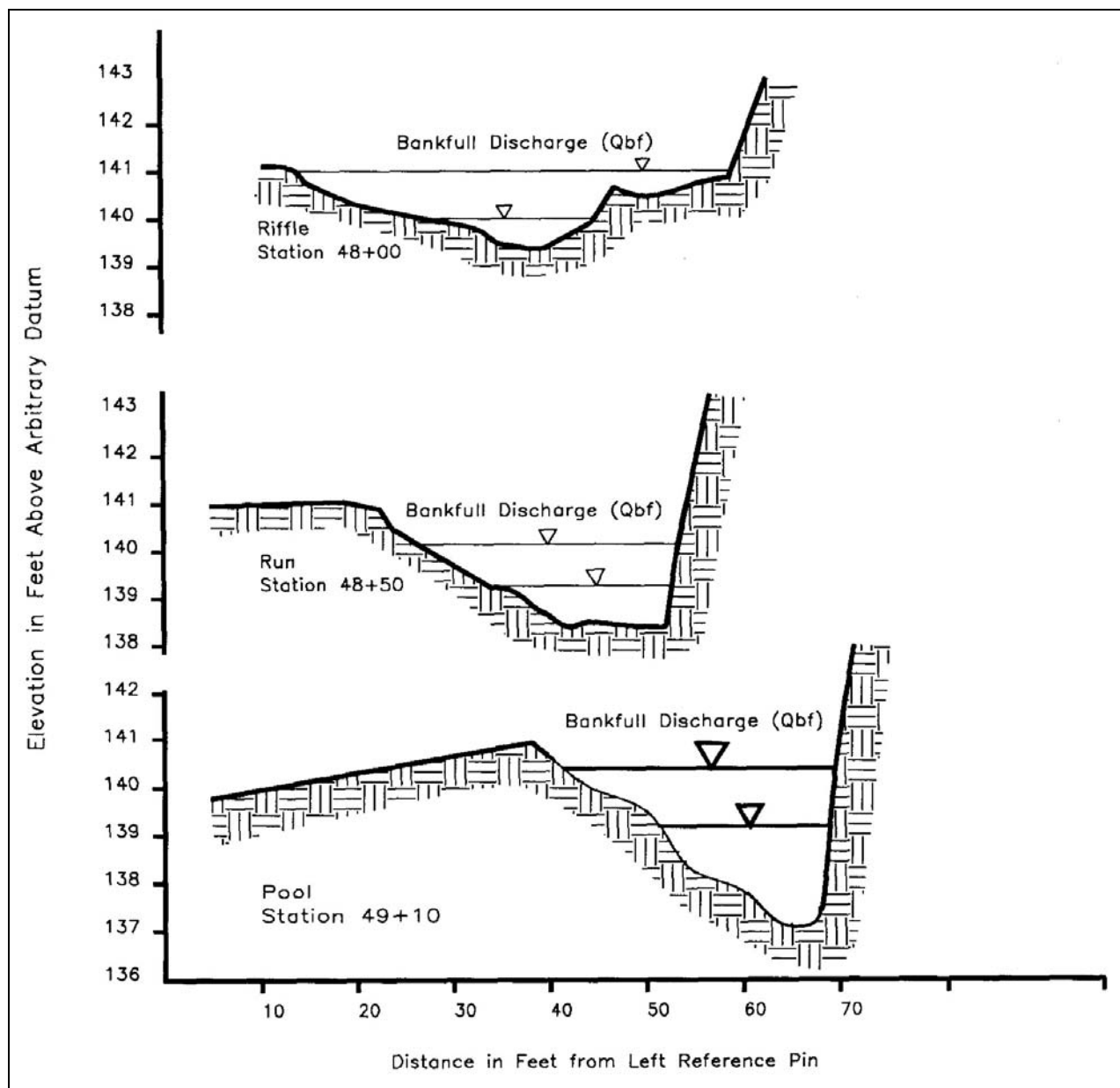

Figure VI-2. Selected cross-sectional profiles for reference pool, run, riffle features.

Analysis of Longitudinal Profile

The longitudinal profile is the most important tool in determining location of channel enhancement opportunities. The profile depicts existing features that reflect past geomorphic channel activity. Visual analysis will show depths of various pools, length of riffles, locations of runs and transitions. Pools and runs are most often found at localized slope breaks, i.e., steep slope changing to a shallow downstream slope. In general, the magnitude of these slope breaks determines energy available for sediment scour or fill. Energy expenditure is ultimately manifested in depth of water in the pool or run. Deeper pools are often found below steeper riffles; conversely, shallow pools or runs are most often found below less dramatic breaks in slope.

CALIFORNIA SALMONID STREAM HABITAT RESTORATION MANUAL

One should keep in mind that longitudinal information supplements other field observations, such as location of a bedrock bank, sudden change in stream direction, or instream roughness objects. Slope breaks are tools that designers can use to plan locations of channel alterations.

Enhancement is most often directed toward modifying transitional areas that appear from the data to be poorly developed pools, riffles or runs. For example, if the focus is on developing better pools, the first task is to look at the longitudinal profile and identify conditions depicting exemplary pool habitat. Factors to characterize might include slope and length of the upstream riffle, slope and length of the downstream riffle, and slope and length of the existing pool. This exemplary pool habitat characterization, when combined with other field data (e.g. location of a bedrock bank, sudden change in stream direction, or instream roughness objects), provides the designer with a "reference profile template" for pool habitat. Once a reference profile template is developed, potential enhancement sites can be located by fitting the template into existing conditions. A reference pool template will normally best fit areas which are "tending to be pools." Similarly, a reference run template will best fit areas which are "tending to be runs," and reference riffle templates will fit areas which are "tending to be riffles." With suitable templates, enhancement involves modifying existing conditions to emulate the reference template exhibiting desired habitat.

From the viewpoint of hydraulics, the most useful longitudinal templates are ones that can be described mathematically. In order to extract a mathematical template from the longitudinal profile, it is necessary to calculate average slope of the reach, or various specific segments. This task is accomplished by fitting a straight line between upstream and downstream elevations on the profile. The slope of the resulting line is calculated by dividing vertical change in elevation by longitudinal distance. Slope is also calculated for short segments, such as that which might be used for site-specific templates, or for somewhat longer distances, such as average slope for a particular reach within the overall profile. Both average slope of the longitudinal profile, and shorter segment slopes have utility and are used in hydraulic calculations discussed below.

Analysis of Cross-Sectional Profiles

Cross-sections provide the designer with an in-depth look at existing conditions, provide mathematical templates (reference cross-sections) for exemplary habitat types and also serve as guides for construction of restoration features. Two types of cross-sectional profiles are analyzed: 1) cross-sections for use as reference cross-sections (exemplary habitat types); and 2) cross-sections which you wish to alter (potential design sites). Items of particular interest, in addition to the actual cross-sectional configuration, are estimated bankfull discharge, mean annual discharge, bed and bank substrate types, location of large woody debris, stability of bank and floodplain vegetation, slope and length of upstream riffles, slope and length of downstream riffles, and slope and length of pools for each type of cross-section. Again, similar to the longitudinal profile, cross-sectional profiles should supplement/support other field data.

CALIFORNIA SALMONID STREAM HABITAT RESTORATION MANUAL

Cross-section profiles selected for restoration should be plotted on a design sheet. Similarly, reference cross-sections should also be plotted to provide the designer with cross-sectional templates. Comparison of reference cross-sections with a location under consideration for restoration can be particularly informative in regard to different channel configurations. During the initial comparison process, designers should pay careful attention to other field data, as many factors not accounted for on the reference template may influence its shape. Ultimately, a suitable reference cross-section(s) is selected as a restoration goal for a specific cross-section profile(s) that has been selected for restoration.

Selection of a suitable cross-section reference template to be used as a guide for alteration of a selected cross-section profile must be done carefully. Again, similar to longitudinal profile templates, reference pool cross-section templates will best fit areas which are "tending to be pools". A reference run cross-section template will best fit areas which are "tending to be runs," and reference riffle cross-section templates should fit areas which are "tending to be riffles." Each cross-section profile selected for restoration is paired to a specific reference cross-section. By carefully selecting suitable templates, enhancement of a chosen cross-section involves modifying its configuration to emulate its paired reference template. Modification of the cross-section selected for restoration is guided by using an iterative hydraulic analysis known as the Manning Equation (Appendix H).

CALIFORNIA SALMONID STREAM HABITAT RESTORATION MANUAL

REFERENCES

- Inter-Fluve, Inc. 1984. In-house computer design program for in-channel modifications.
Inter-Fluve, Inc. Bozeman, MT.
- Platts, W.S., D. Armour, G.D. Booth, M. Gryant, J.L. Bufford, P. Cuplin, S. Jensen, G. W. Lienkaemper, G.W. Minshall, S.B. Monsen, R.L. Nelson, J.R. Sedell, and J.S. Tuhy. 1987. Methods For Evaluating Riparian Habitats With Applications To Management. United States Department of Agriculture, Forest Service General Technology Report INT 221.
- McEwan, D. and T.A. Jackson. 1996. Steelhead restoration and management plan for California, Calif. Dept. of Fish and Game, Sacramento. 234 pp.

CALIFORNIA SALMONID STREAM HABITAT RESTORATION MANUAL

PART VII

PROJECT IMPLEMENTATION

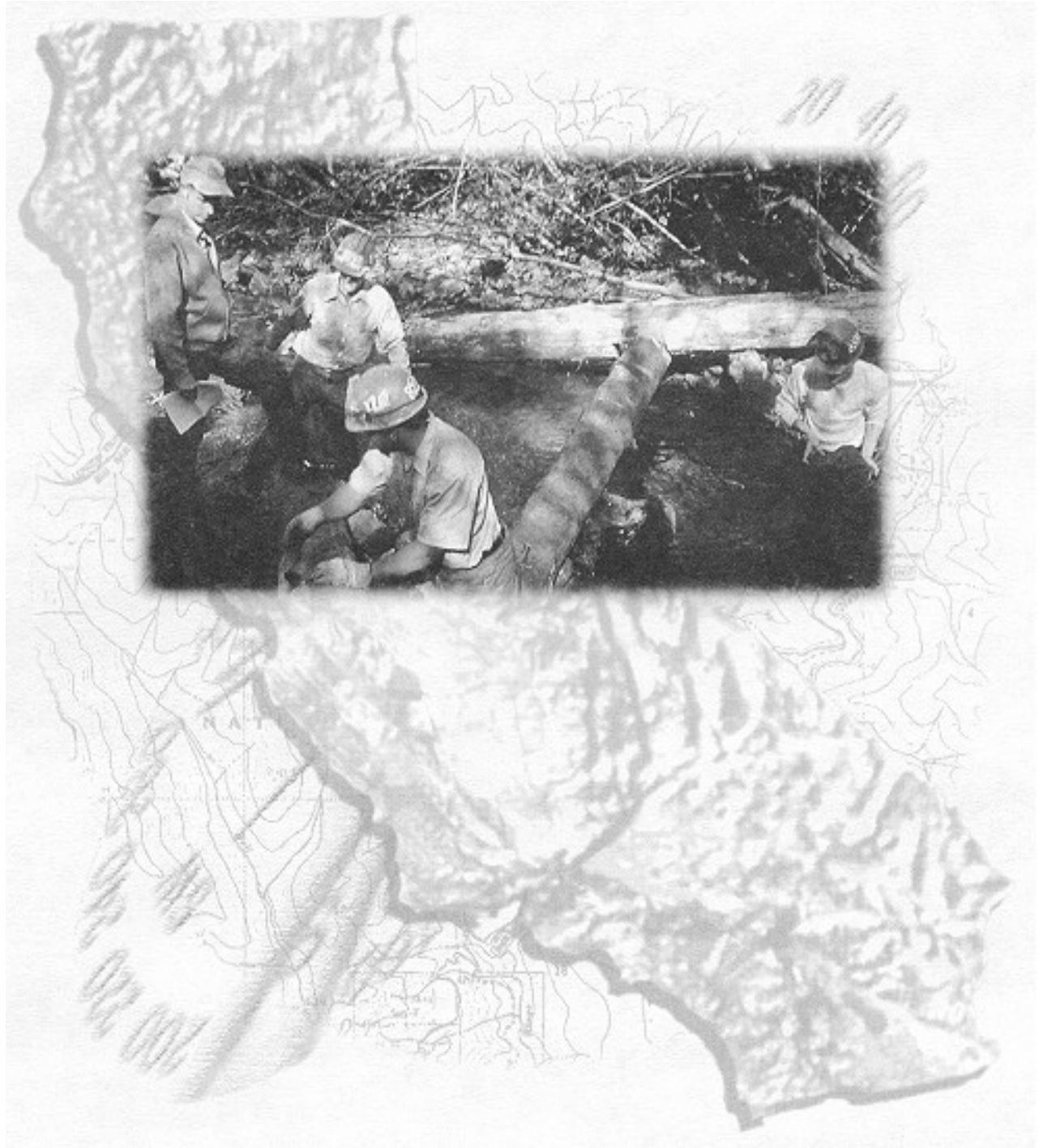

CALIFORNIA SALMONID STREAM HABITAT RESTORATION MANUAL

PART VII PROJECT IMPLEMENTATION

When critical habitat has been determined to be lacking, placement of suitable structures or other remedial actions may be appropriate. If structural options are selected, some essential physical parameters must be considered. Project location and access, available structural materials, stream flow volume and velocity, current and expected land use practices, watershed stability, stream channel and bank stability, and bedload and debris transport are basic parameters that must be considered before instream improvement structures are installed. Hydraulic cross sectional analysis should always be performed to assure passage of bankfull flows.

Kinetic energy of a stream determines its ability to move materials. Maximum kinetic energy is generated during bankfull flow, usually related to storms. Bankfull flows may also occur because of released storage in regulated streams. It is during these bankfull flow events that maximum bedload transport and channel formation occurs. As flows subside, deposition and additional stream channel forming processes occur.

Numerous factors including watershed condition, channel configuration, and instream structure regulate bedload transport through a system. The coupling of water energy and bedload limits the opportunities for placement of stable fish habitat structures.

SELECTION OF STABLE SITES

Stable habitat restoration sites with appropriate hydrologic channel characteristics afford the greatest opportunity for successful structure installation. Review of site suitability for project work must incorporate an assessment of natural features of the stream. For example, observation of deposition and scour areas on stream banks will reveal the range of flows in the stream. At each potential structure site, the following factors should be analyzed to determine if a structure will be suitable, stable, and effective.

Gradient

For many structures, sites with gradients less than 0.5 percent or greater than four percent are poor candidates. Stream reaches with gradients of less than 0.5 percent are frequently depositional areas. Partial channel spanning structures that constrict flow such as single and opposing wing deflectors or constricting weirs, can be used to increase water velocities, creating habitat by deepening channels.

High gradient stream reaches greater than four percent are difficult to control. The substrate in these streams is often bedrock or boulder and usually lacks spawning gravel. Full channel spanning structures designed to trap gravel must be placed very close together to reduce the flushing effect of high stream flow velocity. Hydraulic forces present in excessively high gradient streams increase stress and the probability of structural failure, and reduces the number of alternative treatments and the chance of a project succeeding.

CALIFORNIA SALMONID STREAM HABITAT RESTORATION MANUAL

Stream Width

Sites in reaches that are slightly wider than mean stream width are the best candidates for successful channel spanning structures. Velocities in these areas will be lower than more constricted reaches, providing a natural energy control. However, overly wide channels will typically be areas of deposition and are unsuitable for other than channel constricting structures.

Substrate

Bedload deposition tends to occur in areas of mean stream width or wider. These areas provide the greatest opportunity for placement of substrate scour or deposition structures. Channel spanning structures may be placed to capture gravel or other bedload materials on the upstream side of the structure, and create scour downstream. A series of structures can redistribute bedload and create reaches containing gravel deposition, cover, and scoured pools. Free-standing structures are typically unstable because of periodic bedload movement associated with high flows.

Highly compacted substrate creates special construction problems for placement of instream fish habitat structures. Heavy equipment or specialized techniques may be required to securely anchor structures at these sites. For this reason, construction costs are often prohibitive and long term stability is uncertain.

Bedrock substrate provides a good anchor for instream structures using cable or rebar and polyester resin adhesive. The bedrock foundation for a stable structure must be un-fractured and durable.

Stream Order

Lower order streams, at appropriate sites, can usually be controlled with standard habitat restoration structures. Higher order streams typically have high stream power and require large construction materials and larger or more complex structures, making site selection even more critical.

Reach Length

Generally, a reach should be long enough so that structures can be placed in a series. When structures are placed in a series, the most upstream and downstream structures create velocity control points. These controls can be particularly important in areas where deposition of gravel is the purpose of the structure.

Channel Sinuosity

Sinuuous stream reaches are areas of scour and deposition. To be effective in these reaches, a structure must be fitted to the bend in the stream. For example, diagonal weirs located on a bend will trap gravel while downstream-V weirs at the same site generally will not. Generally, sinuous stream reaches are not desirable locations for structures built in a series.

CALIFORNIA SALMONID STREAM HABITAT RESTORATION MANUAL

Bank Stability

The choice of suitable structures is limited by the stability of stream banks at the site. For example, structures that direct flow into unstable banks will result in bank erosion and possible structural failure. Stable banks are essential to structural integrity in channel spanning structures.

Bank Morphology

Stability of habitat structures will be affected by stream bank morphology. Especially steep banks will result in rapidly rising stream surface elevation with increased flows overtopping installed structures. Unconfined stream banks will result in rapid widening of the stream, with increased flows potentially relocating the stream channel and circumventing the structure. Bedrock or well consolidated stream banks provide a stable base for structure placement, whereas poorly consolidated stream banks require riprap or other durable material for protection.

The extent to which boulders and woody structures protrude from the stream bank into the channel will provide a reasonably good guideline for placement of stream bank associated habitat structures. For comparative purposes, look at natural channel features that presently produce habitat similar to that which needs to be increased. Projects should use successful natural features as guidelines for design and location of structures whenever possible.

HYDRAULIC IMPACTS

A familiarity with the principles of stream hydraulics is important when designing site specific instream habitat enhancement structures because it is necessary to predict hydraulic impacts of each project to ensure that it will achieve the desired result. Inter-Fluve Inc. has developed a method for predicting hydraulic impacts, "Using Basic Hydraulic Analysis for In-Channel Design" (G. Koonce and M. Kiese, Inter-Fluve Inc., personal communication). However, due to the myriad of factors affecting streams it remains difficult to measure and predict the precise outcome of a new structure to a stream. Evaluation of each project site for successes, failures, and causes is useful for developing skills of selection, design, and construction of habitat improvement structures.

For any single structure such as a diagonal log weir, the location of stream scour and deposition is relatively predictable. As structures become more complex, or a series of structures is developed, scour and deposition becomes more difficult to predict.

Scour is predictable at four locations in a stream: on the outside of bends, below waterfalls or cascades, at a constriction, or at a steepened gradient. The amount of scour generated by a structure has built-in limitations controlled by the kinetic energy budget of the stream.

Similarly, deposition can be predicted at three locations in a stream: on the inside of bends, in quiet water areas such as eddies where stream energy has been dissipated, and on the upstream side of natural sills or structures where flow is obstructed.

CALIFORNIA SALMONID STREAM HABITAT RESTORATION MANUAL

Height of a structure or relative radius of a bend influences the amount of scour or deposition. For example, stream flow and energy gradient, combined with effective height of a structure will dictate the depth of scour. In general, the higher the structure the deeper the plunge, up to the point of energy limitations (Figure VII-1). The need for upstream migration of adults or juveniles is a very important consideration when deciding how high to build a structure. Jumps in excess of 12 inches are to be avoided. If the gradient of the stream dictates a structure of over 12 inches in height, a low-flow notch at the thalweg is required to improve upstream migration for juveniles.

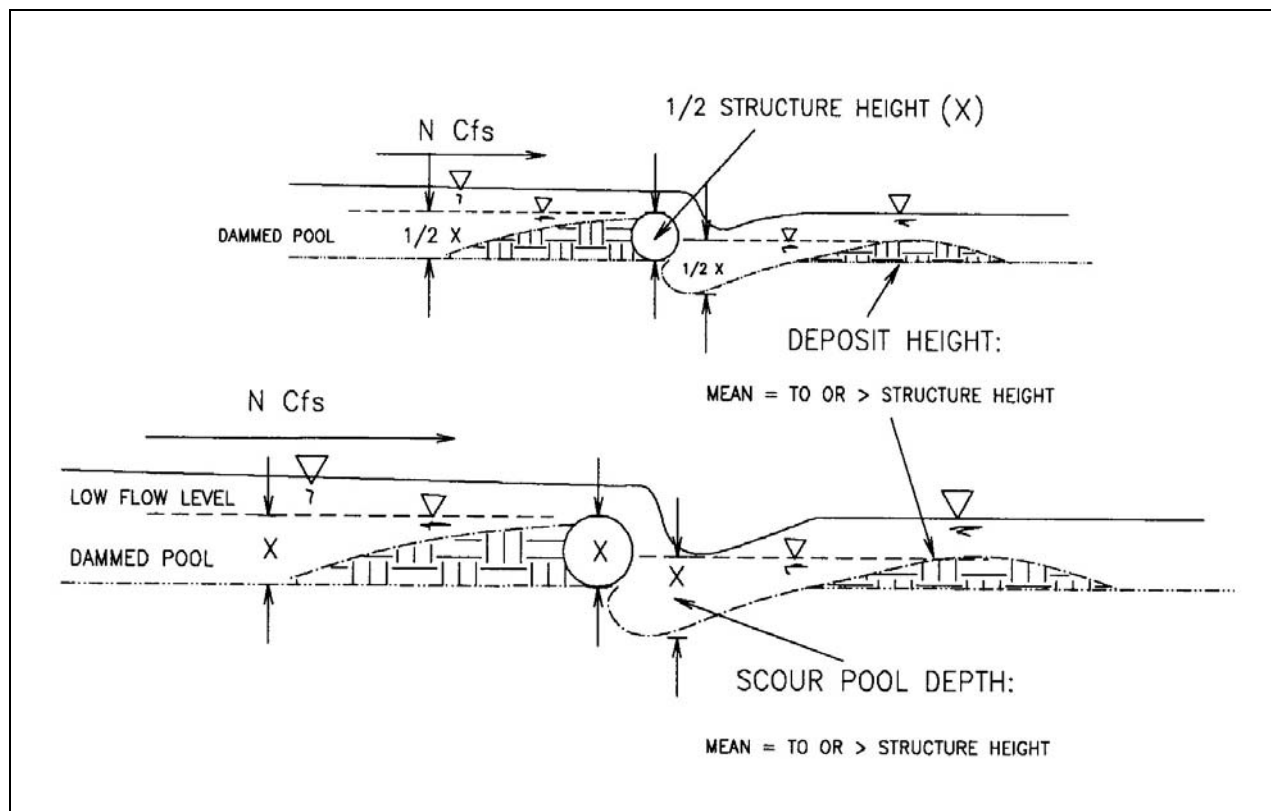

Figure VII-1. Typical structures of variable height in the same stream reach create pool depths and deposition heights directly related to structural heights (Anderson, 1988).

Without attempting formal hydraulic engineering analysis, observation of an existing structure in a stream will give a good indication of the scour that can be expected for a similar structure. Structures that obstruct flow tend to produce bars downstream that are nearly as tall as the structure.

Where water overtops a structure, the vertical angle of the downstream face strongly influences potential stability of the structure by directing the impact of the plunge flow. A vertical face will result in scour directly at the toe and may undercut the structure. With some designs of log structures this may be desirable but for boulder structures in deep alluvial streams this may result in structure failure. Undercutting can be avoided by placement of downstream rows of successively deeper boulders to provide a sloping face (Figure VII-2) that directs plunge flow away from the structure.

CALIFORNIA SALMONID STREAM HABITAT RESTORATION MANUAL

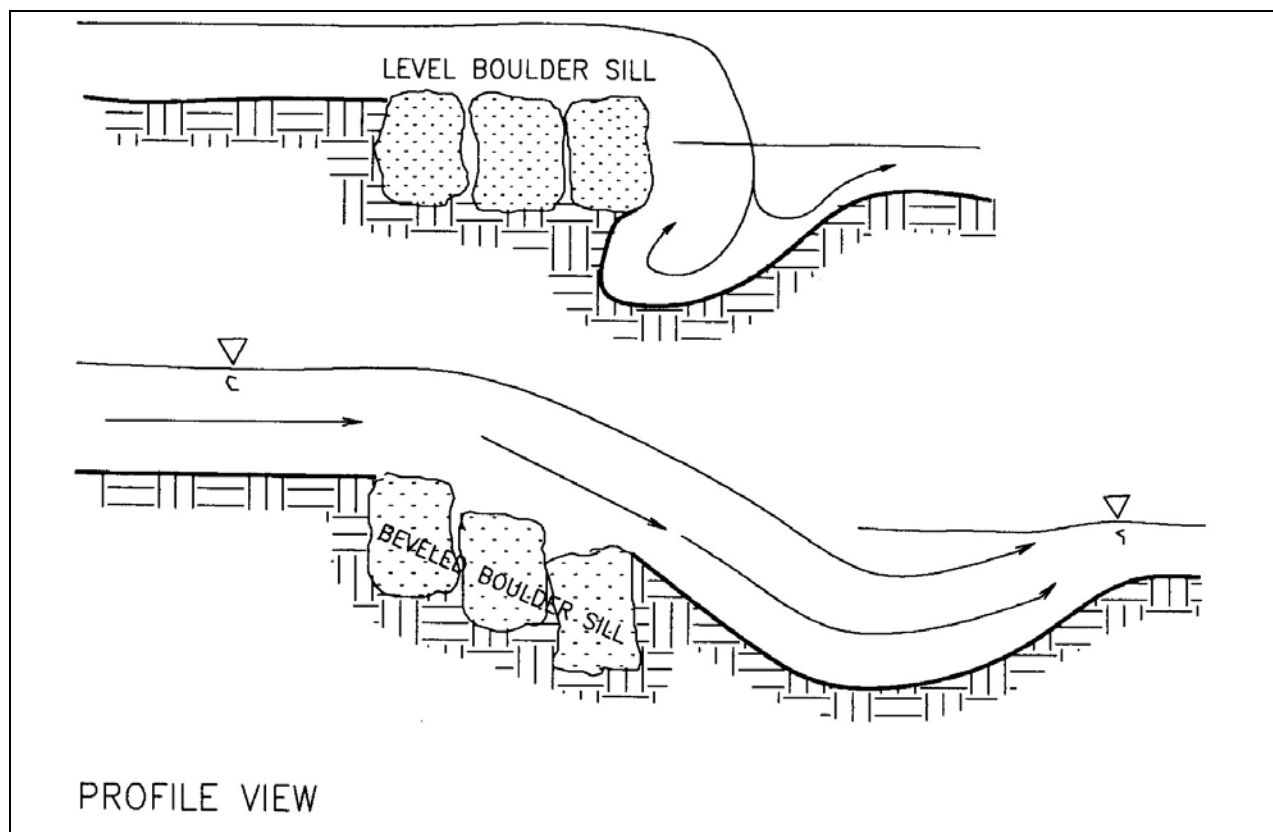

Figure VII-2. Comparison of level and sloping boulder face affect on flow into plunge pool (Overton, 1987).

Length of a full-spanning structure relative to the perpendicular stream width affects the stream's energy budget above and below the structure. Structures perpendicular to flow, such as straight log weirs, generally increase velocities because they narrow the high-flow channel. This happens because of the constriction created by the anchoring structures required to protect the ends of the weir. Structures such as diagonal log weirs that are two to three times the mean stream width will widen the hydraulic cross section, thus decreasing velocities.

Structures placed level on stream grade will produce even cross-sectional flows with very predictable deposition areas above and below the structure. Structures of irregular heights will break up these even flows and produce irregular scour and deposition areas. Although structures of irregular height are not as stable as those placed level, they can enhance salmonid spawning and rearing by increasing diversity of cover in the form of turbulence and scoured pools. The simpler the design the more likely it will be that hydraulic impacts can be forecast. It is more difficult to reliably predict the outcome of complex structural arrangements largely because of multiple and unequal flow vectors generated.

Channel constrictions are common natural occurrences and can be easily duplicated with structures. Bedload is moved through the constricted area and scour is created and maintained within the constraints of the available kinetic energy budget. Structures such as upstream-V weirs, and single and opposing wing-deflectors are examples of channel constrictors. A channel can also be widened to spread out the flow and diminish concentration of energy. This usually will result in

CALIFORNIA SALMONID STREAM HABITAT RESTORATION MANUAL

channel aggradation. Downstream-V weirs and diagonal weirs are common structures for this purpose.

Multiple structures placed in a stream reach or complex structures such as log, root wad, and boulder combinations can create complex habitat with a wide variety of habitat niches.

SELECTION OF MATERIALS

The site often dictates which types of materials and which techniques must be used to successfully accomplish a stream habitat enhancement project. Selection of materials should come only after considering all factors. Factors to consider include:

- What are project objectives?
- What are funding limitations?
- What is expected life of the structure?
- What materials are on-site or nearby?
- If materials must be imported, are they economically available in adequate quality and quantity?
- Can the material of choice successfully be held in place during a major hydrological event?
- Will placement of enhancement structures require mechanized equipment, a large work crew or a combination?
- Are there access roads to the project site or a feasible way to get equipment and materials to the stream?
- Are the materials of choice aesthetically acceptable?

These considerations, together with the following information should be useful for choosing appropriate materials for fish habitat improvement structures.

Basic Structural Materials

Gabions

Gabions are heavy wire-mesh baskets that are filled with rocks or other hard material. They have been used to build instream structures such as weirs and wing deflectors. After several years, the wire mesh typically deteriorates due to abrasion, leaving broken and protruding wire from the disintegrating baskets. This creates a hazard to fish and humans. DFG recommends that gabions never be used within the flood prone area. Gabions can be useful as buried dead man anchors.

CALIFORNIA SALMONID STREAM HABITAT RESTORATION MANUAL

Gabion wire baskets are formed using the wire ties provided with the gabions. The empty gabions are firmly anchored and filled with rock. It is best to use angular, durable, un-fractured rock with a flat side facing the exterior of the gabion. When more than one gabion is used, secure the gabions together with heavy wire.

Logs

Logs can be used individually, or in combination with other logs, root wads, or boulders. Longevity is highly dependent on the tree species and percentage of time that the log is saturated. Redwood, western red cedar, Port Orford cedar, and Douglas fir can be expected to last the longest. Spruce, hemlock, white fir, pine, and hardwoods are least durable. The longevity of most logs can also be increased by removing their bark. Logs are buoyant and will float if not secured or weighted down adequately.

Logs can be used for a variety of applications: weirs, wing-deflectors, digger logs, cover structures, cribbing, and bank armor. Full-channel log structures are susceptible to washout or destabilization during periods of high stream flow if not adequately secured.

Root Wads

A root wad with an extensive root network can provide complex fish habitat throughout the year depending on where it is placed. Root wads can be anchored in a variety of locations including mid-channel, at the stream margins, or in pools, to enhance summer and winter habitat. Root wads with a long section of log intact are most valuable since they are easier to secure in place. Root wads must be well secured, preferably to bedrock, boulders, or stable logs.

Boulders

Competent boulders can be used in a variety of applications. They are especially suited for instream structures including weirs, wing-deflectors, and boulder clusters. Boulders are used extensively as riprap to stabilize failing stream banks. Logs, root wads, and boulders are often used in combination to form cover structures.

Boulders are among the most aesthetically pleasing of all stream enhancement structural materials. It is often difficult to tell whether their presence or arrangement is natural, or the product of habitat improvement efforts. Stream size does not limit their suitability. In wide stream channels, boulder weirs are more stable than log weirs because of the tendency for logs to float and disassemble.

The ideal situation is to locate a source of boulders close to the work site. The boulders must be of appropriate size, only use boulders that are as large or larger than those already in the stream channel. They must also be available in adequate quantity, and be un-fractured so they will withstand rough treatment during loading, unloading, and placement. Highly durable boulders are essential if cable and polyester resin adhesive are used to secure the boulders.

CALIFORNIA SALMONID STREAM HABITAT RESTORATION MANUAL

Angular quarry boulders are more stable under high stream flow conditions than round stream boulders. Burying approximately one-third of a rounded boulder into the substrate can help compensate for this drawback. Boulders should not be taken from the streambed if their removal decreases existing suitable habitat.

Boulder weights can be estimated by the size of the boulder. The following table estimates the weight of a boulder as approximately 150 pounds per cubic foot.

<u>Diameter (feet)</u>	<u>Volume (cubic feet)</u>	<u>Weight (lbs)</u>
2.0	4.2	627
2.5	8.2	1224
3.0	14.1	2115
3.5	22.4	3359
4.0	33.4	5014
4.5	47.6	7139
5.0	65.3	9793

Heavy equipment is usually required for transporting and positioning boulders. If access to the project site is unsuitable for a dump truck, cost per boulder will increase because of the additional time necessary for a front end loader or bulldozer to deliver individual boulders. Under some circumstances it may be most cost effective to transport and place boulders by helicopter.

At remote sites, boulders may be moved a short distance with hand tools such as a griphoist. An effective method for preparing to move a boulder is to drill a hole in the boulder and secure a short section of cable to the boulder using polyester resin adhesive (Figure VII-3). The griphoist cable is secured to the cable in the boulder with cable clamps. In some cases, chokers or rock nets are also used to move boulders. Griphoists must be secured to an anchor that is either found or created and should be in-line with the boulder and the final desired location. If anchoring to a live tree, measures must be taken to protect the tree. An anchor can be made by drilling a hole in bedrock or in a large boulder and securing a section of cable with polyester resin adhesive.

An effective technique is for one person to operate the griphoist while a second person works behind the boulder with a pinch bar to help guide the boulder and to prevent binding. Snatch blocks can be used to increase the pulling capacity of the griphoist, or to change the angle of pull. A griphoist is equally effective in moving large logs.

Miscellaneous Structural Materials

Geotextile fabric and woven-wire fencing material are often used together on log bank stabilization structures before back-filling with cobble and boulders. The material serves to retain bedload or fill material and help establish and maintain the integrity of the habitat structure.

CALIFORNIA SALMONID STREAM HABITAT RESTORATION MANUAL

Geotextile Fabric

Geotextile fabric is available in a variety of textural weaves, strengths, and pore sizes. It is not easily punctured or torn and is available in UV-resistant form for applications where it may be exposed to sunlight. Regardless of pore size, it appears that accumulations of fine sediment and sand eventually prevent movement of water through it. It can also be used effectively as a silt trap during construction of instream structures.

Wire Fencing

High quality wire fencing is woven rather than welded and must be galvanized to ensure longevity. Some types of fencing are PVC-coated and generally have excellent longevity, especially if covered with rock.

Geotextile fabric and wire fencing are often used together on log bank stabilization structures. The geotextile fabric prevents the fine sediment from flowing under the logs and the wire fencing adds structural stability. When using wire fence to add structural stability to a log bank stabilization structure, care must be taken to ensure the wire is properly anchored down and back-filled.

It was once common practice to install geotextile fabric and wire fencing on the upstream side of log channel-spanning structures to prevent water from flowing under the log. This practice has been discontinued. Often, the fabric and wire are lifted over the log structure by the hydraulic force of the water. This can result in the wire posing a potential hazard to people and fish.

Concrete

Concrete is a building material made by mixing cement, sand and gravel with water. Concrete is used to build walls and floors in projects such as fishways and culverts. Concrete cures under water. However, care must be taken to prevent concrete from leaking into the stream, since it is toxic to fish (pH shock) until set and cured. Broken concrete has been used in some areas as riprap. This is not recommended, since its density and resistance to scour are less than that of most rock and it usually does not stay in place or last long.

Wire Rope

Wire rope or cable comes in a variety of diameters and types. Stainless steel cable has the longest life, but is very expensive. Galvanized wire rope is coated with zinc to improve rust resistance. It is relatively free of grease coating, making it suitable for polyester resin adhesive applications. Its longevity is probably greater than non-galvanized steel wire rope. Non-galvanized steel wire rope is lubricated to alleviate abrasion between wire strands when the cable is in motion and under stress. The grease also helps to retard rusting.

CALIFORNIA SALMONID STREAM HABITAT RESTORATION MANUAL

There are several ways to cut wire rope in the field. Guillotine type cable cutters are commonly used. These work well but tend to fray the end of the cable making it difficult to push the end of the cable into a hole drilled in a boulder or bedrock using polyester resin adhesive. A skill saw equipped with a metal cutting blade makes a clean cut of the cable, leaving no frayed ends.

ANCHORING TECHNIQUES

The failure of an anchor is probable unless the structure is properly constructed following these recommended techniques. Steel rebar, wire rope, and expansion bolts are the most commonly used materials for anchoring systems. All have several varied applications. Trenching and the use of a deadman are techniques used to stabilize and hold structures in place.

Cabling to Boulders or Bedrock Using Polyester Resin Adhesive

When dealing with durable, un-fractured boulders or bedrock, the cable and polyester resin adhesive technique is a cost effective method of anchoring stream enhancement structures (Figure VII-3). The technique can be used to secure boulders in sequence, or to secure logs or root wads to boulders or bedrock. This anchoring technique can be accomplished using rock drills capable of drilling holes up to one inch in diameter, at a variety of angles.

Before using polyester resin adhesives, read and follow all manufacturer's labels concerning use of this product. Polyester resin adhesives can be used in wet or dry conditions. The hole diameter drilled must be no more than one-eighth inch larger than the cable to be used and should be approximately 10 inches deep. Clean the hole using water or air and a brush to remove all debris. All the rock dust must be removed from the hole or the polyester resin adhesive will adhere to the dust and not to the rock. Use clear, clean water to thoroughly clean drilled holes and ensure the polyester resin adhesive will adhere to the rock, not the dust or silt. Cut the cable to the proper length, keeping cable slack to a minimum between the fastening points. Clean the cable using acetone or muriatic acid. Galvanized wire rope is relatively free of grease and requires much less cleaning than lubricated wire rope. The cable must be absolutely free of oil to get a good bond with the polyester resin adhesive. It is important when using acetone or muriatic acid that precautions are taken to protect the person doing the cleaning, and that it is accomplished away from the stream in case of an accidental spill. Fill the hole approximately two-thirds full with polyester resin adhesive. Insert the cable, turning slowly when possible, until the cable hits the bottom of the hole. Air pockets left at the bottom of the hole reduces bonding strength. Polyester resin adhesive must be used prior to the indicated expiration date.

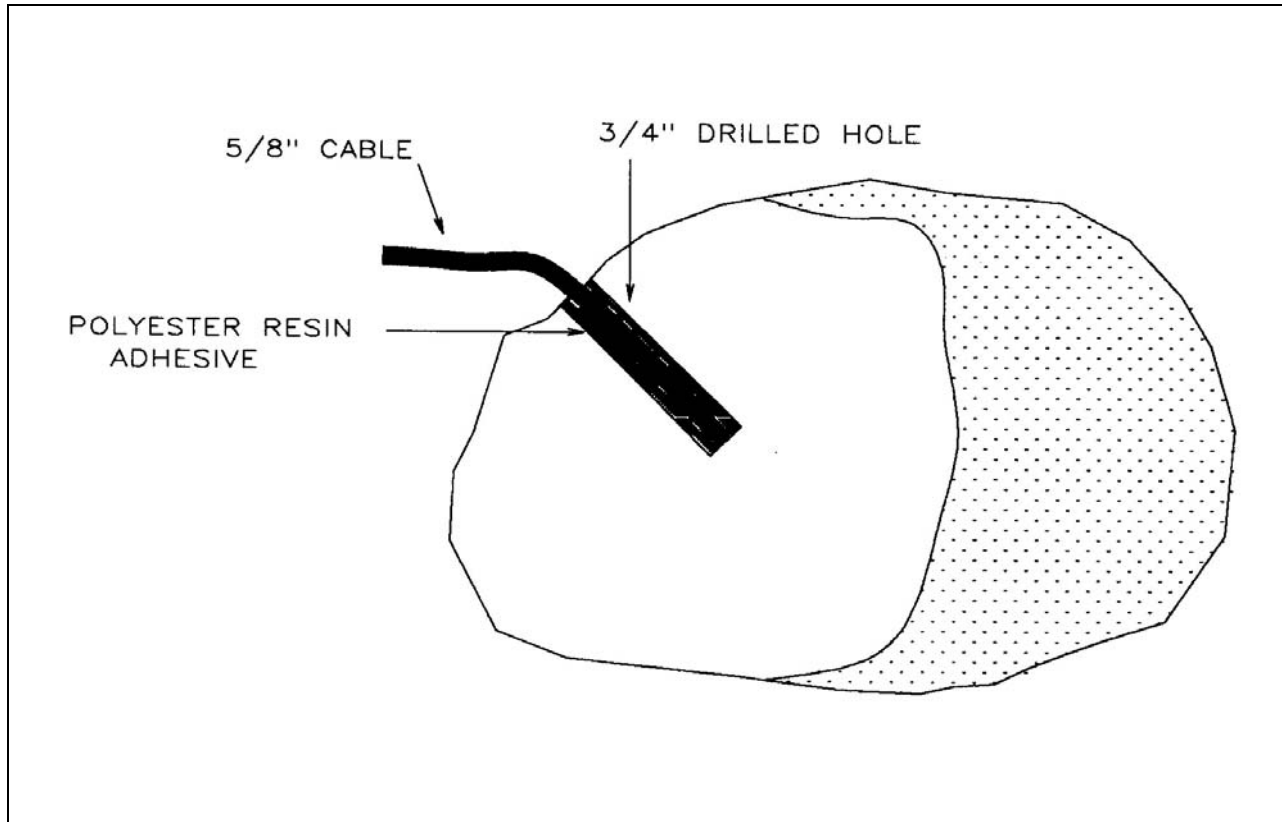

Figure VII-3. Cable secured to boulder using polyester resin adhesive.

Cabling to Logs and Root Wads

Woody material should be secured by inserting the cable through the log or root wad. Where this is not possible, notching the material to recess the cable is necessary. Always remove bark at the point of contact between the cable and the log or root wad because bark will rot, resulting in slack in the anchoring cable. When threading cable through augured holes, or wrapping it around logs or root wads, cable clamps should be used to fasten the cable. A minimum of two clamps is required to prevent slippage. The cable should be looped through the hole, and around the material and clamped back to itself. Simply placing a clamp on the end of the cable will not suffice because it can be pulled off, or pulled through (Figure VII-4).

CALIFORNIA SALMONID STREAM HABITAT RESTORATION MANUAL

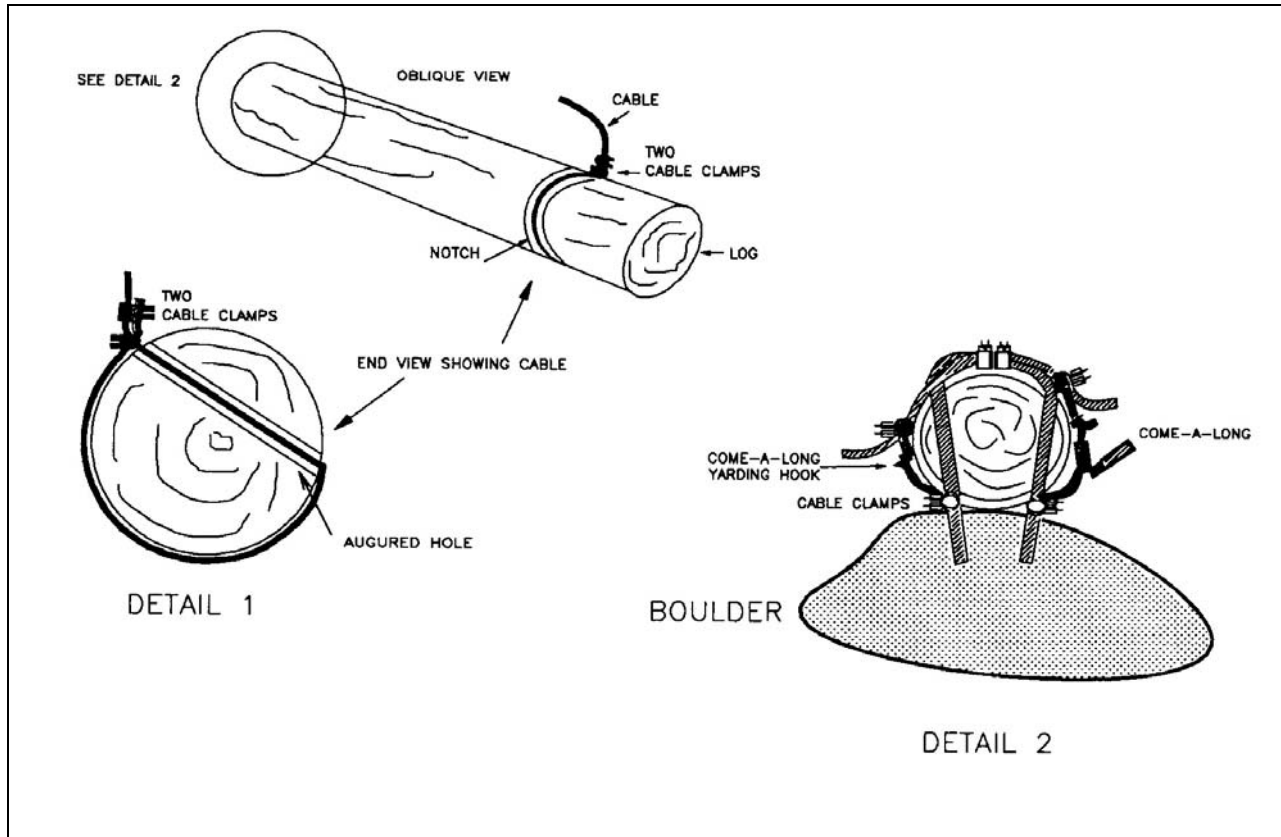

Figure VII-4. Cabling to log.

Cabling Logs and/or Root Wads to Boulders or Bedrock

Logs or root wads to be secured instream must be anchored tightly so they do not float or move. A procedure has been developed called the "two-cable method" for anchoring logs to boulders or bedrock. Two griphoists are used to pull the cables tight using this method. Commercially available cable grips, or a special tool called a cable-hook clamp can be used to facilitate tightening of cables with a griphoist.

To construct a cable-hook clamp, saw off the eye of a slip hook and weld it to a cable clamp base. Use a cable clamp one size smaller than the cable to be used (example 1/2-inch cable clamp for 5/8-inch cable). It may also be necessary to use welding rod to build up mounds in the cable cradle to aid in holding the cable ends (Figure VII-5).

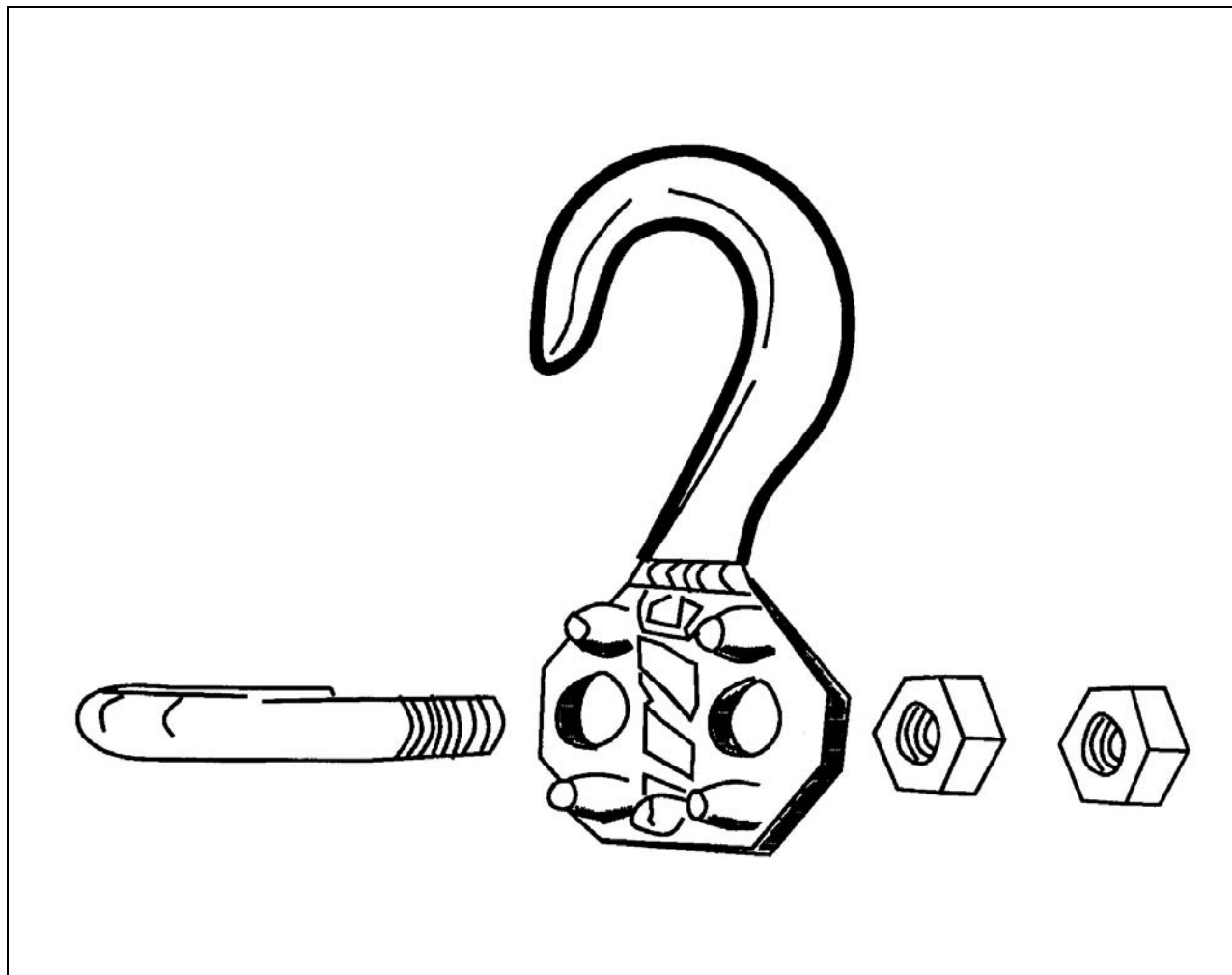

Figure VII-5. Cable hook clamp.

To cable a log to a boulder or bedrock using the two-cable method, drill two holes to a minimum depth of 10 inches. The angle of the holes should match the direction the cable will be pulled to prevent excessive bending at the rock face. The layout of the griphoist anchors must be arranged to set up opposing pulls in alignment with the log structure to be secured. Follow directions for use of the cable and polyester resin adhesive. Allow the adhesive to set up overnight. Drill holes for the cable through the log. Using the hook clamps, attach cable ends to the griphoist (Figure VII-6). Loosely attach a minimum of two cable clamps to the cables before tightening the cables with the griphoist. Pull both cable ends with the griphoist, avoiding binding as the cables move past each other. When cables are at maximum tension, tighten the cable clamps. Remove griphoists. Check cable tension. If cables are not tight, loosen the cable clamps and repeat the process. Secure the loose cable ends to the log with staples (Figure VII-7). Two variations of the two-cable method are shown in (Figures VII-8 and VII-9).

**CALIFORNIA SALMONID STREAM
HABITAT RESTORATION MANUAL**

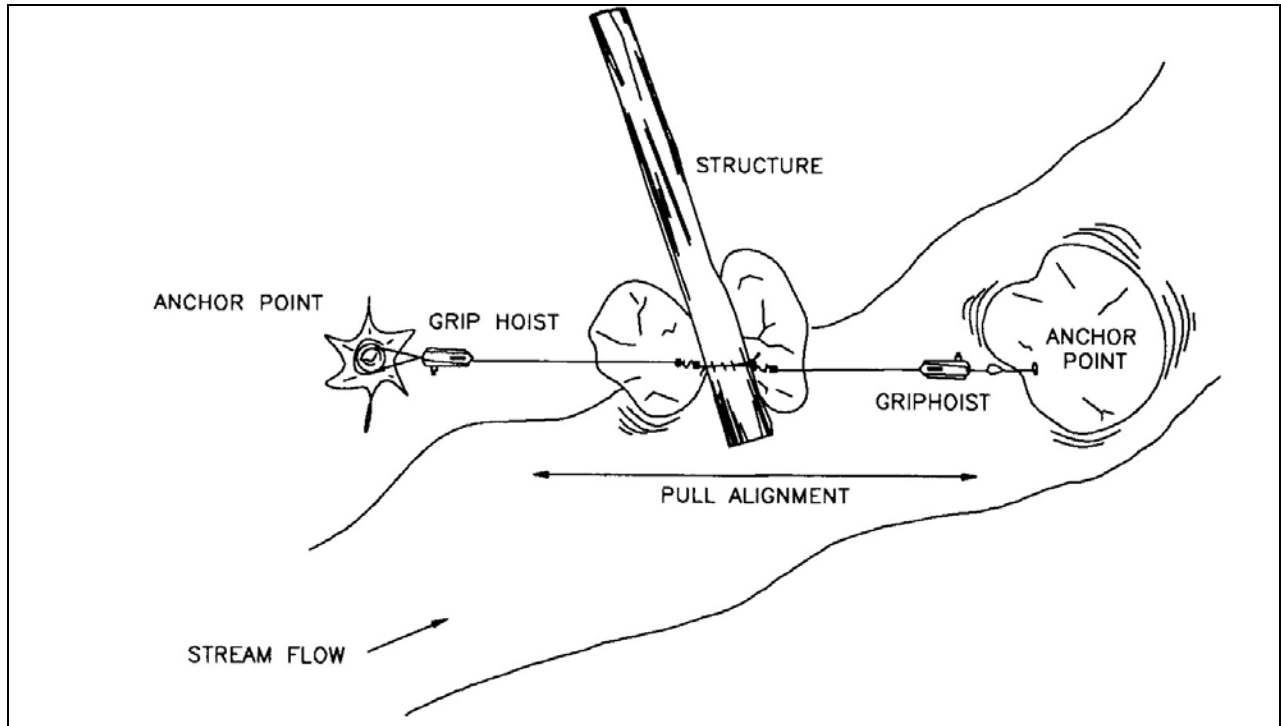

Figure VII-6. Tightening cable ends using two griphoists.

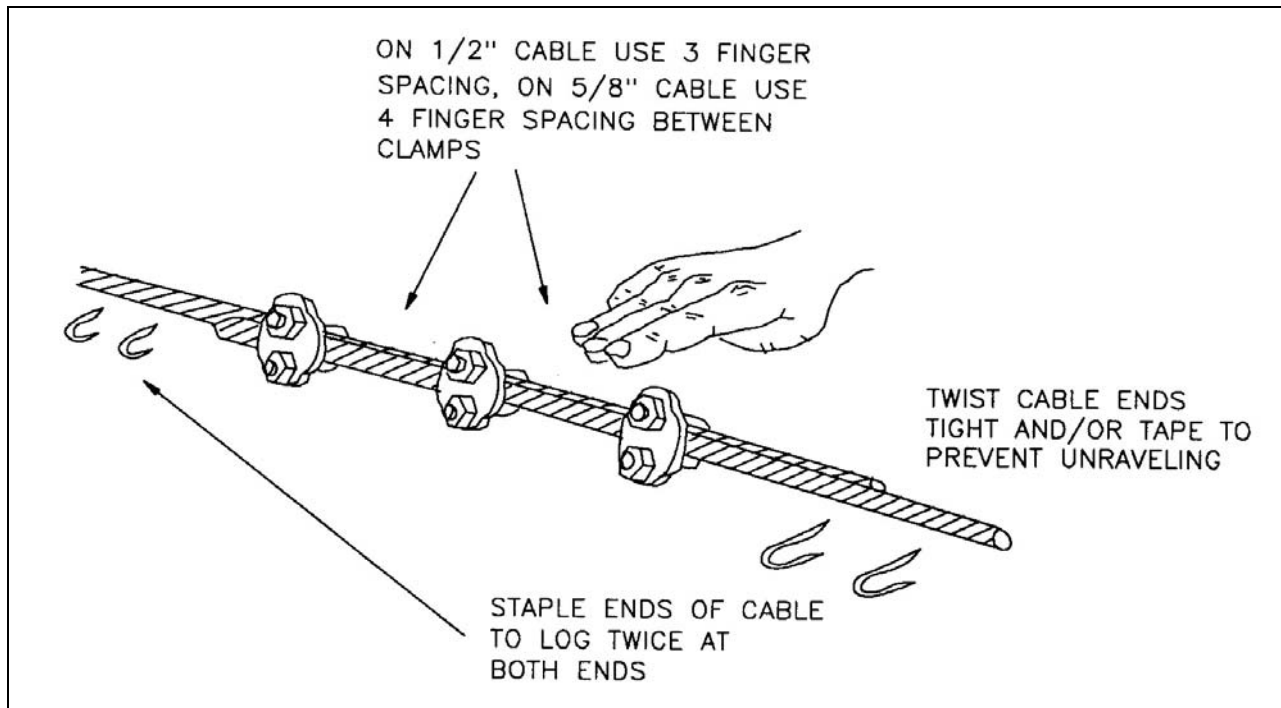

Figure VII-7. Attach cable clamps to cables.

**CALIFORNIA SALMONID STREAM
HABITAT RESTORATION MANUAL**

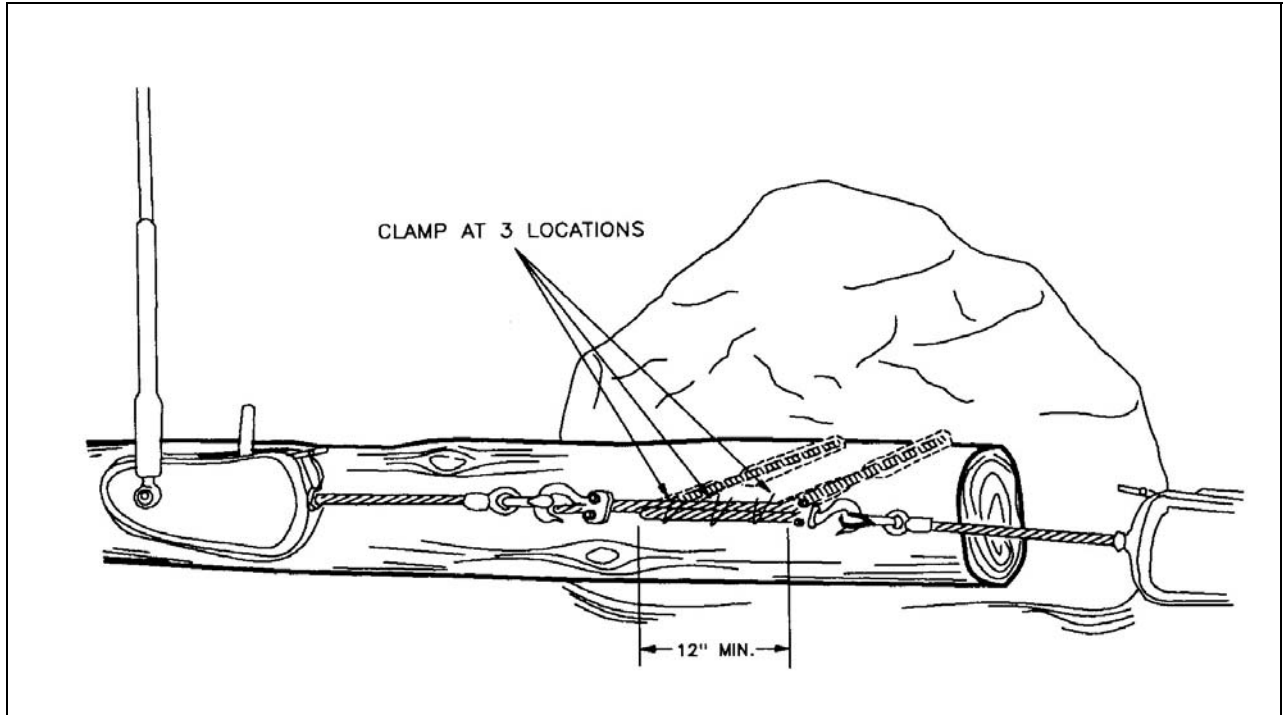

Figure VII-8. A variation of the two-cable method.

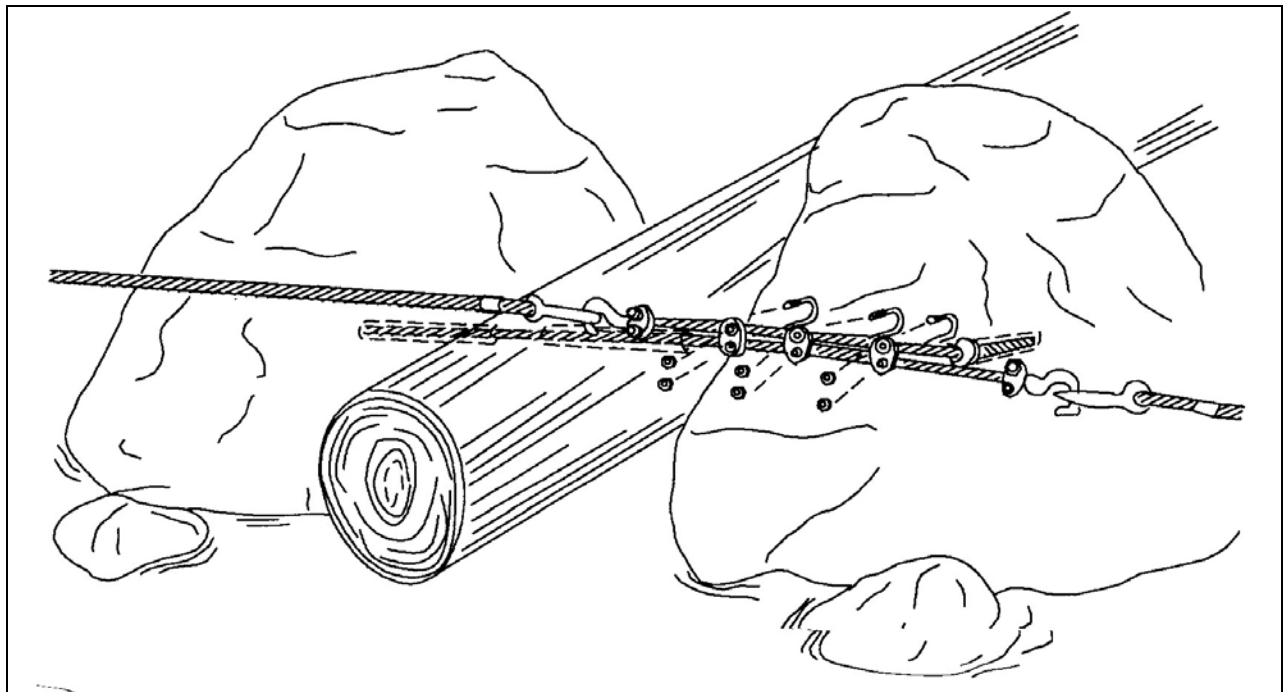

Figure VII-9. A variation of the two-cable method.

CALIFORNIA SALMONID STREAM HABITAT RESTORATION MANUAL

Log Pinning With Rebar

In addition to being a component of reinforced concrete, rebar can also be used in anchoring applications. To pin logs together with threaded rebar, an aligned hole is augered through both logs. A length of threaded rebar is inserted through the holes, a steel-plate washer and nut are then placed on both ends of the rebar and tightened to secure the logs. Before driving in threaded rebar, a nut must be threaded on the impact end of the rebar to protect the threads from being damaged (Figure VII-10). After the nut has been tightened, the end of the threaded rebar must be mushroomed to prevent the nuts from backing off. Minimum recommended size of threaded rebar is one-inch. The minimum size steel-plate washer recommended is three-inches square, by one-quarter inch thick.

If standard non-threaded rebar is used, a pilot hole slightly smaller than the diameter of the rebar should be drilled through the log(s). The rebar is then driven in far as possible using a metal fence post driver, then a sledge hammer is used to drive it the rest of the way. It is important to bend over the ends on the rebar at least at a right angle so logs will not lift off.

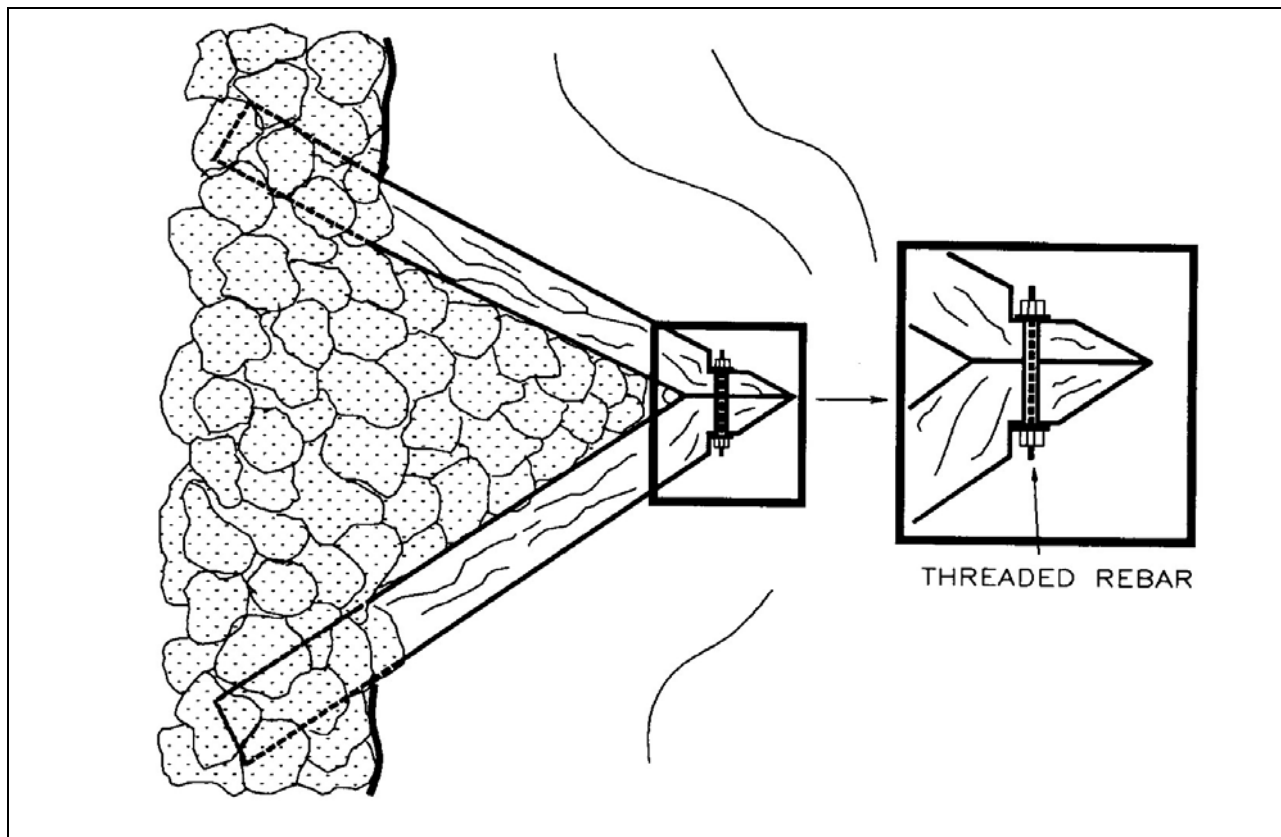

Figure VII-10. Threaded rebar used to secure two logs together.

CALIFORNIA SALMONID STREAM HABITAT RESTORATION MANUAL

Stream Bank Anchors Using Rebar

Steel rebar can be driven into the stream bank to hold log structures in place. This technique is only to be used in conjunction with additional anchoring techniques such as a deadman, cable secured with polyester resin adhesive to a boulder or bedrock, or with threaded rebar to a stable or embedded log (Figure VII-11). Logs are very buoyant and will float away if not securely anchored.

A post driver or sledge hammer are best suited to driving rebar. Rebar anchors must be at least 10 feet in length, to ensure that they are not uncovered by high stream flows. The rebar can be trimmed to create a point. The pointed end will help penetrate hard ground or buried woody debris. If scour is expected at the end of a structure, the ends should be anchored by other means.

Often, rebar cannot be driven into a heavily armored stream bank. It frequently bends at cobble and boulder obstructions, or reaches impenetrable bedrock. However, an increased number of rebar anchors may be able to compensate for shallow penetration.

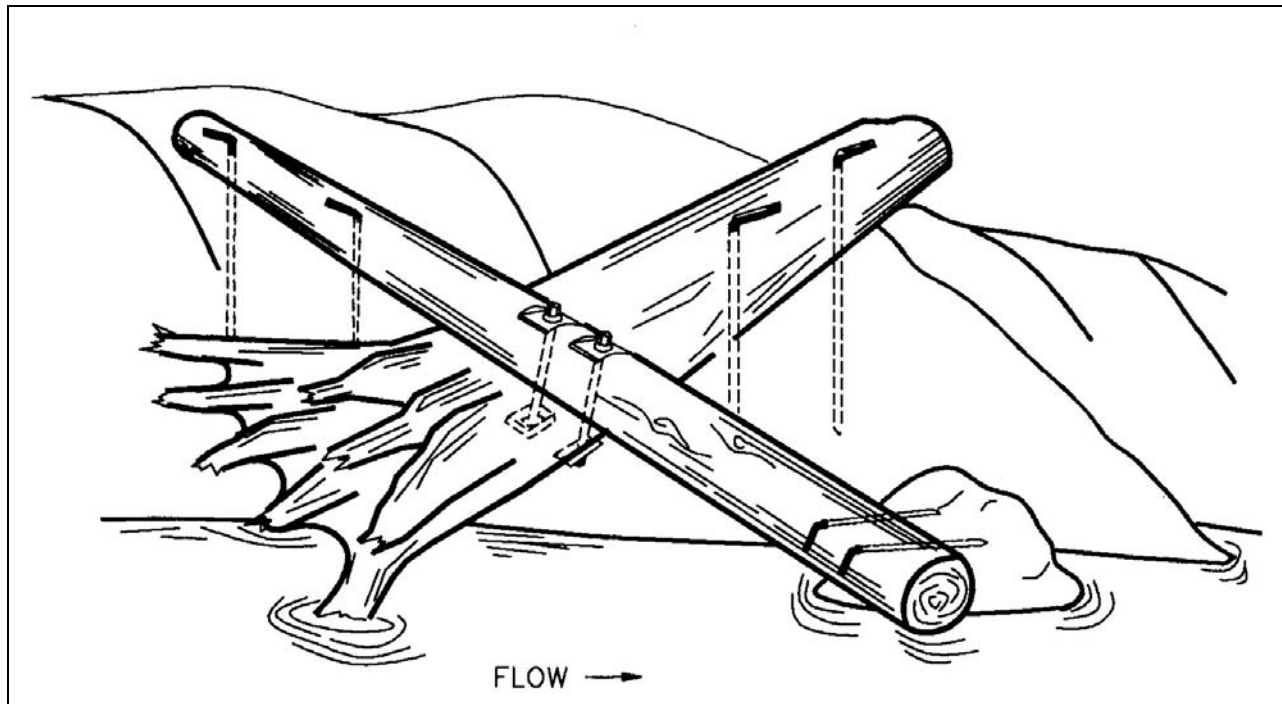

Figure VII-11. Rebar anchoring application.

CALIFORNIA SALMONID STREAM HABITAT RESTORATION MANUAL

Bedrock and Boulder Anchors Using Threaded Rebar

Threaded rebar can be secured to bedrock using polyester resin adhesive (Figure VII-12). Hole depth must be sufficient to reach competent, un-fractured rock in order to obtain maximum bonding strength. A minimum of 10 inches is recommended. Setting rebar into fractured rock or into a hole that has not been cleansed of rock dust may not produce a reliable bond.

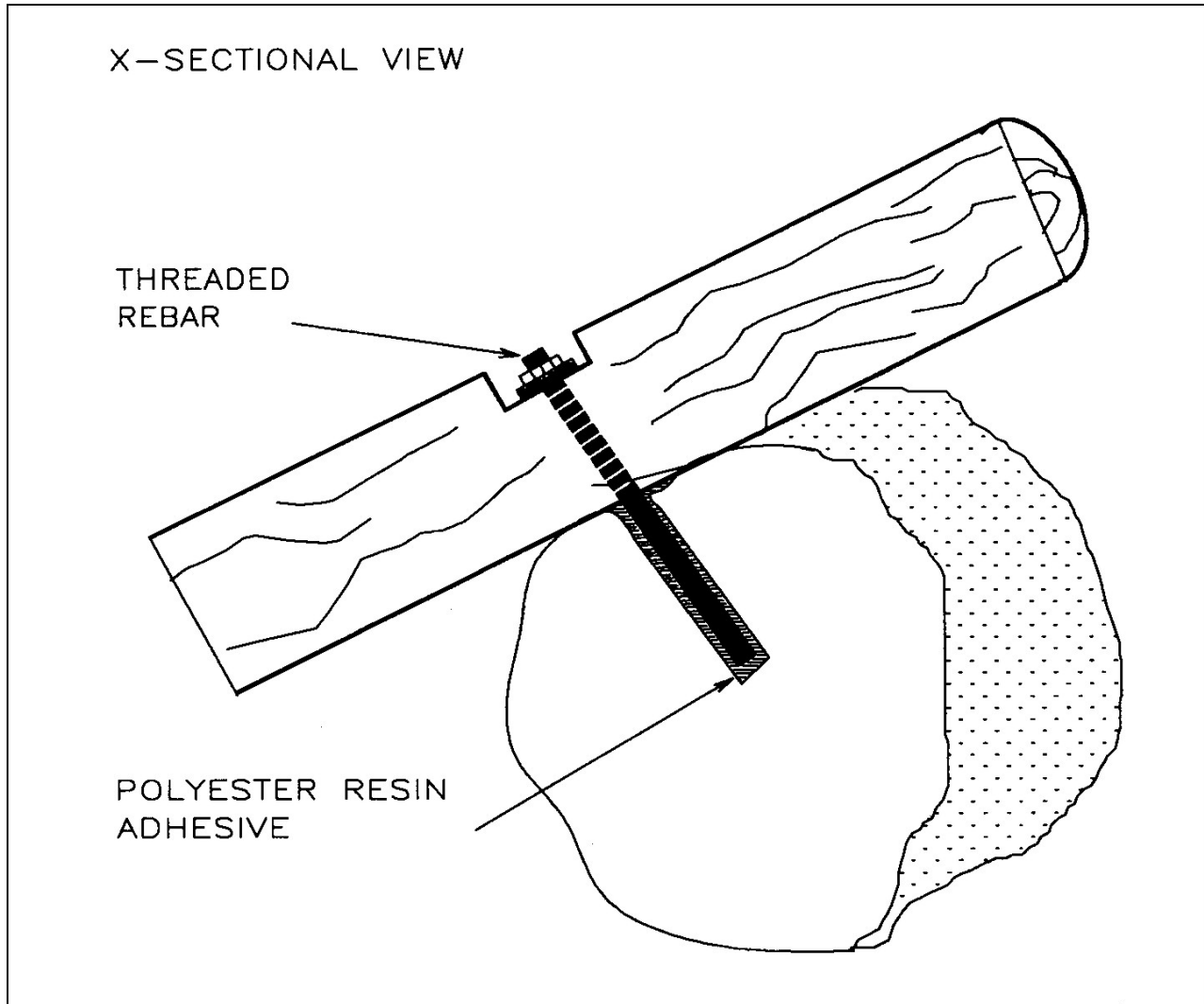

Figure VII-12. Threaded rebar anchoring log to boulder, using polyester resin adhesive.

CALIFORNIA SALMONID STREAM HABITAT RESTORATION MANUAL

Threaded Rebar and Cable Anchor to Boulder or Bedrock

North Coast Fisheries has developed an anchoring technique using threaded rebar, cable and polyester resin adhesive to secure logs or root wads to boulder or bedrock. The log is moved into position. Holes are drilled into the boulder or bedrock after the log is in-place. The cable is secured to the bedrock or boulder using polyester resin adhesive. The adhesive is allowed to cure overnight. A hole is drilled through the log in line with the cables. The bark and cambium layer of the log are removed so the plate will fit against the heartwood of the log. Threaded rebar is driven through the hole leaving three to four inches of rebar sticking out on each side. A loop is formed on the end of the cable using two cable clamps. The loop is tightly threaded over the rebar leaving as little slack as possible. The cable clamps used to form the loop in the cable are tightened down. The metal plate and nut are threaded on the rebar and tightened down (Figure VII-13).

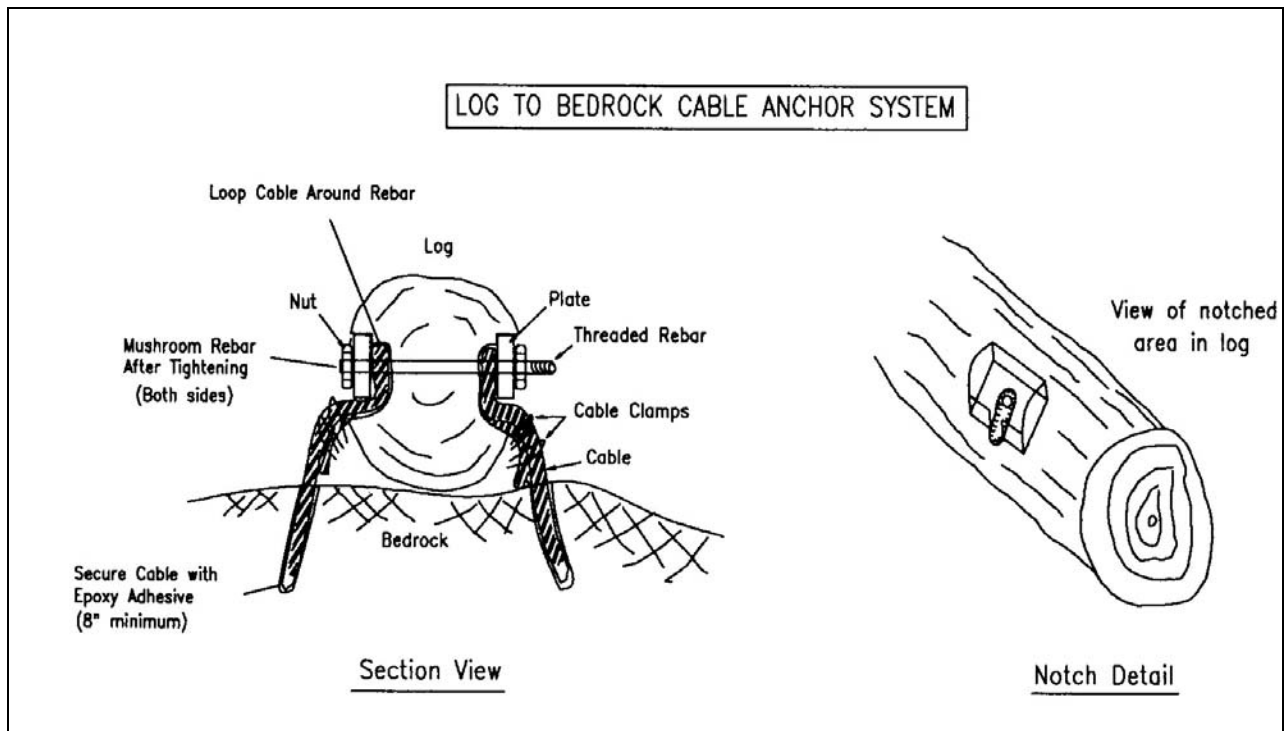

Figure VII-13. Threaded rebar and cable anchor to boulder or bedrock.

CALIFORNIA SALMONID STREAM HABITAT RESTORATION MANUAL

Expansion Bolts

Steel expansion bolts provide a means for establishing an anchor point in concrete. This method is commonly used when anchoring steel Washington baffles in concrete box culverts. There are a wide variety of commercially available anchors suitable for fish habitat construction purposes. Typically, a series of ridges on drop-in anchors are embedded in the sides of a drilled hole as the anchor is expanded by insertion of a threaded bolt; or a clip is expanded and wedged into the sides of a hole when a nut is tightened to compress it against the opposite end of the bolt (Figure VII-14).

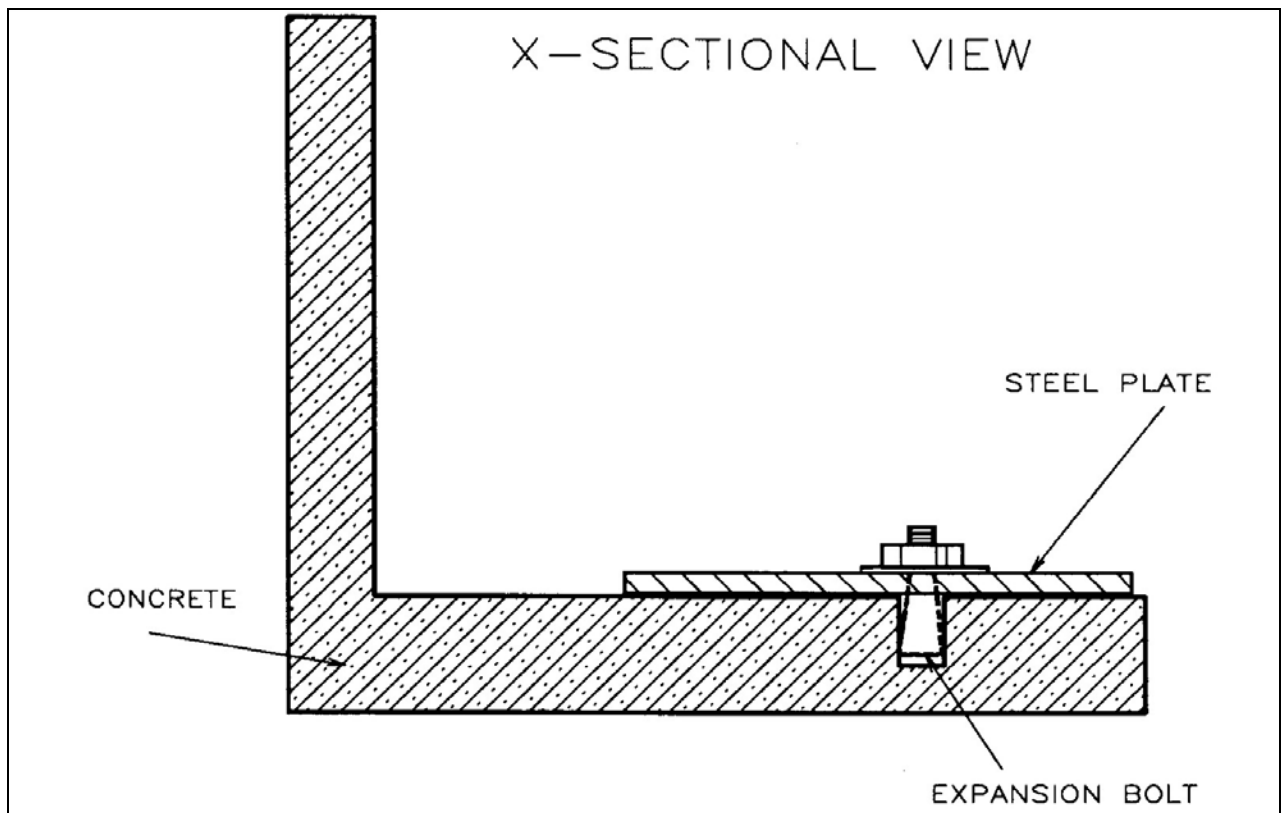

Figure VII-14. Expansion bolt into concrete.

CALIFORNIA SALMONID STREAM HABITAT RESTORATION MANUAL

Trenching

Trenching is an anchoring technique that is used to "key-in" or recess structures. Recessing a log or boulder into trenches excavated in the substrate or the bank reduces the chances of high stream flows undermining the structure or cutting around the structure's ends. Trenching stream banks to key in structures can only be accomplished where suitable, stable banks are present. Trenching can be performed either with heavy equipment or by hand (Figure VII-15).

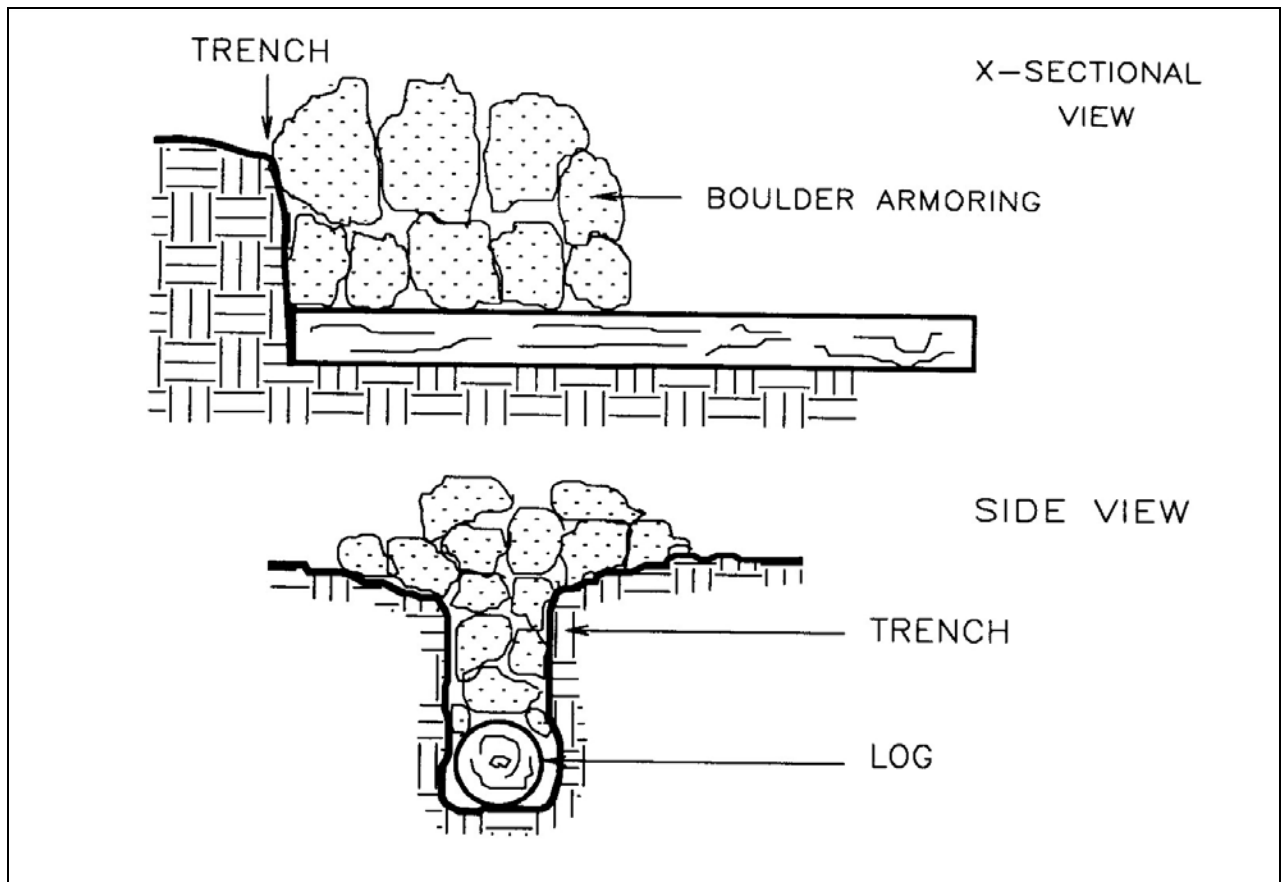

Figure VII-15. Trenching.

CALIFORNIA SALMONID STREAM HABITAT RESTORATION MANUAL

Deadman

Where no natural anchors, such as trees, stumps, or boulders are present, an anchor point must be constructed. This is possible using a "deadman". A log, boulder, gabion, or other structurally sound object can serve as a deadman. The deadman is buried in the stream bank, and becomes a stable substrate fixture.

The deadman must be buried at least 3-feet deep on the stream bank above bankfull flow. The deadman, with several attached anchoring cables, is placed in the pit. The cables extending from the deadman are placed in narrow trenches dug down to the instream structure. After attaching the cables to the habitat structure, the cables are tightened, and the pit and trenches are back-filled and compacted (Figure VII-16).

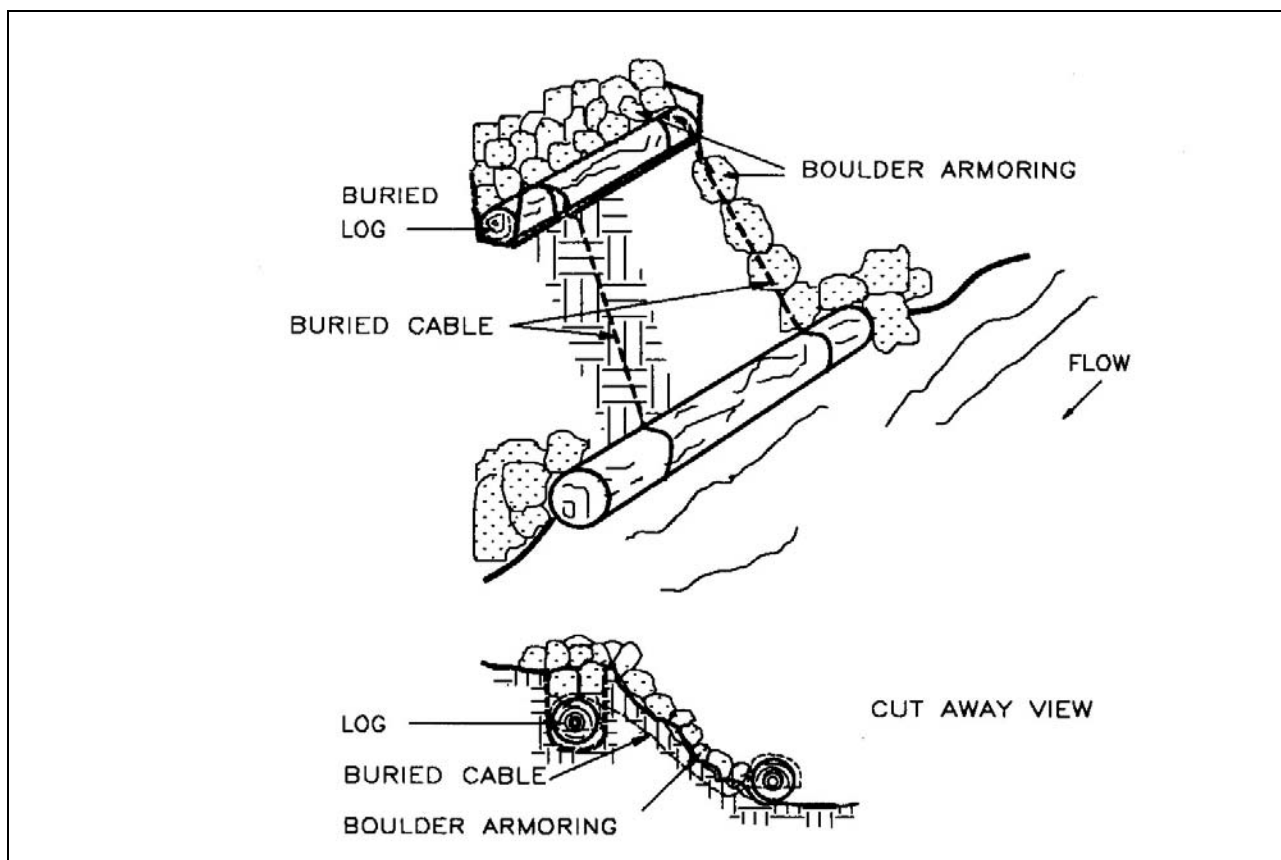

Figure VII-16. Deadman.

CALIFORNIA SALMONID STREAM HABITAT RESTORATION MANUAL

Unanchored Large Woody Debris

Most instream habitat enhancement structures require some type of anchoring technique to ensure they will remain in place during high flow events and to prevent high flows from altering their configuration and intended function. However, in particular cases the addition of unanchored large woody material may be beneficially used to enhance some streams and stream reaches. In small streams, large woody debris (LWD) is often the structural agent in pool formation or a key element associated with the habitat quality of a pool. The effect LWD has on channel morphology is influenced by its size, orientation, spacing, and association with other structural elements as well as a number of other variables including stream-flow energy, sinuosity, substrate, bank composition, and channel width. First through third order streams are generally best suited for unanchored LWD placement projects. Where appropriate, the placement of unanchored LWD requires no maintenance and are free to adjust naturally to the stream's hydraulic regime.

In unanchored applications, logs selected for placement should have a minimum diameter of twelve inches and a minimum length 1.5 times the mean bankfull width of the stream channel type reach and the deployment site. A root wad should be selected with care and have a minimum root bole diameter of five feet and a minimum length of fifteen feet and at least half the channel type bankfull width. Regardless, a DFG Fish Habitat Specialist must be consulted prior to initiating these projects and obtaining necessary DFG permits.

CALIFORNIA SALMONID STREAM HABITAT RESTORATION MANUAL

INSTREAM HABITAT IMPROVEMENTS

There are three general categories of the most commonly used instream structures: 1) cover structures; 2) boulder structures; and 3) log structures. Often a single structure or combination of structures will provide for rearing, spawning, and cover. It is important that instream structures be monitored after high flows have occurred to determine if the desired habitat condition has been met (Part VIII, Project Monitoring and Evaluation). Often, maintenance or modification is needed to make the structure perform properly.

Cover Structures

Quality of a pool can be increased by adding cover structures. Amount of effective cover and the complexity of habitat is at least as important as the physical amount of pool created. Strategically placed cover can help keep pools scoured, while improperly placed cover will cause deposition of sediment.

A study on the effectiveness of placing tree bundles of fir, alder, maple, and myrtlewood was conducted on five different Oregon streams. Juvenile coho and steelhead populations were sampled in 16 pools before and after tree bundles were added. Before the tree bundles were added the pools sampled were holding 12 percent of their summer coho population during the winter. The following year, after tree bundles were added, these same pools contained 74 percent of their summer coho population during the winter sampling. The sampling showed an increase in steelhead populations between the summer and winter populations, the winter after tree bundles were added.

Riparian vegetation is a highly important source of cover. Overhanging vegetation or undercut banks, along with the associated roots, provide excellent, effective cover.

Logs, root wads, tree bundles, and boulders are the primary cover elements added to pools. Some guidelines concerning construction and installation of cover structures in a stream are:

- Cover should be incorporated with other stream enhancement structures such as log and boulder weirs, boulder clusters, and single and opposing wing-deflectors.
- Cover structures are often placed in pools, backwater areas, or along meanders to provide protection.
- Logs, tree bundles, or root wads can be cabled against the banks. Secure logs or root wads to a stump, a live tree, a bedrock outcropping, large boulders, or use a deadman. Cover can also be cabled to instream boulders using polyester resin adhesive.
- Cable all log and root wad cover structures tightly.
- Protect the upstream end of logs from direct flow of the stream.

CALIFORNIA SALMONID STREAM HABITAT RESTORATION MANUAL

Examples of cover structures are divide logs; digger logs; spider logs; and log, root wad and boulder combinations.

Divide Logs

Divide logs are installed mid-channel in spawning riffles to provide a visual barrier between adjacent spawning areas. This can increase spawner use of a riffle area and provide escape cover (Figure VII-17).

Divide logs require suitable substrate for anchoring. Such substrate consists of boulders or bedrock. Length and diameter of the log used will be dictated by length of the spawning channel and depth of flow. In general, divide logs should be 18 to 36 inches in diameter.

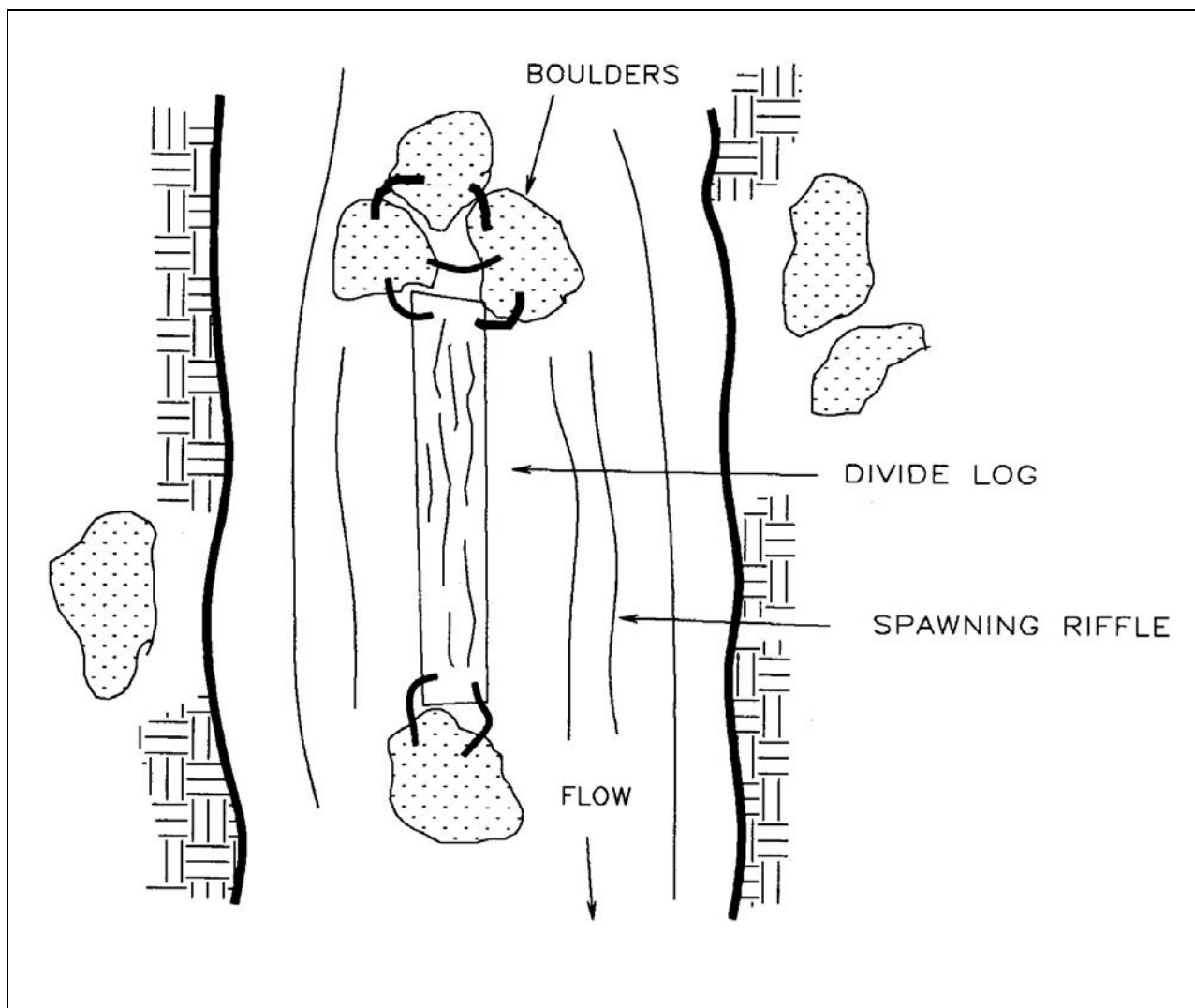

Figure VII-17. Divide log.

CALIFORNIA SALMONID STREAM HABITAT RESTORATION MANUAL

Digger Logs

Digger logs are placed with one end anchored securely on the bank and the other end plunging into the bottom of a pool. Primary use of digger logs is to enhance pool habitat by creating diverse cover for rearing juveniles as well as for migrating adults. They are also used to scour the channel, creating or expanding pool habitat. Logs with root wads intact should have the root wad end extending down into the pool to offer the most complexity for increasing rearing habitat and maximizing scour (Figure VII-18). Digger logs will be most secure when two-thirds of the log is on the bank and one-third of the log extends into the channel.

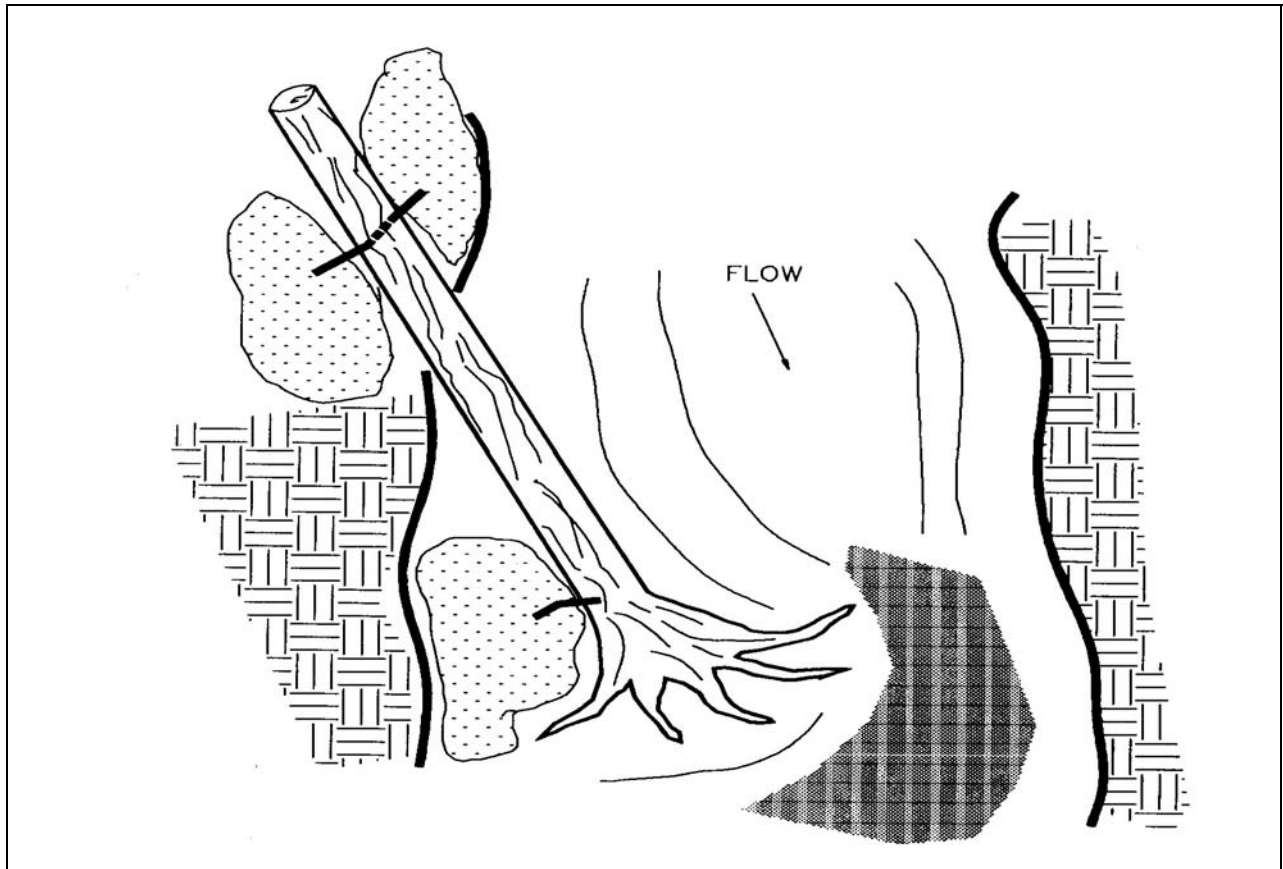

Figure VII-18. Digger log.

Digger logs are usually secured to bedrock and held in place using cable and polyester resin adhesive, or secured to live trees or downed wood with threaded rebar. The log must be anchored in at least two places, with anchors spaced as far apart on the log as possible to keep it secure during high flows. Digger logs can be set in a trench dug into the stream bank. At least one-third of the length of the log should be placed in the bank. This buried end of the log should be covered with boulders to anchor the structure. If the digger log is to successfully create scour, it is important that the end of the log in the water does not float during high flows. Digger logs will usually be positioned to point downstream, although there may be some situations where pointing them upstream would be appropriate (where the intention of the log placement is to create scour). The vertical angle of the log should usually be 30 to 45 degrees to the bank.

CALIFORNIA SALMONID STREAM HABITAT RESTORATION MANUAL

Spider Logs

Spider logs, also called mini log jams, are several logs placed at angles to mimic a log or debris jam. They provide cover for juvenile rearing and adult spawning and collect woody debris to increase diversity. Their use is restricted to areas where there is no danger of causing bank failure or channel migration. Pools and backwater eddy areas on the stream channel margins are the best locations for these structures (Figure VII-19).

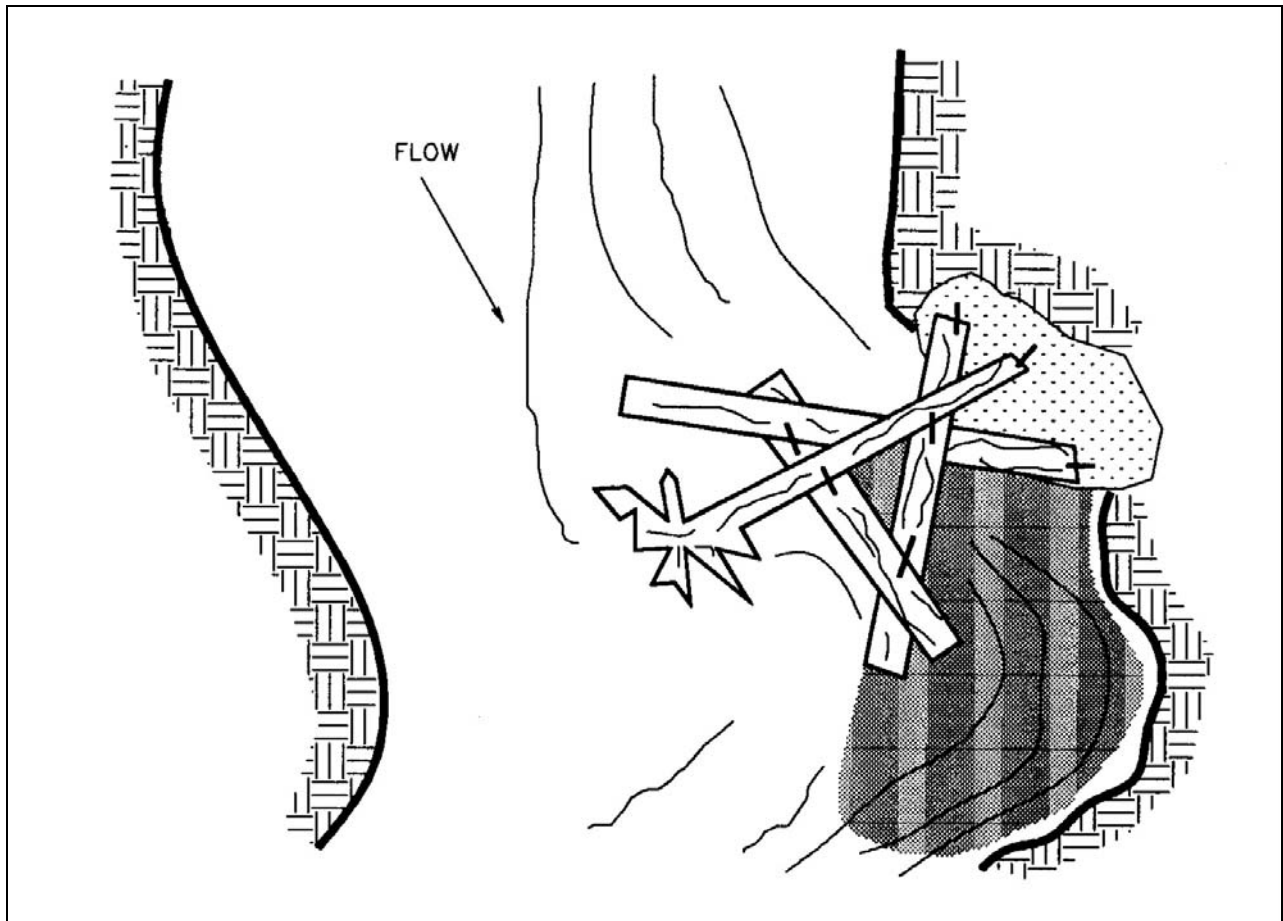

Figure VII-19. Spider logs.

CALIFORNIA SALMONID STREAM HABITAT RESTORATION MANUAL

The structures are composed of several logs placed across each other, in the shape of a triangle, to imitate a natural debris or log jam. Each of the logs must be secured to bedrock or large boulders in the channel with cable and polyester resin adhesive, or to live trees with threaded rebar. The logs are secured together with threaded rebar. Several other logs with branches and root wads attached are then fastened to these structure logs with cable or threaded rebar.

Caution must be used in locating these structures as the potential for an adverse effect is great. Before placing spider logs it is necessary to determine channel capacity and bankfull discharge that can be expected. Log structures should not reduce channel capacity below flood stage needs or a massive log jam and sediment trap could develop.

Log, Root Wad, and Boulder Combinations

Log, root wad, and boulder combinations combine the two main forms of structure added to a stream to enhance habitat. The longevity of boulders combined with the cover provided by logs can create habitat that is superior to that offered by either element individually.

Log, root wad, and boulder combinations are used to create cover for juvenile rearing. These structures also act as resting areas and escape cover for spawning salmonids. By creating velocity shear zones they create areas of deposition as well as scour, thereby enhancing spawning through gravel sorting (Figure VII-20).

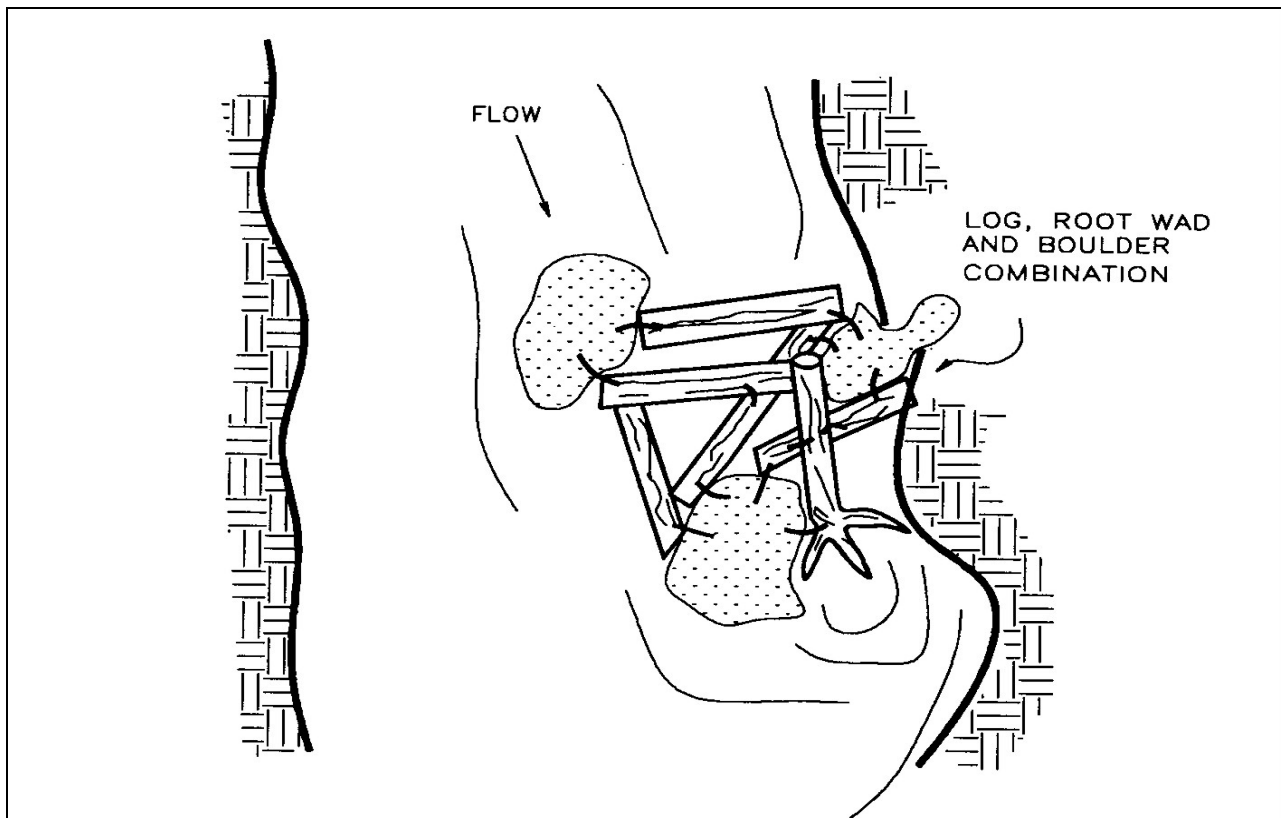

Figure VII-20. Log, root wad, and boulder combination.

CALIFORNIA SALMONID STREAM HABITAT RESTORATION MANUAL

Methods used to install log, root wads, boulder combination structures are the same as those used for installing log or boulder structures. The boulders used must be of sufficient size to counteract the buoyancy of the logs. Because of the potential for deflecting high flows into adjacent stream banks, it is important to make sure that banks are resistant to erosion or to take steps to increase their resistance by armoring them with boulders and/or logs.

Boulder Structures

Boulder structures are placed in the active channel and along stream banks for creating a desired habitat type. They are used to break up or diversify stream flow in a particular stream reach, to provide instream cover for juvenile salmonids and spawning adults, or to recruit spawning gravel. It is desirable to create a variety of stream flow velocities, because juvenile salmonids will select different velocities depending on whether they are feeding or resting. Different water velocities will also sort gravel and create diversity in the substrate.

Boulders are well suited for diversifying flows because they are resistant to being displaced by high flows. Because of this they can be placed mid-channel without constructing a full-channel spanning structure. The interstices in boulder clusters and between large boulders can provide escape cover for juvenile and adult salmonids. Boulders must be sized according to stream discharge and channel morphology. Whenever possible, it is best to individually select boulders for use in a project.

There are several disadvantages to using boulders. One is that boulders often must be hauled to the construction site from a quarry. If there is not a quarry nearby, the cost of buying and trucking boulders can be very high. A second problem with using boulders is that if they are placed in mobile substrate, perimeter scour may cause the boulder to bury itself. For this reason, it is necessary to use large boulders, or to secure boulders using polyester resin adhesive and cable to form a larger structure.

Design of boulder structures depends upon the primary function to be served. The range of flows to which a particular structure or series of structures may be subjected will dictate size of boulders to be used, and proper anchoring techniques to be employed.

Boulders can be used in a variety of situations and configurations to perform a desired function or fulfill a particular habitat need. Possible configurations of boulders include weirs, clusters, and single and opposing wing-deflectors.

Boulder Weirs

Boulder weirs are primarily used to collect and retain gravel for spawning habitat, or to create one or more jump pools to facilitate fish passage on marginally accessible or impassable stream reaches. Such fish barriers may be natural or human-induced.

CALIFORNIA SALMONID STREAM HABITAT RESTORATION MANUAL

When designing a boulder weir, the following factors must be considered. The boulders used should be larger than boulders occurring naturally in the stream. Large angular boulders are most desirable as they are least likely to roll out of place during high flows. Improper placement of downstream-V and diagonal weirs may direct flow in a manner creating undesirable erosion.

Weirs that span the full channel width can be configured in several shapes including: 1) perpendicular to the flow (if used for back-flooding); 2) diagonal; 3) downstream-oriented "V" (Figure VII-21); and 4) "U"-shaped (if used to improve spawning gravel). General construction principles are the same for all configurations; only one description of construction techniques is presented.

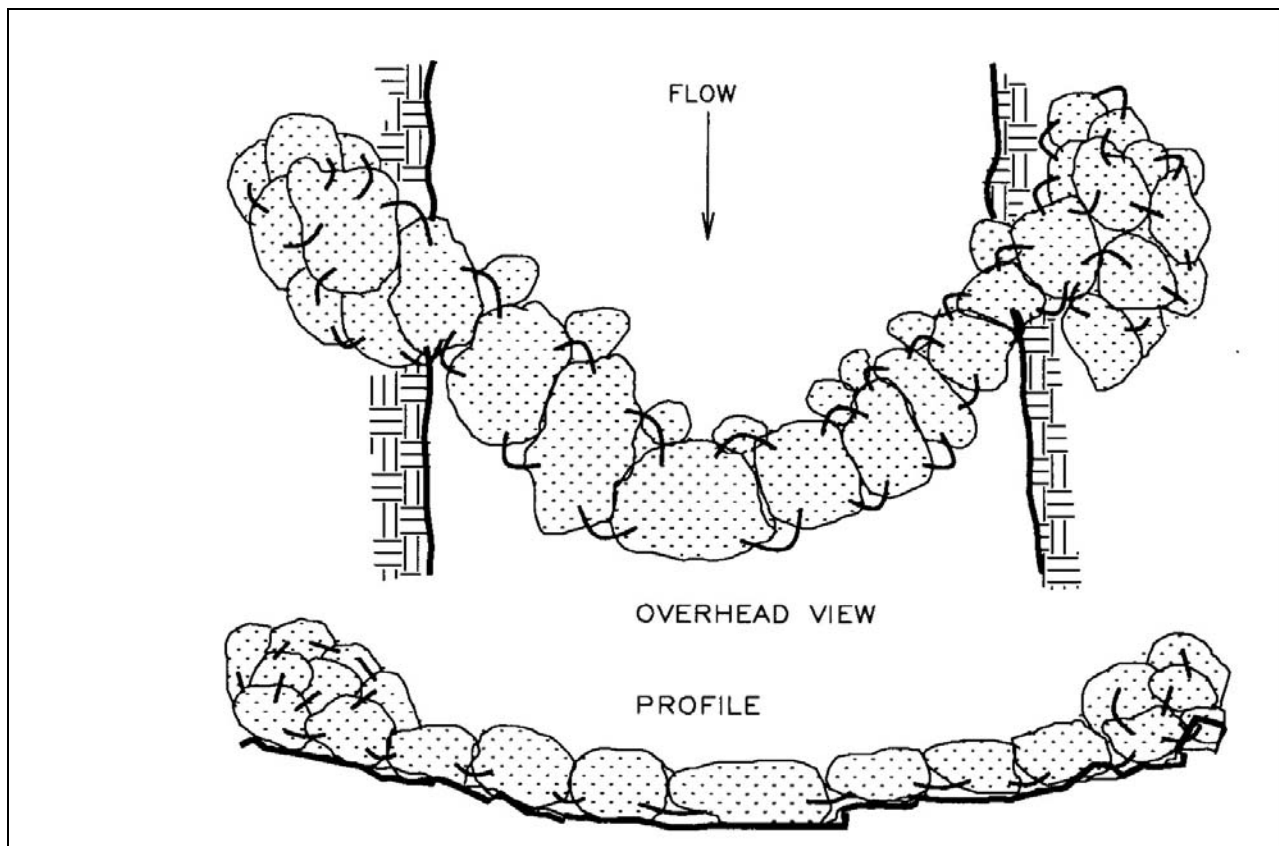

Figure VII-21. Downstream-V boulder weir.

Weirs should be keyed 4 to 6 feet horizontally into stream banks with a gradual downward slope of the weir height toward the thalweg. This slope can be adjusted to position the thalweg. The thalweg will tend to follow the low point in the weir. At the low point of the weir a "spillway" should be constructed by creating an opening one to two feet wide. This creates a notch through which flow is concentrated at low flows. The notch should be roughly triangular in shape with the apex of the triangle oriented down. Flat, broad spillways make fish passage difficult.

The weir should be sealed with smaller rock and cobble to prevent seepage flow and maintain flow over the spillway. This helps to prevent the weir from becoming a low flow barrier to juvenile salmonids.

CALIFORNIA SALMONID STREAM HABITAT RESTORATION MANUAL

To assure that the stream is not diverted around the end of the weir during high flows, ends of the weir should be extended to a point above normal high water level. Ends of the weir should be set in a trench dug to a depth of at least one boulder diameter. In bedrock substrate, the boulders on the ends of the weir should be cabled to bedrock. It is important that during high flows the stream does not flow around the end of the weir and cause bank erosion, or establish a new channel.

Quarry boulders will typically be more angular than stream boulders, and depending on the size of the boulders, will be fairly resistant to movement by stream flow. Therefore, they are usually considered to be superior to stream boulders for weir construction. Density of the boulder will also affect its stability in the stream, and how well it stands up to being drilled for cabling. Size of the boulder selected will depend on size available and the magnitude and velocity of stream flow. In general, the bigger the boulder the better. However, the boulder must suit the size of the channel (i.e., a 6-foot diameter boulder would not normally be placed in a 10-foot wide channel, or bank scour is likely).

Oversized boulders are seldom a problem. The opposite is more often the case. If boulders are relatively small and will be subjected to flows of such magnitude that they would not be stable in the stream, they should not be used. Even with suitably sized boulders it is often desirable to secure the boulders together using cable and polyester resin adhesive to create a stable structure. Cabling requires drilling holes into adjacent boulders and securing them with short lengths of cable. It is important that the cables are no longer than the distance between the boulders plus the depth of the holes. Drill the holes in the sides of the boulders (never the top). Any slack or flex in the cable will allow the boulders to move. By cabling adjacent boulders together, a series of boulders effectively creates a single unit which will remain stable during high flows.

Scour created on the downstream side of boulders may create a crater and cause boulders to roll into the scour hole. This is particularly true with stream boulders which tend to be rounded from abrasive action of years of high flows. Cabling boulders together will help reduce the tendency of the boulders to roll. Where possible, boulders should be imbedded into the substrate to a depth one third of their diameter to compensate for their tendency to roll downstream.

A boulder weir can be one or more rows wide. By setting the downstream row or rows of boulders at progressively lower elevations than the one above, a more gradual drop of stream elevation can be created so the energy in the plunge effect of the water flowing over the weir is dispersed over a wider area. Scour will occur slightly farther downstream and won't be as likely to undermine the boulders. Fish passage must be considered when designing weirs with wide crests.

If placed in a series, the appropriate distance between weirs depends on stream gradient and height of the weirs. In general, spacing should be such that water backed up by one weir will not affect the depth of the water in the plunge pool of the upstream weir. It is important to consider leaping abilities of the fish to be benefitted by the project. In general, no jump should be higher than 12 inches.

CALIFORNIA SALMONID STREAM HABITAT RESTORATION MANUAL

Vortex Boulder Weir

Vortex boulder weirs were designed by Wildland Hydrology for use in high bedload streams to maintain sediment transport capacity and low width/depth ratios (Figures VII-22, VII-23, and VII-24). These structures are most appropriate in >F= and >B= type channels. Vortex boulder weirs:

- 1) Provide instream cover and deepen feeding areas in riffle habitats;
- 2) Provide a wide range of velocities for salmonid holding water at high flow without creating backwater or sediment deposition;
- 3) Act as a grade control structure without upstream lateral migration, bank erosion or aggradation, characteristic of some log or boulder weir designs;
- 4) Maintain a low width/depth ratio to reduce sediment deposition and maintain the sediment transport capacity of the channel.

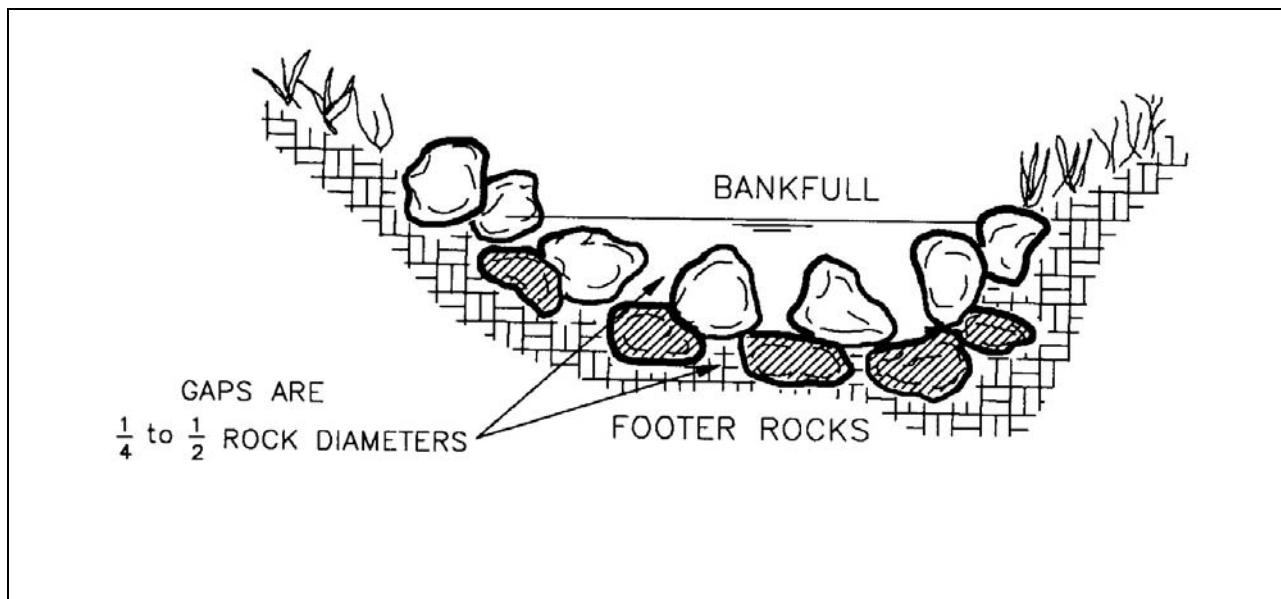

Figure VII-22. Vortex boulder weir, cross section view (Rosgen, 1993).

**CALIFORNIA SALMONID STREAM
HABITAT RESTORATION MANUAL**

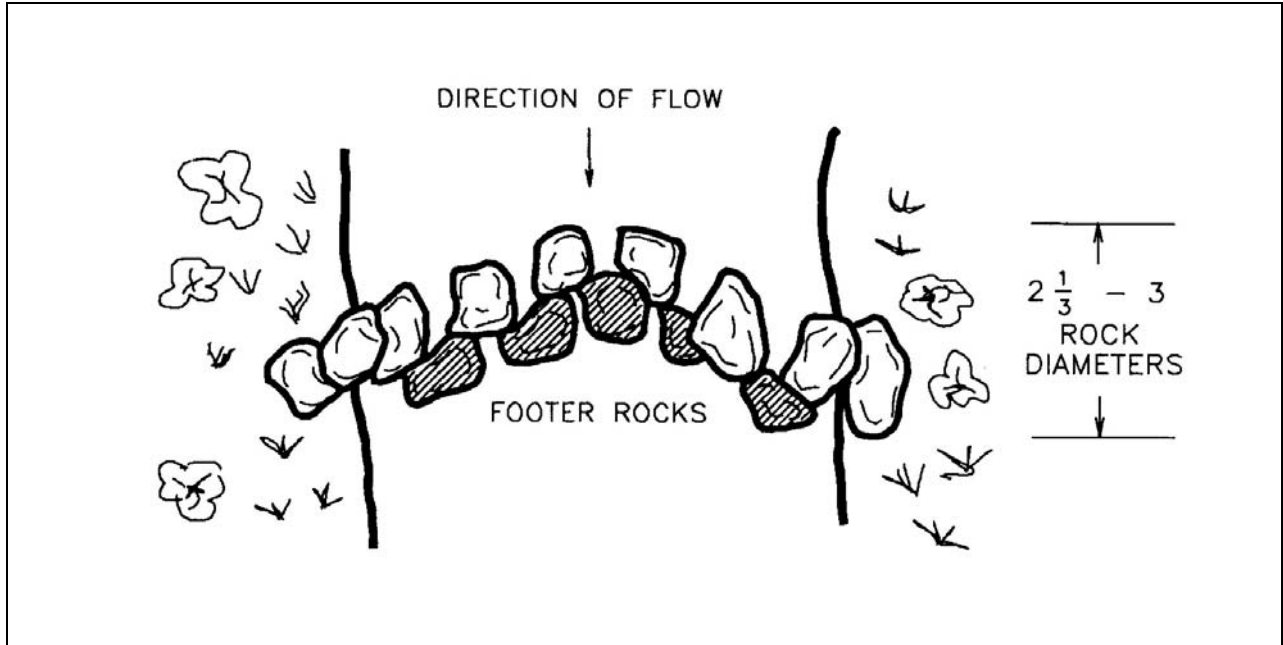

Figure VII-23. Vortex boulder weir, plan view (Rosgen, 1993).

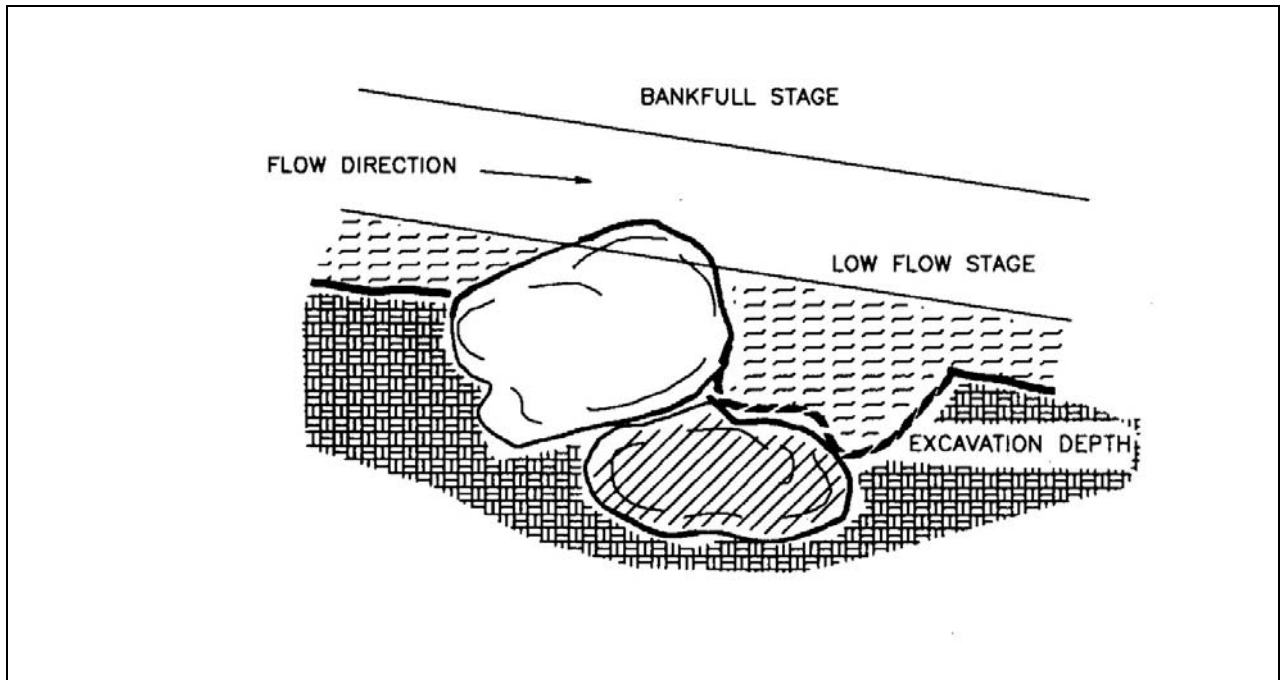

Figure VII-24. Vortex boulder weir, profile view (Rosgen, 1993).

CALIFORNIA SALMONID STREAM HABITAT RESTORATION MANUAL

Boulder Clusters

Boulder clusters are used to create scour pockets around boulders, to provide rearing habitat for juvenile salmonids, to build quiet water resting areas for upstream migrating spawners, and to sort spawning gravel (Figure VII-25).

Generally, clusters are located in straight, stable, moderately to well confined, low gradient riffles (0.5 to 1 percent slope) for spawning gravel enhancement; they are also placed in higher gradient riffles (1 to 4 percent slope) to improve rearing habitat and provide cover. At least 3 to 5 foot diameter boulders are recommended, except in very small streams.

To be effective in creating scour pockets and habitat niches around individual boulders, the correct distance between adjacent boulders and the configuration of the boulder clusters must be determined. In general, adjacent boulders should be 0.5 to 1 foot apart. The best configuration for boulders is usually a triangle of three boulders. Several of these clusters may be aggregated to increase scour area and create greater habitat complexity.

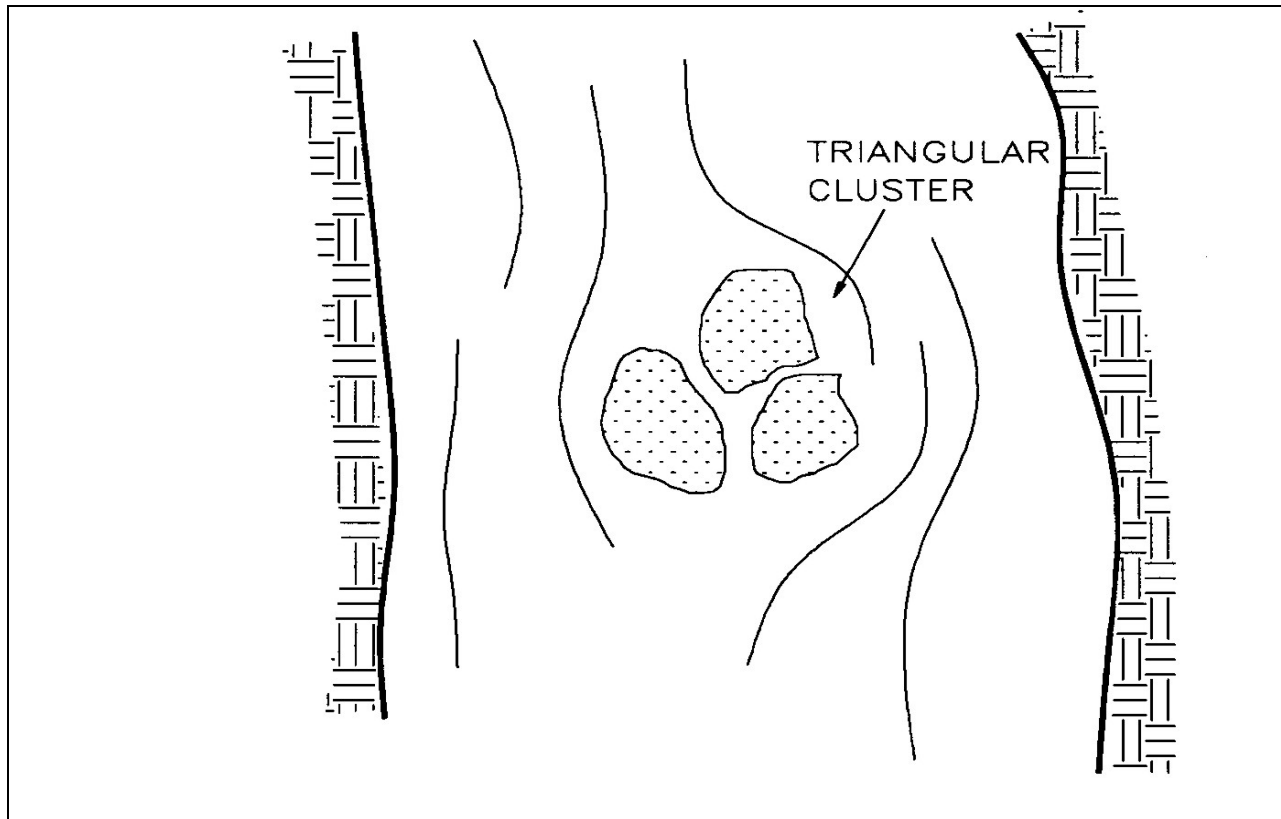

Figure VII-25. Boulder cluster.

If large angular quarry boulders are available, a single boulder can create good cover for juvenile and adult fish. Place the boulder within the middle two quarters of channel width, and not in a deposition zone. If the boulder is placed on a sand or silt bar, it may disappear into the bar. Do not use boulders that are so big that they divert the stream from its channel, or into soft stream banks.

CALIFORNIA SALMONID STREAM HABITAT RESTORATION MANUAL

Single and Opposing Boulder Wing-Deflectors

Single wing-deflectors are built to protect a portion of one bank, by deflecting the flow away from the bank. They are also used to create scour by constricting the channel thereby accelerating the flow (Figure VII-26). Wing-deflectors can also create quiet water resting areas for use by upstream migrating spawners.

Opposing wing-deflectors are built to constrict the flow to create a scour pool and sort spawning gravel. These structures are best installed in long, uniform glides or riffles. They create rearing habitat for juvenile salmonids as well as resting areas for upstream migrating spawners. The upstream side of the deflector will develop deposition that may become suitable spawning habitat.

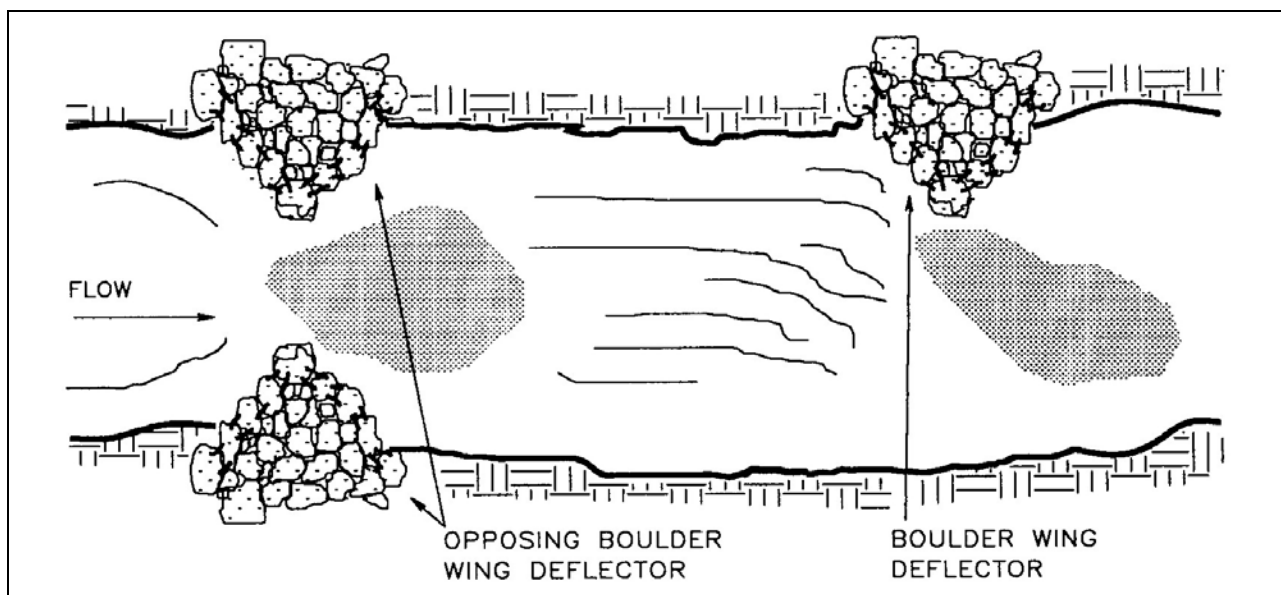

Figure VII-26. Single and opposing boulder wing-deflectors.

Wing-deflectors are similar to boulder weirs in that they are keyed into the stream banks, and slope to a low point near the center of the channel. Opposing wing-deflectors are created by constructing two single wing-deflectors opposite each other, reducing channel width by 40 to 80 percent. They should be constructed in low profile and their apexes should be equal in height.

Wing-deflectors are built in a triangular shape. This configuration will more effectively funnel flows between the apexes of opposing wing-deflectors, or to the apex of a single deflector.

Size of boulders will depend on the size of the channel, but oversized boulders are usually not a problem. To maintain the integrity of the structure it is desirable to secure the boulders with cable and polyester resin adhesive to create the perimeter of the structure. Smaller boulders or cobble can be used to fill the interior. The stream banks must either be naturally resistant to erosion or bank protection should be incorporated in construction of wing-deflectors.

CALIFORNIA SALMONID STREAM HABITAT RESTORATION MANUAL

Log Structures

Applications for log structures are similar to those for boulder structures. Logs may be used to provide instream cover for juvenile salmonids and spawning adults, to scour pools for rearing habitat, to recruit spawning gravel, and to stabilize eroding stream banks.

Log structures have a variety of shapes and uses. These include straight log weirs, downstream-V weirs, diagonal weirs, upstream-V weirs, upsurge weirs, wing-deflectors, divide logs, digger logs, and Hewitt ramps. The various structures have specific purposes which often dictate the specifications to which they are built. Many of these structures serve the dual purpose of trapping, sorting, and stabilizing gravel for spawning habitat as well as creating scour pools which act as rearing habitat for juvenile salmonids and escape cover or resting areas for spawning adults.

Log Weirs

As with boulder weirs, log weirs must be designed to specifications dictated by channel dimensions and range of flows that the stream may experience. It is important that log weirs are designed so that they do not become low-flow migration barriers. The maximum jump height that a log weir should create is 12 inches.

Log weirs are often placed in long, shallow riffles or runs. They may also be installed on straight reaches or meanders. The gradient should be between 1.5 and 4 percent in a moderately entrenched channel. Stream banks should be stable and composed of coarse, resistant material.

Log weirs have advantages and disadvantages compared to boulder weirs. The advantages are that logs are often available near the channel and are often obtainable at no cost other than the labor to bring them to the project site. A disadvantage of logs is that they will eventually rot, making the structure less durable than one of boulders. Redwood and cedar logs, however, can last for decades in a stream, are aesthetic, and are easy to work with.

Log weirs can be built in a variety of configurations. The type of log weir constructed is dependent on the desired habitat modification. Straight log weirs have been used extensively throughout the California coastal mountains. Constructed properly, they will trap gravel upstream and scour a pool downstream. Several problems have been associated with straight weir design. Straight log weirs can push too much water to sides, eroding fragile banks. Where there is not a proper downstream control, down-cutting immediately below the weir may create a jump in excess of 12 inches and a low-flow notch will be required (Figure VII-27). Generally, the only purpose for a straight log weir is to back-flood an area, such as a culvert. Downstream-V and diagonal weirs are more efficient at trapping gravel and upstream-V weirs are better for scouring pools.

**CALIFORNIA SALMONID STREAM
HABITAT RESTORATION MANUAL**

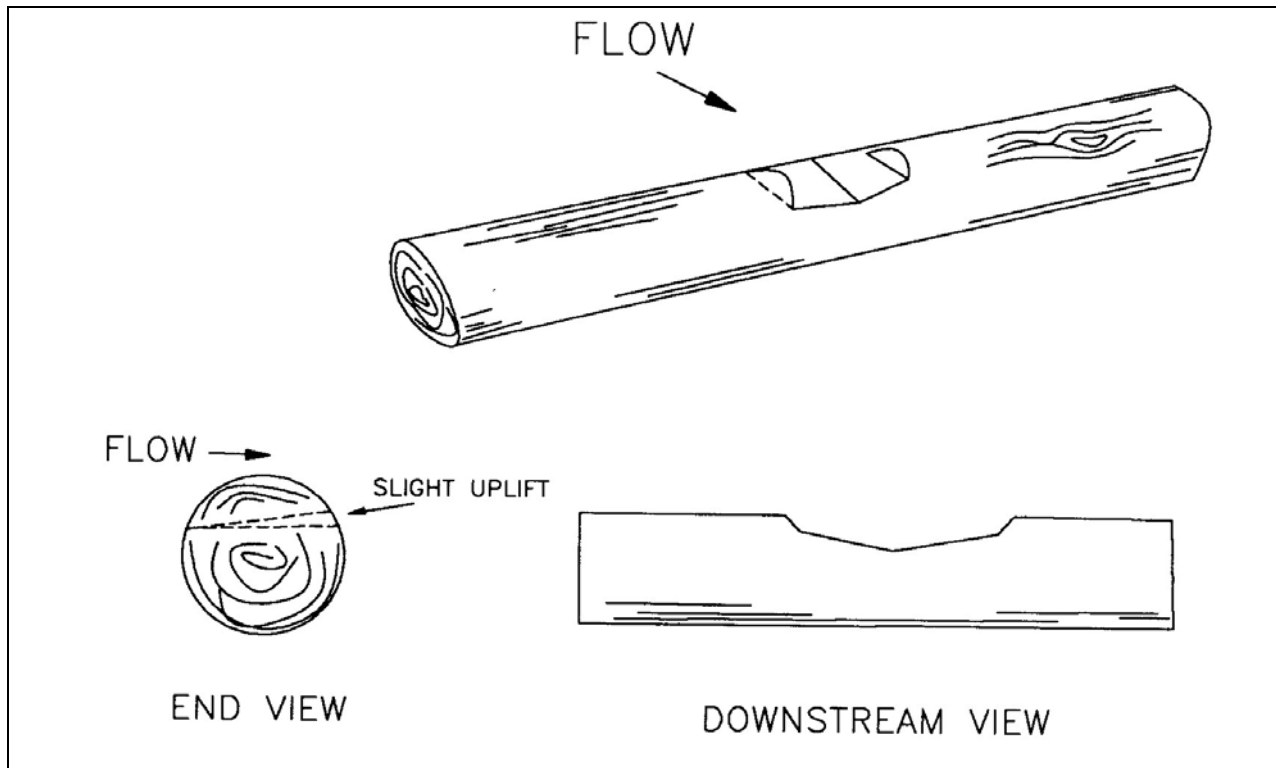

Figure VII-27. Straight log weir with low-flow notch.

Downstream-V weirs are effective in dissipating high flow energy and are used to collect spawning gravel. The downstream design forces water to the banks, therefore downstream-V weirs should only be constructed in areas of good bank stability (Figure VII-28).

Diagonal log weirs are placed diagonally to stream flow and span the full channel width. The upstream end of a diagonal log weir is set at a lower elevation than the downstream end. The drop in elevation should be approximately 6 inches in 10 feet. Diagonal log weirs cause stream flow to adjust direction so flow comes off the log at a right angle. Diagonal log weirs are good for creating lateral scour pools on river bends and for collecting spawning gravel, and they are also used to adjust direction of the stream. They can be very useful in directing flow away from unstable banks (Figure VII-29).

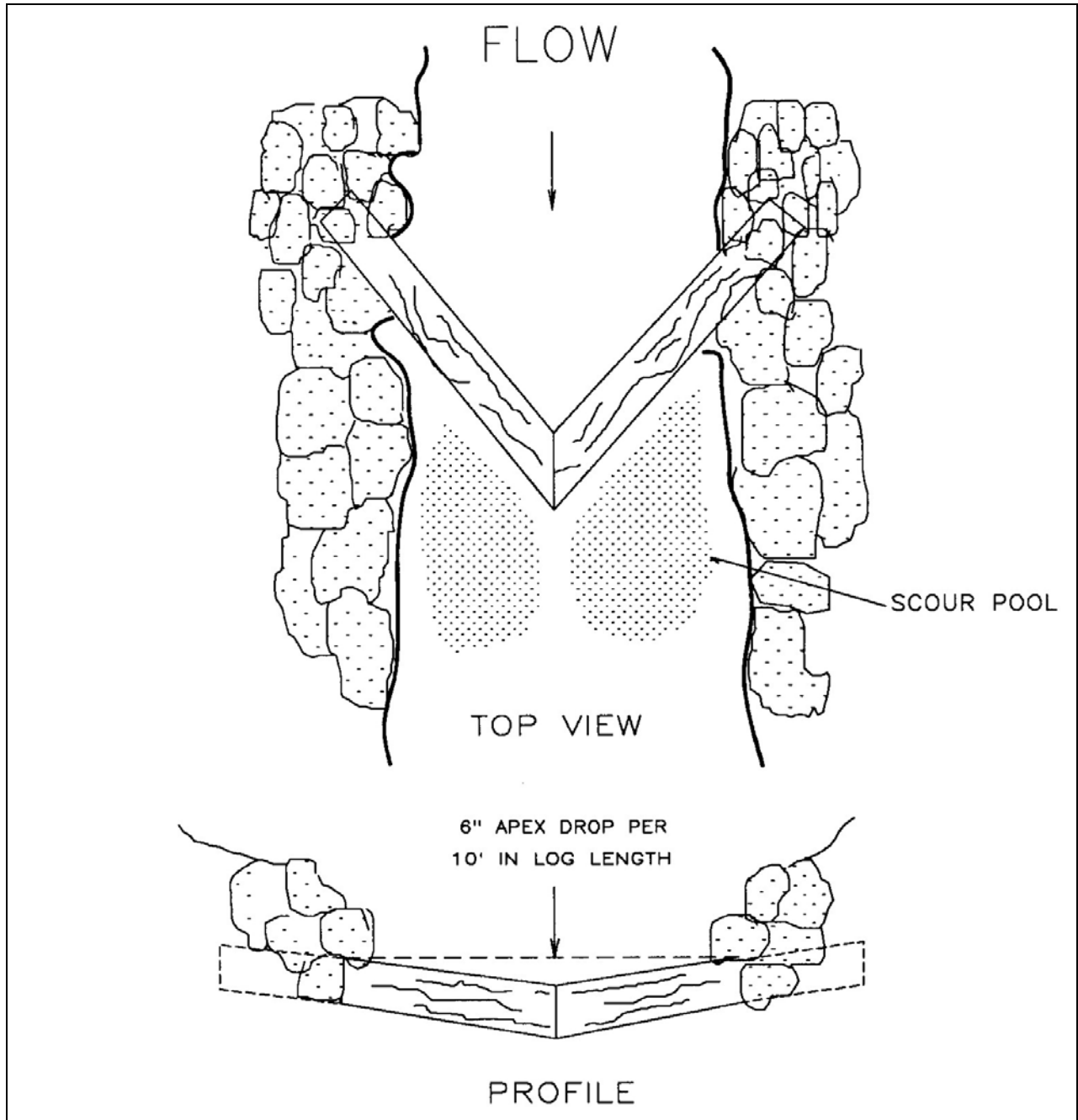

Figure VII-28. Downstream-V log weir.

CALIFORNIA SALMONID STREAM HABITAT RESTORATION MANUAL

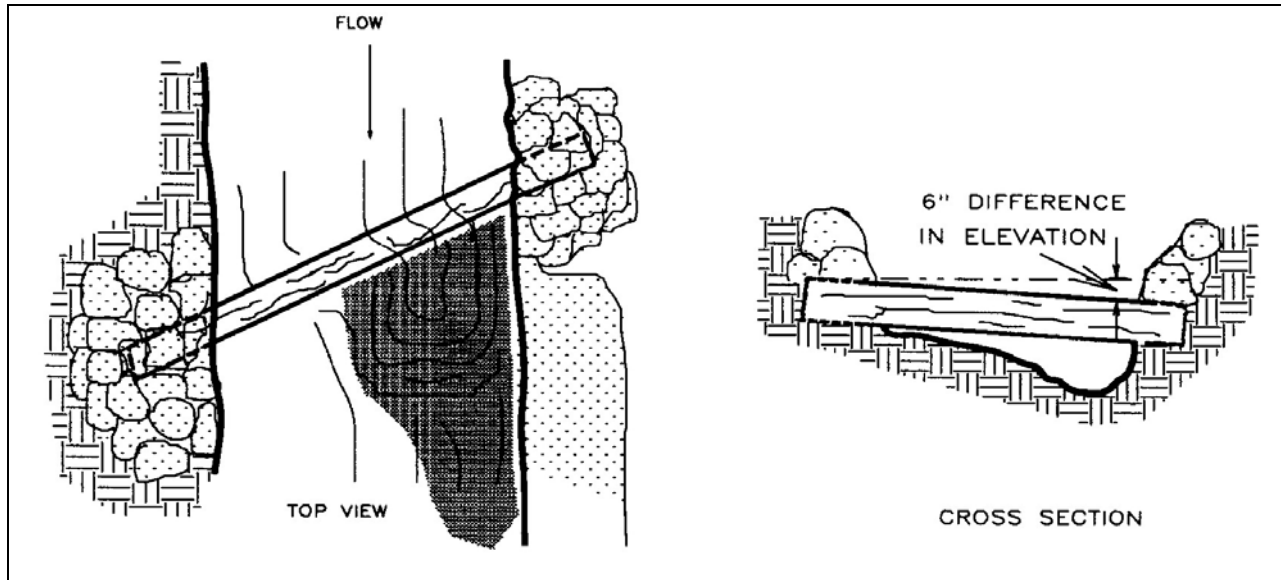

Figure VII-29. Diagonal log weir.

Upstream-V log weirs are used to scour deep pools. Principles of construction are the same for the various shapes of log weirs. Construction of an upstream-V weir will be described. These techniques of construction apply to other log weirs with some variations required to accommodate differences in configuration (Figure VII-30).

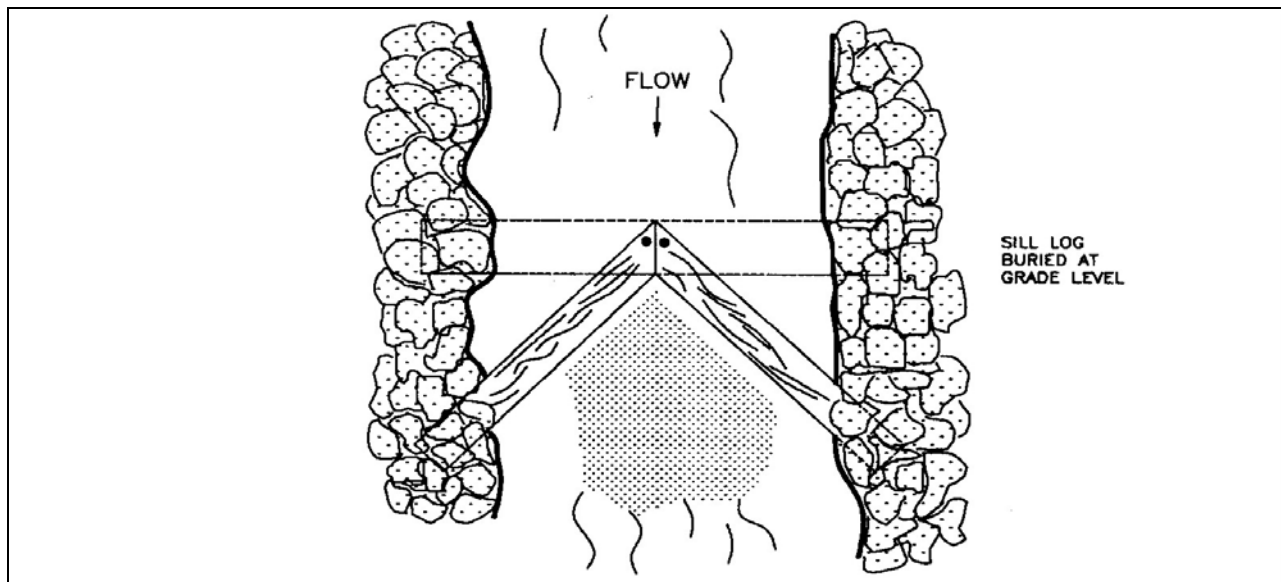

Figure VII-30. Upstream-V log weir.

Use redwood or cedar logs if available. Logs should be of appropriate size, determined by channel width, channel type, and bankfull discharge flows. Dig a trench perpendicular to the channel to bury the sill log at streambed grade. Key the ends of the sill log at least 6 feet into the bank. Place rock on keyed section of the log to prevent it from floating loose. Rock must be large enough and in sufficient quantity to protect banks.

CALIFORNIA SALMONID STREAM HABITAT RESTORATION MANUAL

Place the apex ends of the two logs forming the upstream "V" on top of the sill log. The two logs are placed so the apex is approximately 6 inches lower than the downstream keyed-in ends of the logs. The top of the logs at the apex should be no higher than 12 inches above the downstream water line. The apex of the logs must be shaped for a close fit. Drill through the apex ends of the two logs into the sill log, and hammer lengths of one-inch threaded rebar through both drill holes. Secure washers and nuts to the ends of the threaded rebar and tighten securely. Armor the bank ends of the logs with rock. Dig a 24-inch deep pool at the downstream apex so that fish can jump over the logs until high flows can create a scour pool.

If a series of weirs is to be installed, the downstream weir should be constructed first. Difference in elevation between lower and upper water surfaces should be 12 inches. Elevations can be determined with a hand or survey level and a stadia rod.

There are numerous variations of the upstream-V log weir. These include the upstream-V leaving a low-flow notch (Figure VII-31), the upstream-V using opposing log deflectors over a sill log (Figure VII-32), and log constrictors over a series of log planks (Figure VII-33).

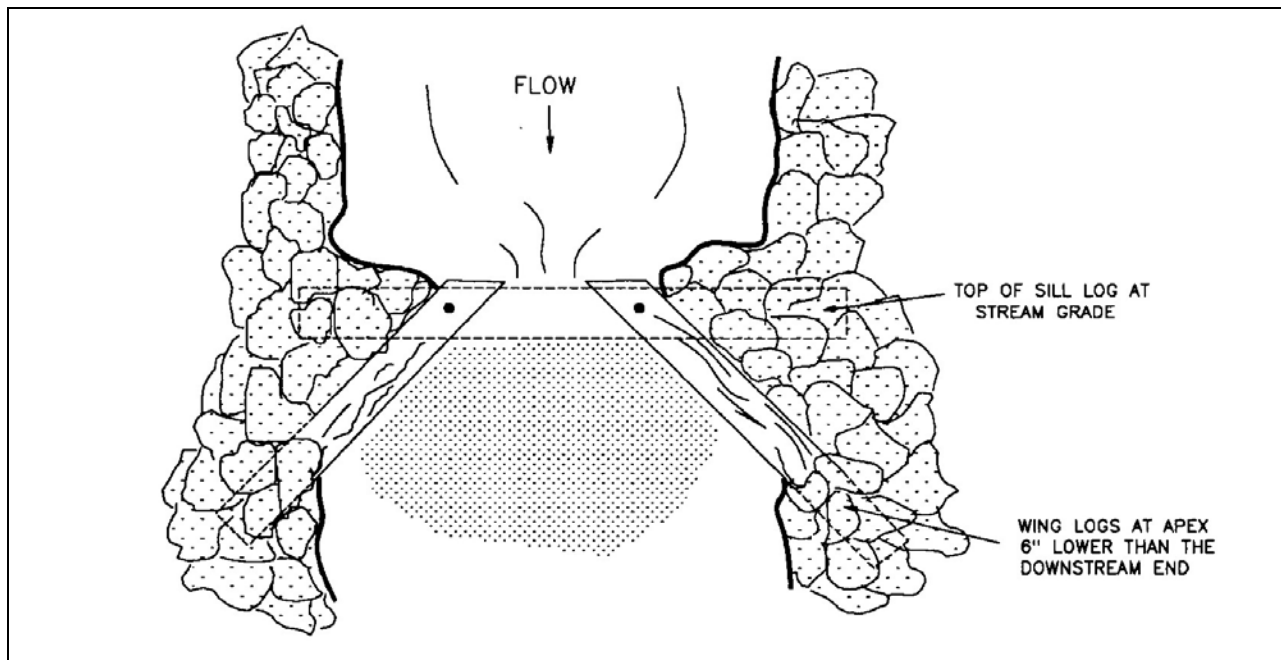

Figure VII-31. Upstream-V log weir with a low-flow notch.

**CALIFORNIA SALMONID STREAM
HABITAT RESTORATION MANUAL**

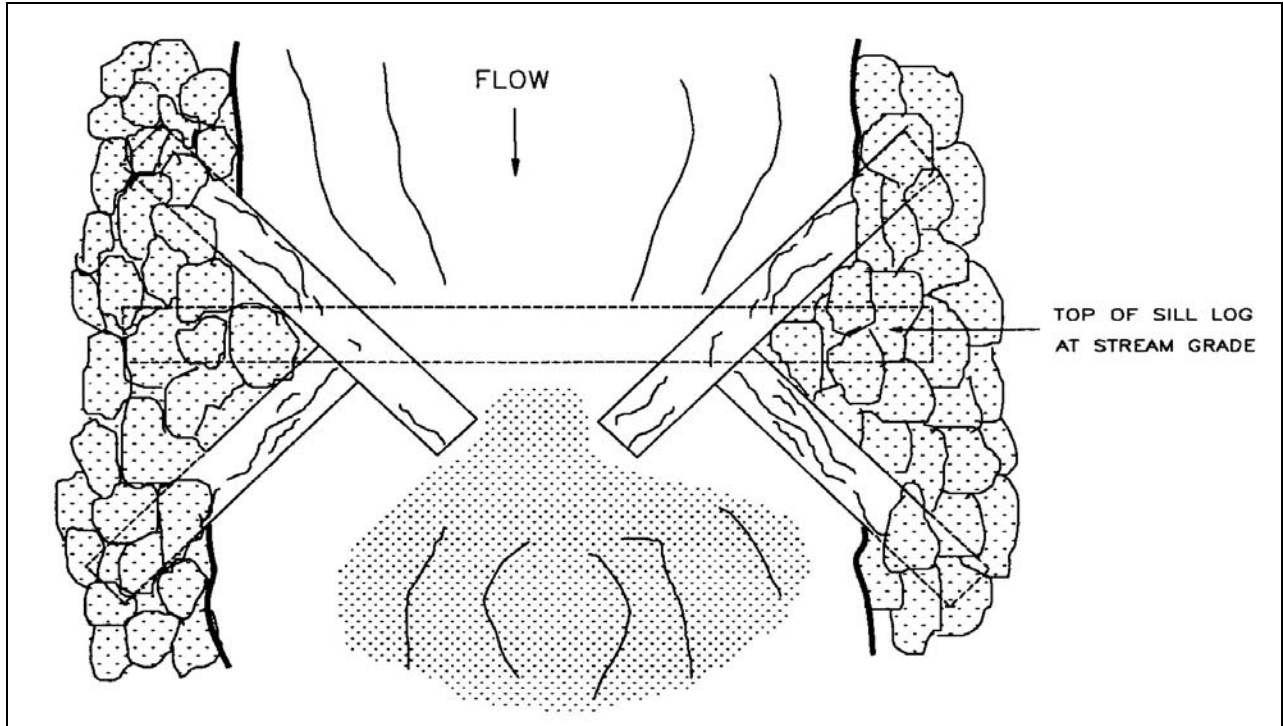

Figure VII-32. Upstream-V log weir with a low-flow notch.

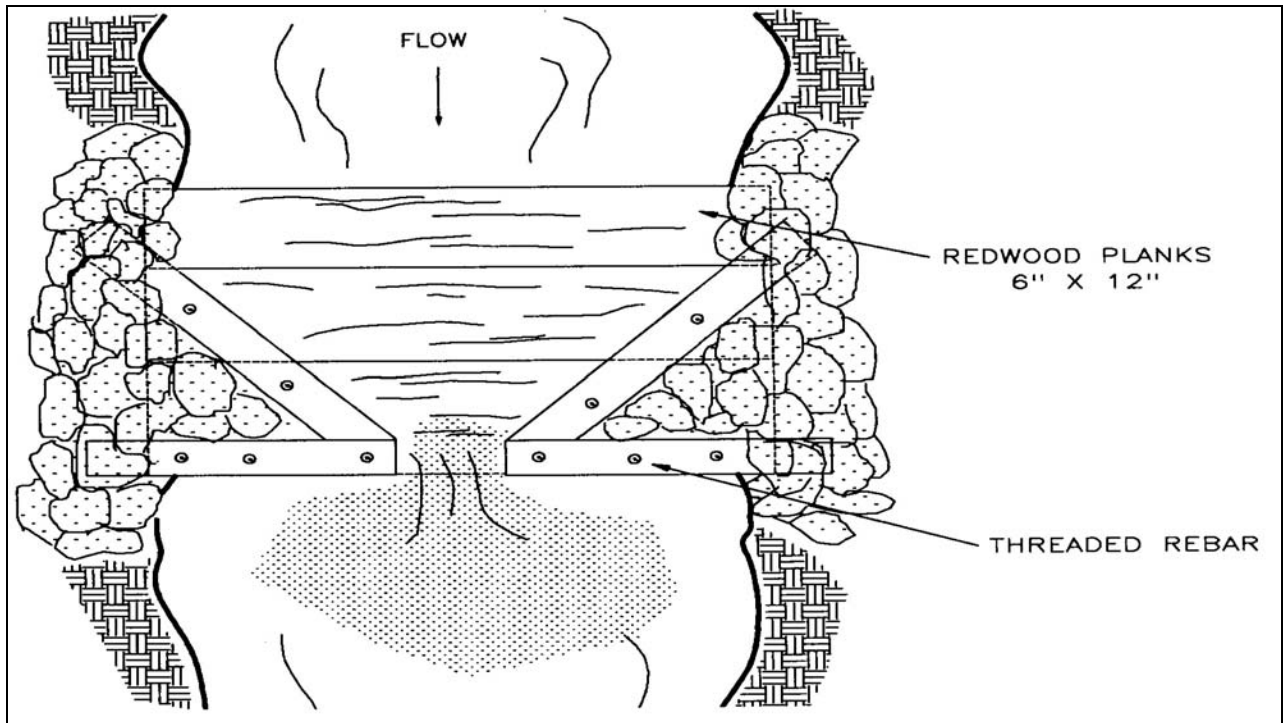

Figure VII-33. Log constrictors over planks.

CALIFORNIA SALMONID STREAM HABITAT RESTORATION MANUAL

Upsurge Weirs

Upsurge weirs are logs which span the full channel width. They are used to force stream flow under the log in order to scour the channel bottom to create or enhance pools for summer rearing habitat. Upsurge weirs are most effective when the bottom of the log is placed at the summer low-flow surface elevation (Figure VII-34).

Strong anchoring systems are required for upsurge weirs because of the strong hydraulic lifting force generated at scouring flows. Upsurge weirs should be anchored to stationary boulders on the banks or to bedrock. If this is not possible, both ends of the weir can be set into excavated trenches on opposite banks at the summer low-flow water level. Four to six feet of the log should be keyed into each bank. Enough weight must be placed on each log end to permanently secure it.

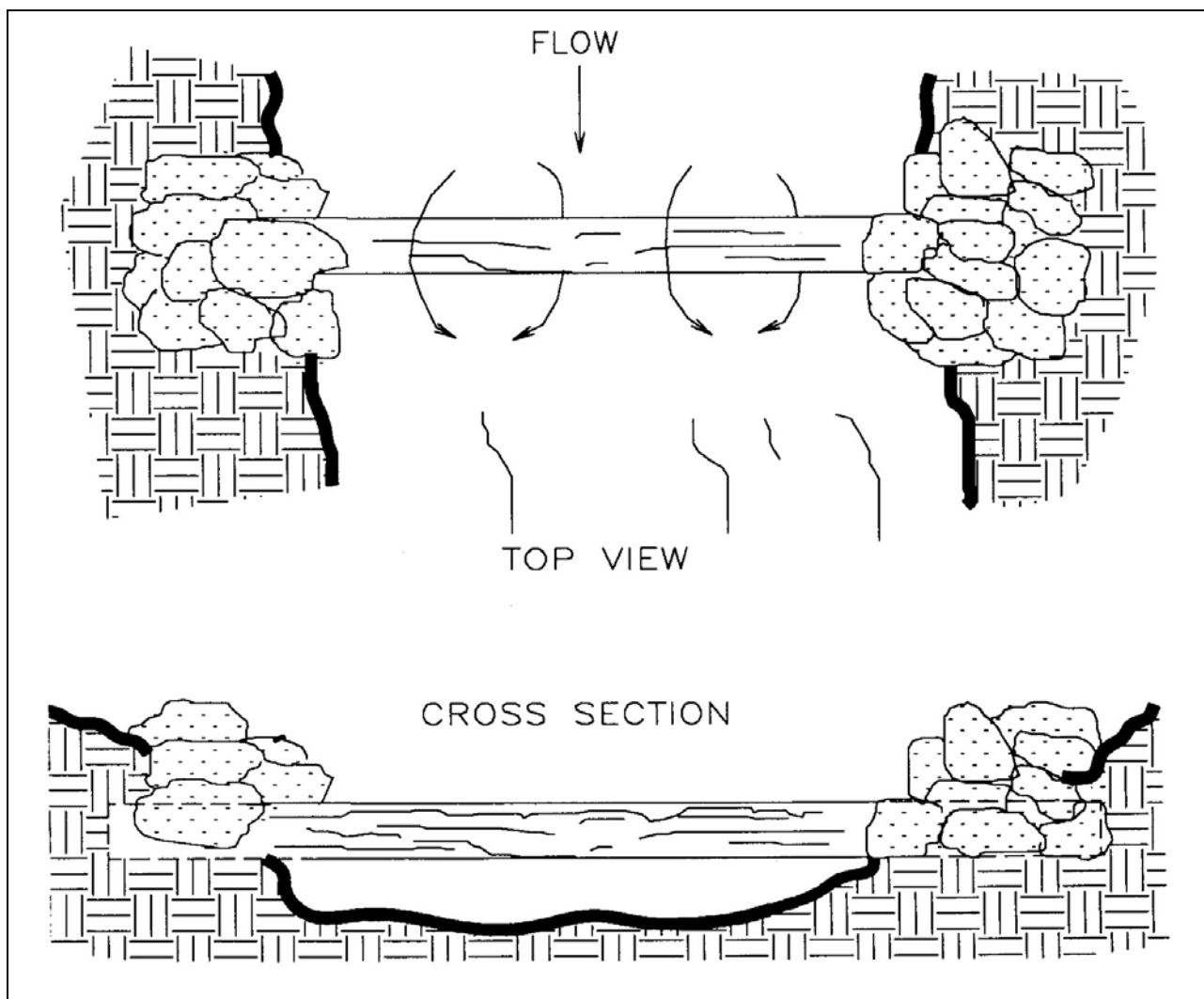

Figure VII-34. Upsurge weir.

CALIFORNIA SALMONID STREAM HABITAT RESTORATION MANUAL

Single and Opposing Log Wing-Deflectors

Wing-deflectors are used to concentrate the flow of water into a selected area of the channel to create scour. The scour creates a pool and the deflector(s) will act as cover and create a resting area for fish. They are primarily used in areas of long, uniform glides or riffles to diversify habitat and create velocity shear zones (Figure VII-35).

Wing-deflectors must not be placed or designed so that they create a severe channel constriction or deflect high flows into unstable or unprotected stream banks. The upstream log should extend into the summer low-flow channel so that it provides summer rearing habitat.

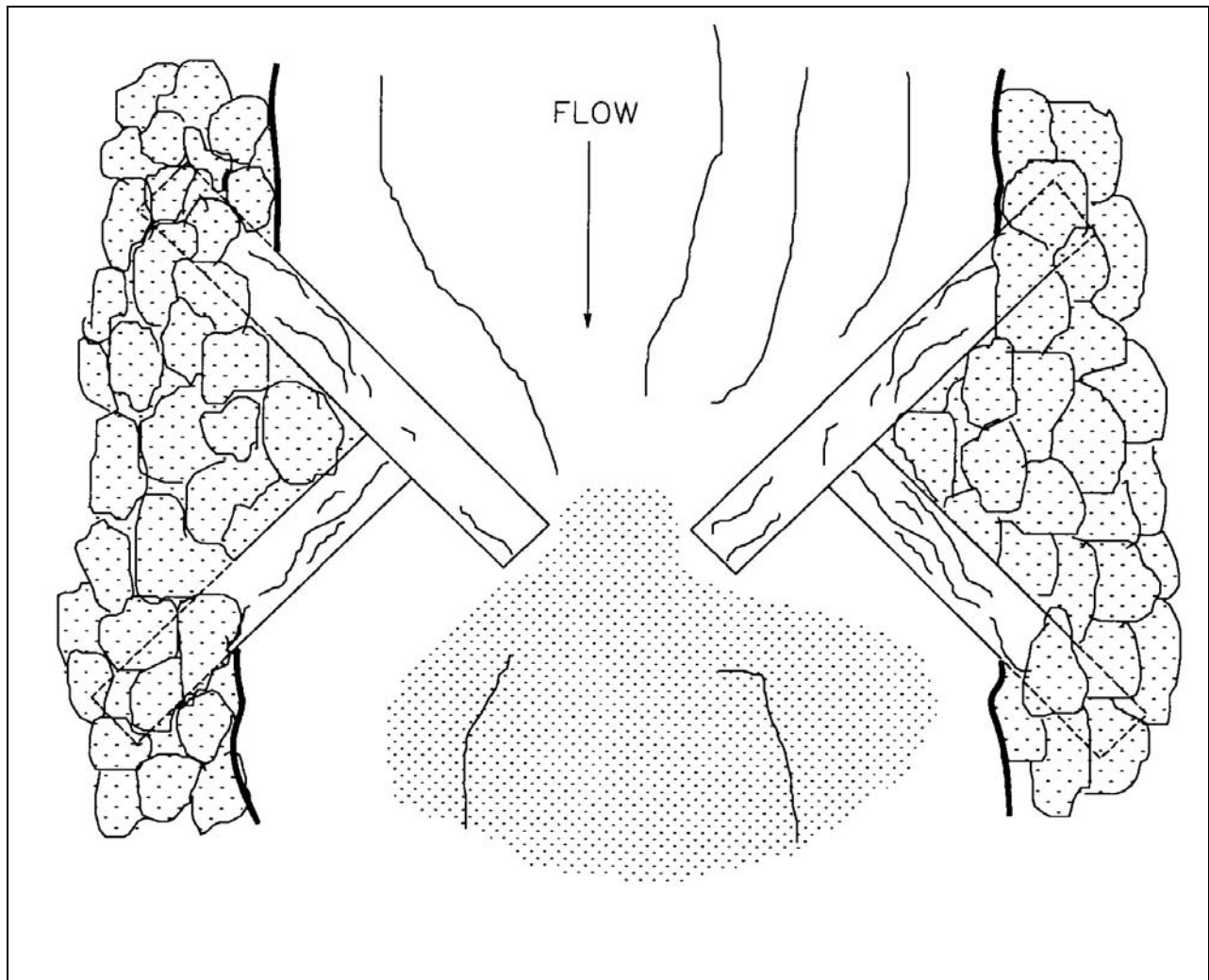

Figure VII-35. Opposing log wing-deflector.

The construction of the deflector involves making a "V" or a triangle whose base is parallel to the bank and whose two sides join to make the apex, which extends into the flow. A trench must be excavated into the bank to key-in the logs that make up the sides of the triangle. The trench must extend far enough into the bank to afford adequate anchoring for the deflector side logs. The angle of this trench will determine the angle at which the deflector sits. Orientation of the trenches will be determined by the desired apex angle. The apex angle will be 100 to 120

CALIFORNIA SALMONID STREAM HABITAT RESTORATION MANUAL

degrees. Location of the apex should be determined and the trenches should be laid out to conform to the desired angle of slope and the apex angle.

The ends of the side logs must be notched so that they fit together to create a joint that is the same diameter as the side logs (the top of the apex joint should form a smooth transition to either log). One log end (the one pointing downstream) can be extended past the apex to create scour and additional cover. The apex is held together with threaded rebar inserted through a hole drilled in the apex.

The base of the triangle parallels the bank. A smaller diameter log can be used to join the two sides of the apex. This will give the structure added strength, but if the bank ends of the logs are adequately anchored, the base log may not be needed.

Once logs are placed in their trenches and the ends have been joined to make the apex, the bank ends should be secured to trees, stumps, boulders, or a deadman, then covered with boulders to weigh them down and act as anchors.

If opposing deflectors are installed, the distance between the apexes is important. This distance will determine velocity of water flowing between the deflectors and the amount of scour created. Opposing wing-deflectors typically should reduce channel width by 40 to 80 percent.

Hewitt Ramps

Hewitt ramps are constructed by installing base logs that support cedar or redwood planks. Planks are placed on the upstream side of the base log at an angle that will allow gravel to wash over the structure, creating a plunge pool on the downstream side of the structure. They are used to create pools in areas where there is a large volume of bedload movement. Construction costs for Hewitt ramps are high and the structures usually require periodic maintenance. Hewitt ramps must have a low profile or other design features to avoid creating a barrier to fish migration (Figure VII-36).

A Hewitt ramp is constructed with a base log placed in a trench excavated in the stream to one-third the log diameter. This log is secured by burying its ends in the stream banks. The log should be at least two feet in diameter. On the upstream side of the log, cedar or redwood planks (2 x 6 inch minimum) are laid to create a ramp at an angle of 30 to 45 degrees. Planks are set against each other and the ends are buried in the substrate to a depth of at least two feet. The area between the planks and the log should be filled with cobble to provide extra support for the planks. Tops of the planks are nailed to the log with 20d galvanized nails. The planks are cut off in a "V" configuration to concentrate stream flow into the thalweg during low flow conditions.

CALIFORNIA SALMONID STREAM
HABITAT RESTORATION MANUAL

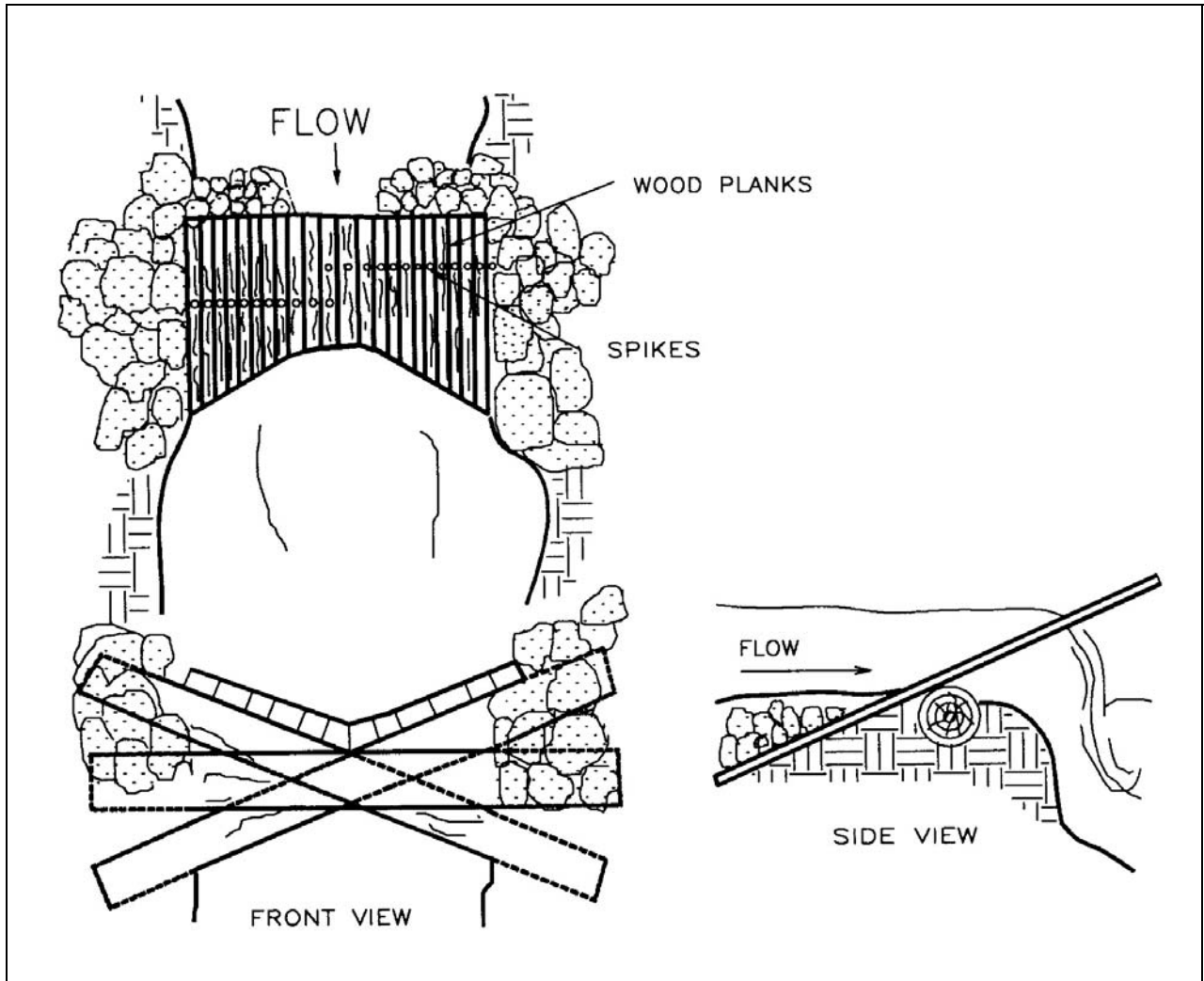

Figure VII-36. Hewitt ramp.

CALIFORNIA SALMONID STREAM HABITAT RESTORATION MANUAL

Placement of Imported Spawning Gravel

In streams that are deficient in spawning gravel, either naturally or because of artificial structures which prevent gravel recruitment or transport, addition of spawning size gravel may be beneficial. Several techniques may be used.

Gravel may be placed upstream of weir installations to a depth of about 18 inches. Spawning gravel for salmon should be clean, creek-run from 2 inch to 4 inches in diameter. Gravel would normally be dumped at a staging area on the bank and then picked up and placed with a front-end loader or hydraulic excavator.

In some streams that have high levels of fine sediment transported at normal flows, or in many streams after a high flow or watershed disturbance, fine sediment may be deposited in spawning gravel substrates. Therefore, periodic maintenance might be required to reduce fine sediment in spawning areas. This usually is done by plowing the gravel with a ripper attachment on a tractor and adding fresh gravel. Ripping is also an excellent technique for improving quality of natural spawning riffles infiltrated by fine sediment. Watersheds that have high levels of fine sediment yield should be treated to control the sediment source, if possible, before gravel seeding is considered as a project.

Gravel may be spread on spawning riffles without control weirs. This normally is appropriate where a dam or other artificial structure has blocked natural downstream movement of gravel, and gravel from once-productive spawning riffles has been washed away. It may be advisable to scrape off some of the armoring layer of cobble before fresh gravel is added. This technique should only be used in reasonably stable riffle areas, or there is an unacceptable risk of having the eggs and gravel wash downstream with high flows after fish use the gravel for spawning.

Sometimes, spawning habitat can be improved by simply dumping gravel in an area of high water velocity and allowing the stream to distribute the gravel downstream during high flows. An area of active bank erosion is usually a good site for this technique because the stream has demonstrated the ability to move substrate material. The project may also provide temporary protection for the bank until the gravel is washed away.

Fish Screens

Unscreened water diversions have been recognized as a serious problem for California's salmonid populations since the early 1900's. As a result, screens have been used to prevent entrainment of juvenile salmonids in water diverted for agriculture, power generations, or domestic use since the 1920's, and are needed on both gravity flow and pump diversion systems. Through the years, fish screen technology has improved dramatically, and high performance, low maintenance designs are now available. Screening criteria by DFG and NMFS (Appendix S) has established specifications which must be included in fish screen designs. This criteria requires water diversion screens to complete a barrier to salmonid entrainment.

Currently, most fish screens consist of perforated metal plate, or mesh material, with openings sized to prevent entrainment of juvenile salmonids. Screen systems that utilize light,

CALIFORNIA SALMONID STREAM HABITAT RESTORATION MANUAL

electric fields, sonic systems, and bubble curtains as barriers have been tested, but are not adequate. Screens utilize debris cleaning devices, typically brushes, water jets, or compressed air to prevent them from plugging. Bypass routes return fish to the stream channel. Normally a flow measuring device and head gate are required to monitor and control diversion flows. Screen designs are complex and site specific, and many require professional engineering; therefore, none are included in this manual. Consultations with staff from DFG fish habitat improvement shops and NMFS are recommended to determine fish screen suitability at a proposed diversion site.

FISH PASSAGE

Obstructions to upstream migration frequently restrict distribution of salmonids. When barriers to fish movement exist, reaches downstream of the blockage may become overcrowded with spawners or juvenile fish, while suitable areas upstream lie unused. Even a partial obstruction, which only poses a barrier under certain flow conditions, can be a serious problem.

Increasing the use of spawning and nursery areas above natural and human-induced obstructions is a sound approach to restoration which has met with considerable success. A note of caution that must be included, however, is: avoid situations in which newly created access for one species results in competition with a species or population already established in the area above the obstruction. Possible species interactions might include steelhead versus non-anadromous rainbow trout, or coho salmon versus established populations of cutthroat or steelhead trout. Competition with the introduced species may reduce the population of the established species or population.

The key physical characteristics of the stream which inherently affect salmonid migration should be understood before any attempt is made to remove or modify an obstruction. Low waterfalls (less than six feet), cascades, and chutes in natural watercourses can affect fish migration in several ways. When water drops vertically into a pool of depth at least 1.25 times height of the drop, fish have very little difficulty jumping over a low obstruction. The upwelling water, or Astanding wave@ created by flow plunging into the pool will actually assist fish by imparting an upward force as a fish leaps from the pool. However, an incline or chute can form a hydraulic jump further downstream; encouraging fish to jump too far from the crest of the drop (Figure VII-37).

CALIFORNIA SALMONID STREAM HABITAT RESTORATION MANUAL

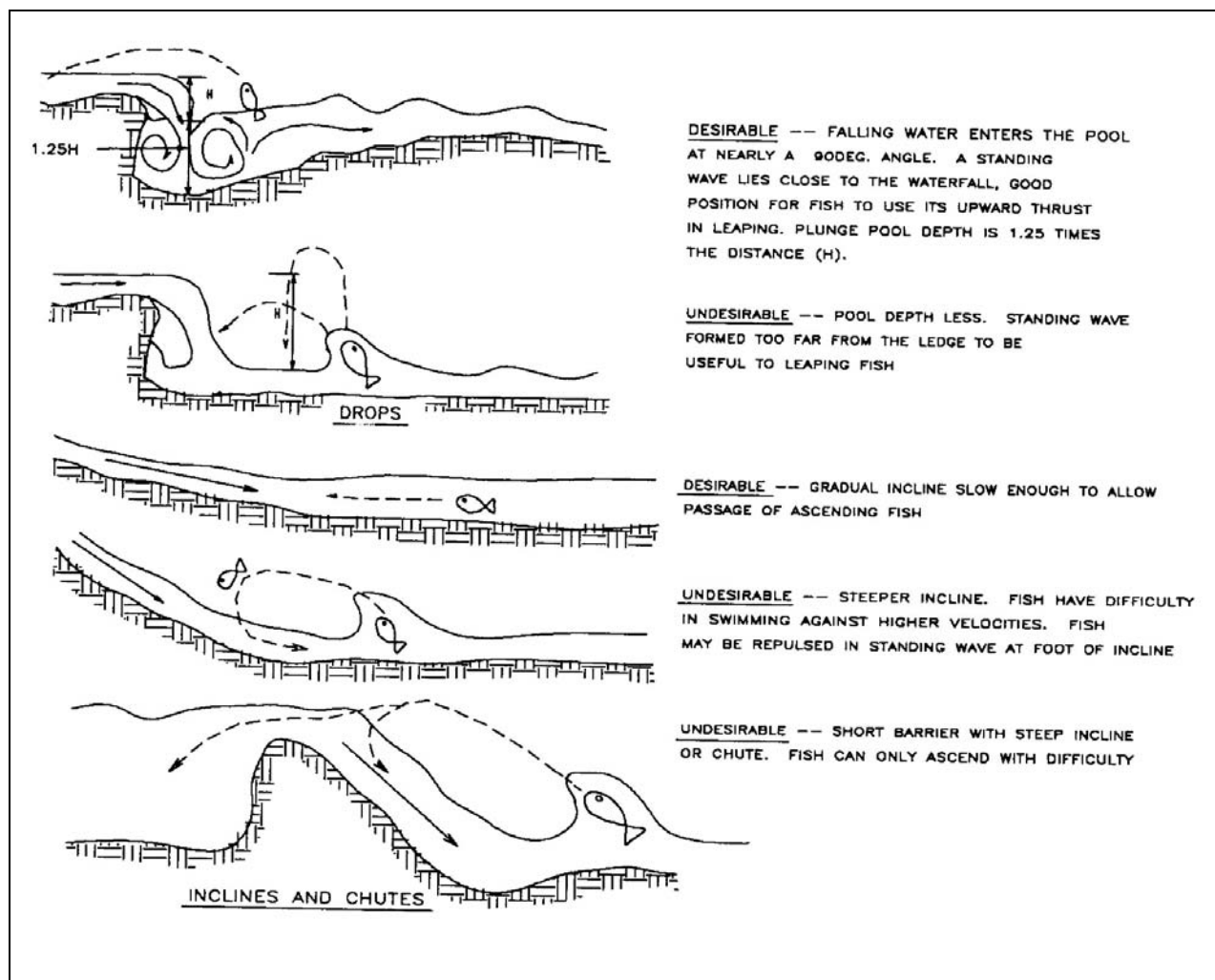

Figure VII-37. Movement of fish over natural obstacles (*Stream Enhancement Guide*, British Columbia Ministry of Environment, 1980, p. 27).

Obstructions

Natural obstructions to fish movement include waterfalls, chutes, logs and debris accumulations, and beaver dams. Any of these can create total or selective barriers. Often these barriers can be modified to provide fish passage, but regarding both log jams and beaver dams, care must be taken to preserve their rearing habitat benefits as well as to provide upstream passage. Removal of any natural obstruction during salmonid egg incubation may cause loss of the redd through silt deposition or changes in flow characteristics. Except for emergencies, any work to remove natural obstructions should be completed during low-flow periods outside the spawning or incubation season.

CALIFORNIA SALMONID STREAM HABITAT RESTORATION MANUAL

Log Jams

Log or debris jams can be either human-induced or a natural feature. It is sometimes difficult to establish whether or not a log jam is blocking migration. Often, a log jam which appears impassable has stable underwater passages for migrating fish. Careful surveys for salmonids, especially fry, above suspected jams should be conducted prior to any treatment. Large woody debris accumulations are preferred rearing habitat for steelhead trout and coho salmon because of the excellent cover they afford. Large stable pools created by log jams also provide important holding areas for adult salmonids.

Log and debris jams which become plugged with silt, gravel, fine debris, or other materials can form an impassable barrier or block flow and create a waterfall. In some cases, water diverting around log jams can create detrimental bank erosion. If a jam is creating an impassable barrier or creating erosion, modification of the log jam is desirable. In all instances, only the minimum amount of wood necessary to facilitate fish passage, or to eliminate a stream channel problem, should be manipulated.

The fastest and most efficient way to modify a log barrier is with heavy equipment. A self-propelled logging yarder, with a high lead, is most desirable. Hydraulic excavators are also useful. When this equipment is not available and access into the site is poor, manual labor, combined with a chain saw and grapple operation, can satisfactorily modify log jams.

Beaver Dams

Beaver dams, like log jams, create benefits for salmonids as well as problems. Rearing juveniles, especially coho, use beaver ponds extensively. In addition, the pond can store water to help stabilize stream flow, augment the groundwater contribution to a stream's base flow, and reduce peak flows during freshet conditions.

Only when determined to be a problem, after thorough consultation with fish and wildlife personnel of the California Department of Fish and Game, should beaver dams be modified. If required, beaver dams can be altered with simple hand tools, a small backhoe, or by blasting.

Where frequent inspection of the beaver dam is possible, it is preferable to maintain an opening for fish passage over the crest of the dam. This results in a minimum of damage to the downstream areas, while still maintaining beneficial aspects of the impoundment.

Beavers are hard-working and persistent animals. When either a portion or all of a beaver dam is removed, the beaver family will normally attempt to restore the damaged structure. They often succeed.

CALIFORNIA SALMONID STREAM HABITAT RESTORATION MANUAL

Waterfalls and Chutes

Waterfalls and chutes can create fish migration barriers. Blasting to provide fish passage is usually the preferred method of altering waterfalls and chutes. Resting pools can be blasted into bedrock, forming a step-and-pool access (Figure VII-38).

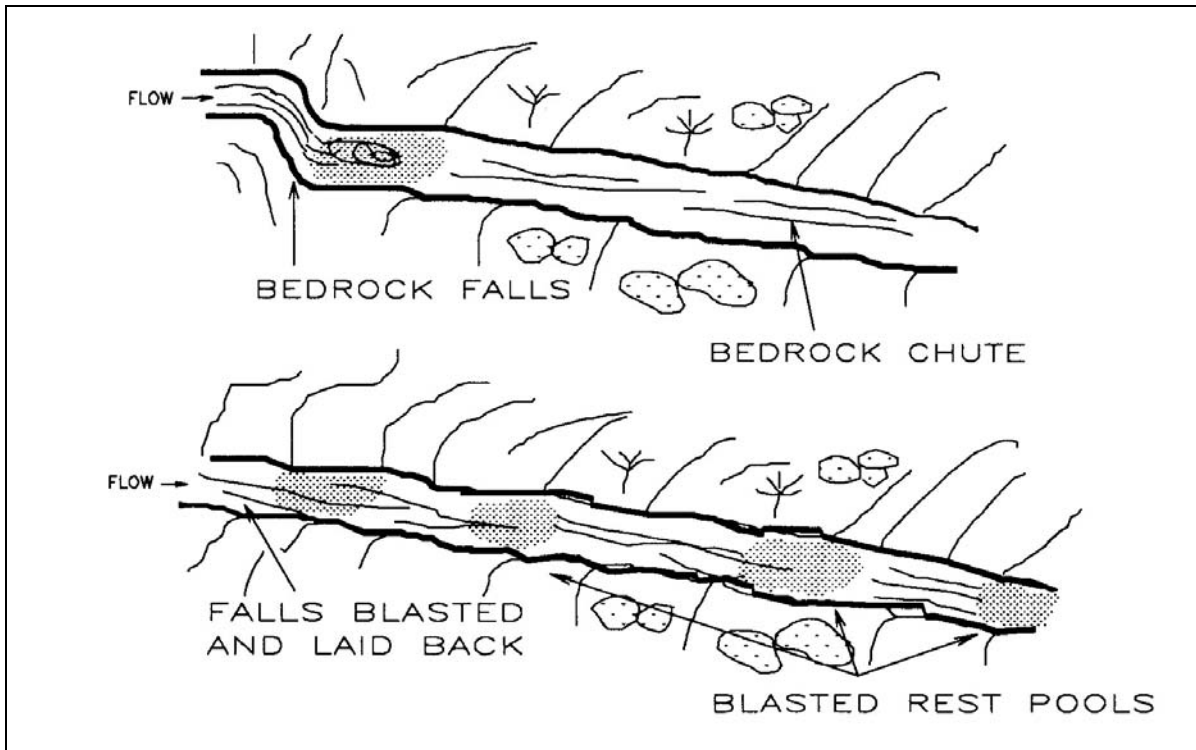

Figure VII-38. Before and after blasting of falls and bedrock chute.

Where a chute is causing a velocity barrier, it is sometimes possible to widen the chute by blasting to decrease the water velocity. Blasting can also be used to lower waterfalls. All blasting must be performed by a State of California, Division of Occupational Safety and Health, licensed blaster.

In some instances, use of log, boulder, or cement weirs to decrease velocity and back-flood a chute or waterfall is possible. As a last resort fishways can be installed to create fish passage.

Landslides

Landslides often occur during fall and spring freshets, which may also coincide with major fish migrations. If possible, slides should be removed or remedial work carried out immediately to avoid harmful effects on fish. If the slide is big enough, large earth moving equipment may be required to completely remove the obstruction.

Not all landslides require use of heavy equipment or large amounts of capital to improve fish migration. Often, in small landslides, selective removal or relocation of boulders and debris by hand crews, using steel rock bars or grapplehoists, can provide fish passage through or around an obstruction.

CALIFORNIA SALMONID STREAM HABITAT RESTORATION MANUAL

Large boulders may be reduced to a size that can be readily moved using a portable gasoline-powered rock drill and feather and wedges (hand rock-splitting tools). This may also be done with explosives, if a qualified blaster is available.

If it is not feasible to remove the obstruction, a possible alternative might be the use of a temporary step-and-pool fishway over or around the obstruction. This can be constructed using rock and debris from the slide. Often, selective blasting combined with handwork will provide a satisfactory fishway.

(Human-Induced Obstructions has been replaced by Part XII of Volume 2.)

~~Human-Induced Obstructions~~

~~Human-caused obstructions include such structures as dams, sills, and improperly installed culverts. The most obvious solution to fish passage problems, for example, culverts, is proper initial installation of the structure. An even better solution would be to install a bridge instead. Unfortunately numerous dams and improperly constructed structures exist. Various types of fishways can be built to provide access past dams and other barriers created by people.~~

Fishways

~~Fishways provide a way past obstructions that impede upstream migration of salmonids. The structures generally consist of a flume with baffles or a series of stepped pools that slow the water to a velocity more easily negotiated by fish. The three types of fishways to be discussed are: 1) the step-and-pool; 2) Denil ladders; and 3) the Alaskan steep-pass. All fishways require regular maintenance, and should be installed only when absolutely necessary.~~

~~Successful design, construction and operation of a fishway requires close cooperation between designers and biologists. Fishways should be designed to pass fish during at least 90 percent of the flow conditions that will be encountered. Downstream migrant smolts need a minimum 6 inches depth of water. Elements that effect fish passage include height of the jump, velocity of the water, and amount of space the fish has for maneuvering. There are six principal items of biological and hydrological information required prior to the design of a fishway:~~

- ~~• Species of salmonids in the river system, as well as magnitude and timing of the runs;~~
- ~~• Probable access route to the barrier, including areas where fish will congregate below the obstruction;~~
- ~~• Extent of spawning and nursery areas and potential salmonid production from both above and below the obstruction;~~

CALIFORNIA SALMONID STREAM HABITAT RESTORATION MANUAL

- Type and quantity of anticipated transportable debris;
- Frequency, duration, timing, and magnitude of anticipated flows, especially extreme high and low flows;
- Location of other barriers in the stream system, and their possible effects on distribution of salmonids.

After preliminary information is analyzed, these items must be considered to locate and design the final structure.

- The entrance to a Denil ladder and Alaskan steep pass fishways should be as close as possible to the foot of the obstruction, with the fishway extended into the pool so a swim-in condition exists at all operational flows;
- Flows in and near the fishway entrance should be sufficient to attract fish at all water levels;
- When fish must swim through high velocity water, changes in direction should be minimized;
- Energy dissipation should be complete in a step and pool fishway, with no carryover from pool to pool;
- Fishways must be deep enough for the largest known fish in the system;
- Resting areas must be adequate;
- Flow patterns in the fishway must be stable, with no water surges;
- A debris deflector should be incorporated at the flow intake;
- The upstream exit must allow fish to easily reach secure resting habitat;
- Need for cleaning, regulating and repairing the fishway should be minimal.

Step and Pool Fishway

A step and pool fishway consists of a series of vertical partitions spaced down the length of a specially constructed channel or flume (Figure VII-39). Flow spills over the crests of the partitions, each slightly lower than the one above, creating a series of step-like pools which fish can ascend with ease. In streams where there is substantial movement of bedload, tops of concrete walls are capped with 1/4 inch steel angle or plate to provide greater durability. Pools must be carefully sized to dissipate the energy of the cascading flow. Standard specifications for a step and pool ladder require pools 8 feet long, 6 feet wide, and 4 feet deep, with no more than 12 inches of rise between steps. Step and pool fishways are most effective where water levels remain fairly constant. Depth of water cresting weir sills is critical, particularly in relation to pool size. Crest should not exceed 15 inches in depth or associated water velocities will likely impede

CALIFORNIA SALMONID STREAM HABITAT RESTORATION MANUAL

fish passage. In situations where water levels fluctuate, these fishways require regular adjustment at an upstream control to provide optimum depth and velocity for fish passage.

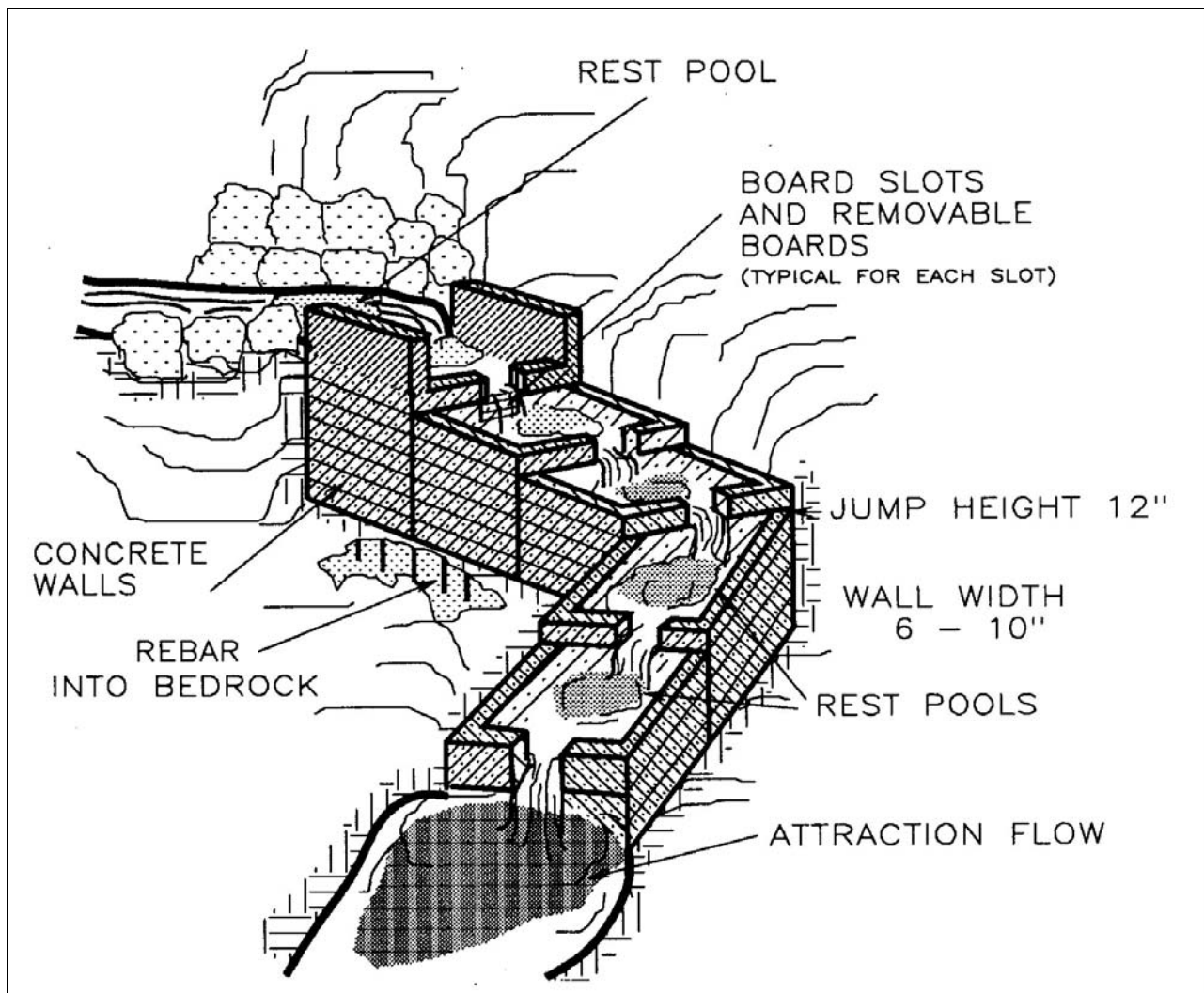

Figure VII-39. Step-and-pool fishway.

CALIFORNIA SALMONID STREAM HABITAT RESTORATION MANUAL

Denil Fishway

The Denil fishway is essentially a short section of flume with baffles affixed to the sidewalls and floor (Figure VII-40). The energy of water passing through the structures is dissipated in turbulence caused by baffles, which leave a narrow zone of low-velocity flow. The Denil fishway in most instances can be installed at steeper slopes than the step-and-pool, and for a given height of obstruction, can be substantially shorter. They are very efficient at passing bedload materials which would block other types of fishways. However, baffles can easily catch floating debris, resulting in partial or complete blockage to fish passage. They require daily maintenance during fish migration season to ensure clear passage.

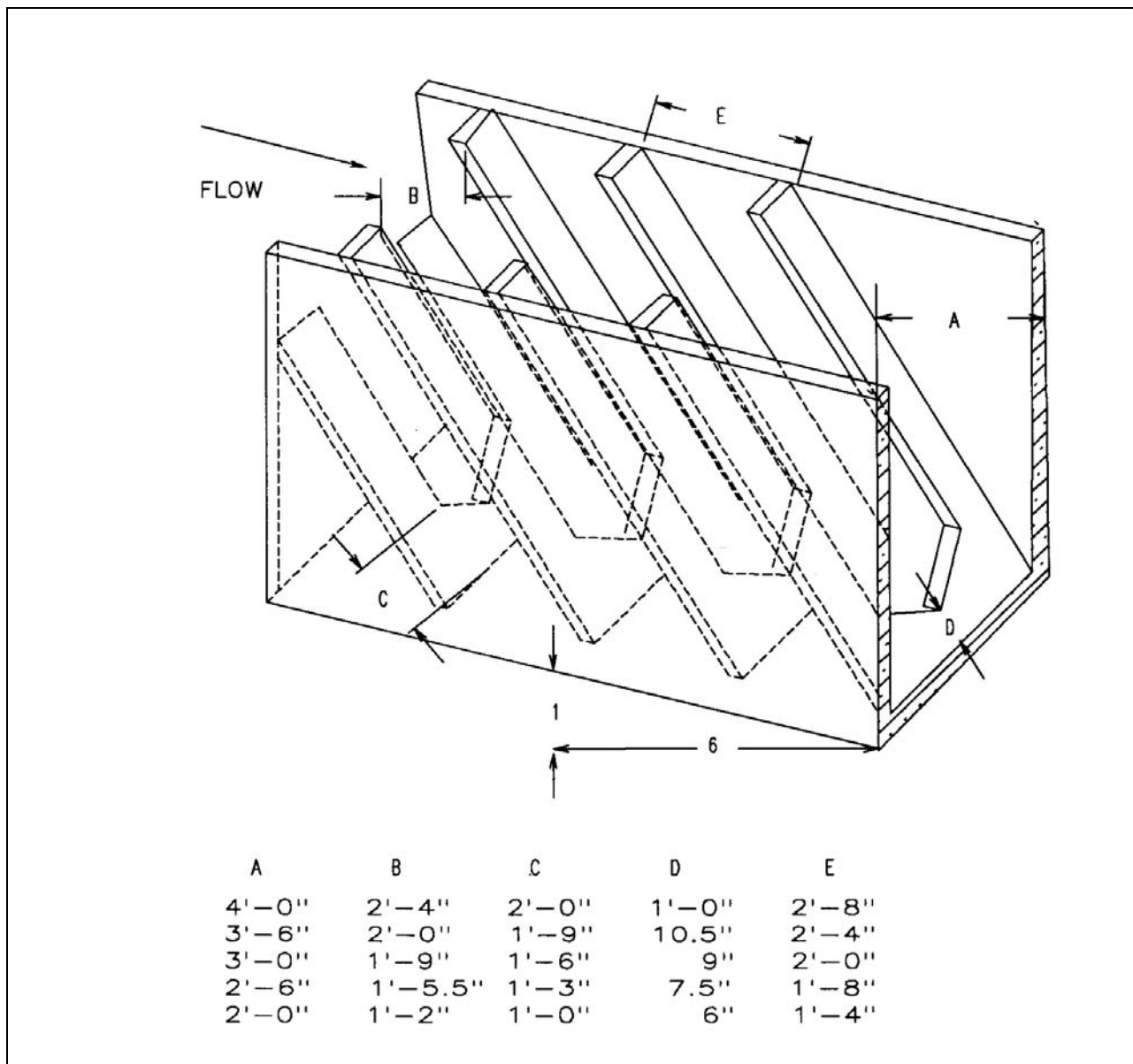

Figure VII-40. Denil fishway.

CALIFORNIA SALMONID STREAM HABITAT RESTORATION MANUAL

Alaskan Steep-pass

A modification of the Denil fishway, the Alaskan steep pass, is smaller, reduces velocities more effectively, can be prefabricated from lightweight aluminum, and is easily installed (Figure VII-41). However, it is more likely to plug with debris.

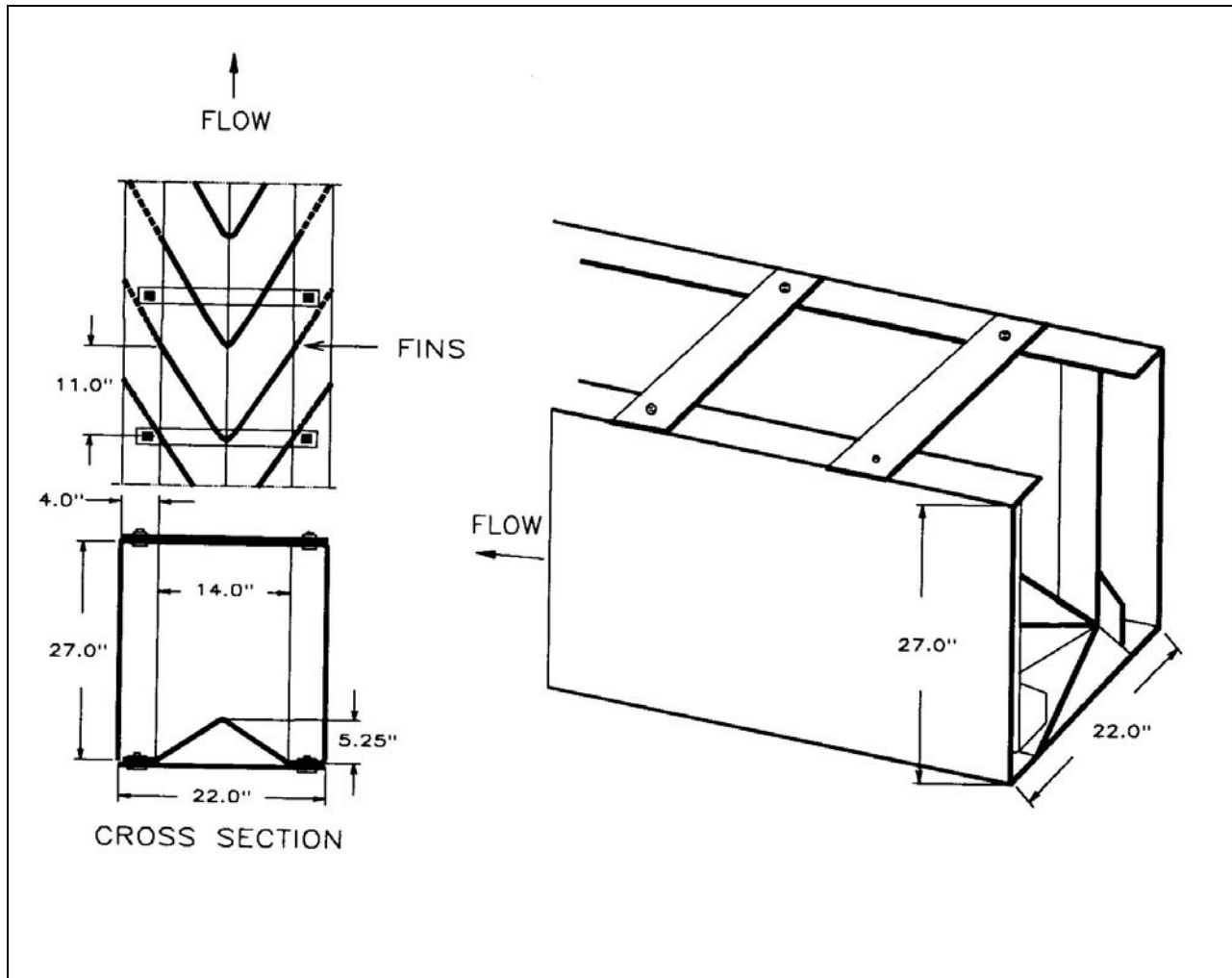

Figure VII-41. Alaskan steep-pass.

Placement of a fishway entrance is critical. The fishway entrance should be positioned where fish tend to congregate, normally in the area of greatest flow at the base of the obstruction. The bottom of the fishway must extend into the pool to provide a swim-in situation for the fish. Sometimes a rock wall, a training wall, or even a barrier dam, is needed to divert water and fish toward the fishway entrance. The Alaskan steep pass has shown poor results in passing large salmon in California and is not recommended for that purpose. They have, however, proved efficient in passing steelhead.

CALIFORNIA SALMONID STREAM HABITAT RESTORATION MANUAL

Culverts

Properly installed culverts should pass fish during at least 90 percent of all anticipated flows. Migration barriers are frequently created by velocity chutes within culverts and jump barriers created by scour at the downstream end of culverts. Such barriers affect not only migrating adults, but they invariably prevent upstream juvenile movement during the low flows typical of summer rearing periods.

Back-Flooding Weirs

If the culvert is not installed with at least one-quarter of its diameter at or below the stream grade, the erosive hydraulic action of the discharged water will cut away the stream bed below the culvert outlet and create a waterfall. If this condition occurs, it can often be corrected by installing back-flooding weirs (Figure VII-42).

These weirs can be constructed of either logs or boulders. Ideally, the weir directly below the culvert should be of sufficient height to back-flood the culvert to a depth of 12 inches. Starting at the weir immediately below the culvert and proceeding downstream, each subsequent weir elevation should be no greater than a 12-inch drop (see section on boulder and log weirs).

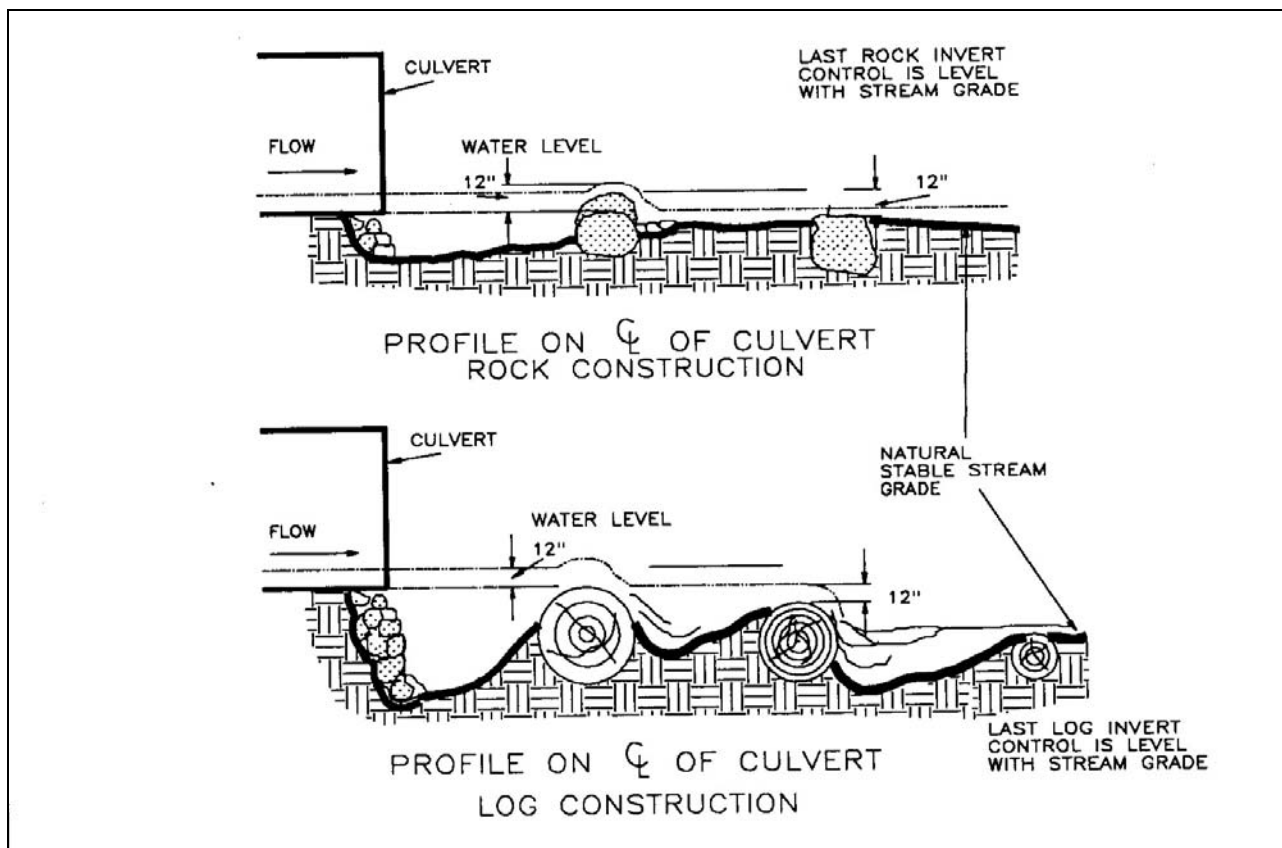

Figure VII-42. Back-flooding weirs.

CALIFORNIA SALMONID STREAM HABITAT RESTORATION MANUAL

Culvert Baffles

Culverts lack the natural roughness elements found in stream beds. Therefore, culverts often must be fitted with baffles to allow upstream fish migration. Installation of baffles in a culvert reduces the capacity of the culvert to pass water. It is important to calculate the discharge for the drainage area above the culvert to determine if the culvert will accommodate the expected discharge with baffles installed. The agency or landowner responsible for the culvert must be notified and be in agreement with the project before the baffle installation is begun. Two types of baffles are common in California: the Washington baffle, and the steel ramp corrugated metal pipe baffle.

Washington Baffles

Washington baffles are designed to reduce velocities and increase water depths in concrete box culverts. These baffles should be constructed from either redwood or steel. In culverts exceeding 7 feet in width, a separator wall, two times the height of the baffles, should be installed to improve operating performance over a broad range of flows (Figure VII-43). To make the majority of flow go through the baffles during low flows, a flow barrier wall, half the height of the separator wall, should be constructed between the separator wall and the culvert wall. This will provide for low flow passage of smolts and fry.

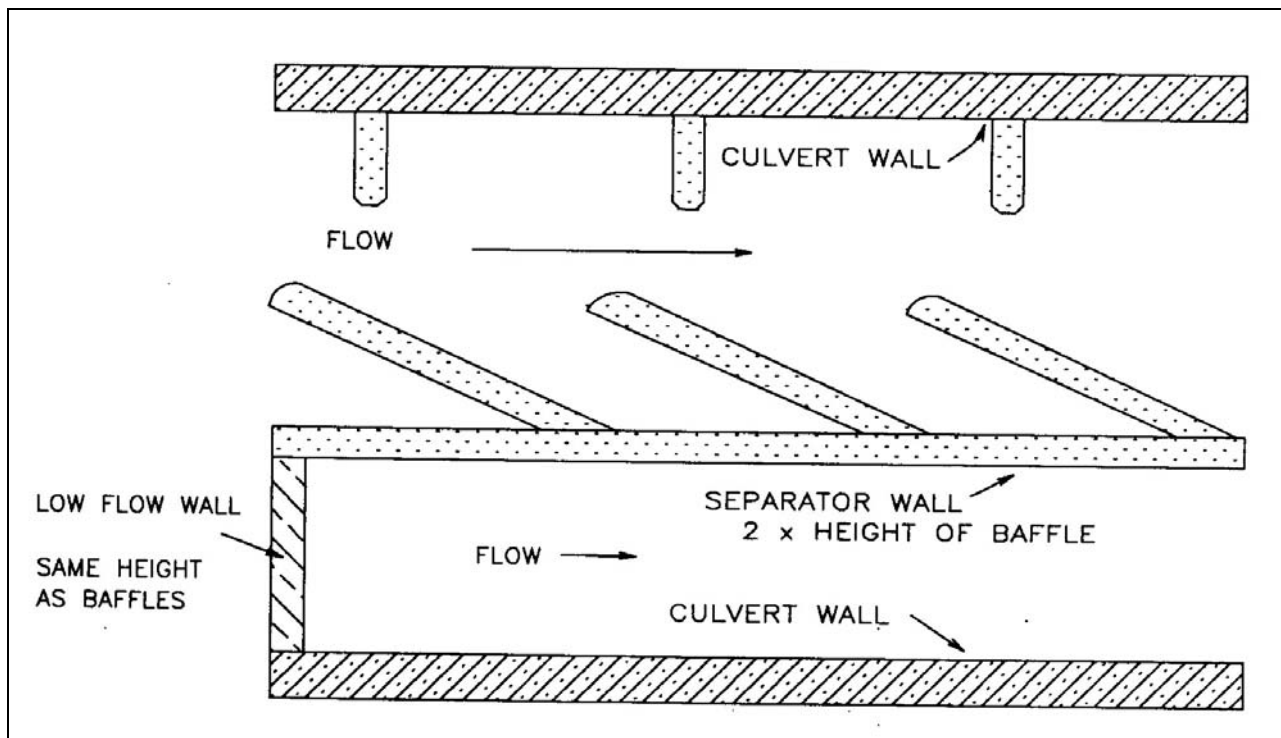

Figure VII-43. Washington baffles with a separator wall. (*Stream Enhancement Guide*, British Columbia Ministry of Environment, 1980, p. 42).

CALIFORNIA SALMONID STREAM HABITAT RESTORATION MANUAL

Baffles are installed with all long baffles on one side of the culvert, and all short baffles on the opposite side. Size of the baffle is determined relative to size of culvert. In box culverts less than 7 feet wide, length of the long baffle is 95 percent of the culvert width, and the length of the short baffle is 38 percent of the width of the culvert. The long baffle is oriented upstream 30 degrees from the culvert wall, and the short baffle is oriented 90 degrees from the culvert wall. Short baffles are positioned 26 percent of culvert width downstream from the leading edges of long baffles, facing the middle of the culvert. The first and last baffles in the culvert are spaced away from the ends a distance that equals 50 percent of the diameter of the culvert (Figure VII-44). Washington baffles must be placed in the thalweg. If the culvert is level, a low flow training wall is needed at the head of the culvert to divert flows into the Washington baffles.

Redwood baffles are constructed from 6 inch by 6 inch redwood beams. This allows baffles to be installed easily in culverts with rough or cobbled bottoms because they can be cut to fit. Redwood baffles are secured to the culvert bottom with at least two 3/4 inch diameter, 18-inch long threaded rods. Drill 7/8 inch holes, 6 inches deep in the culvert bottom, spaced 12 inches in from ends of the baffles. Secure threaded rods in holes with polyester resin adhesive. Drill holes in two 6 inch by 6 inch beams to match the spacing of the rods, forming a baffle 12 inches high. The upper beam must have a countersink hole drilled in the top side to allow recessing the washer and nut on the anchor bolt (Figure VII-45).

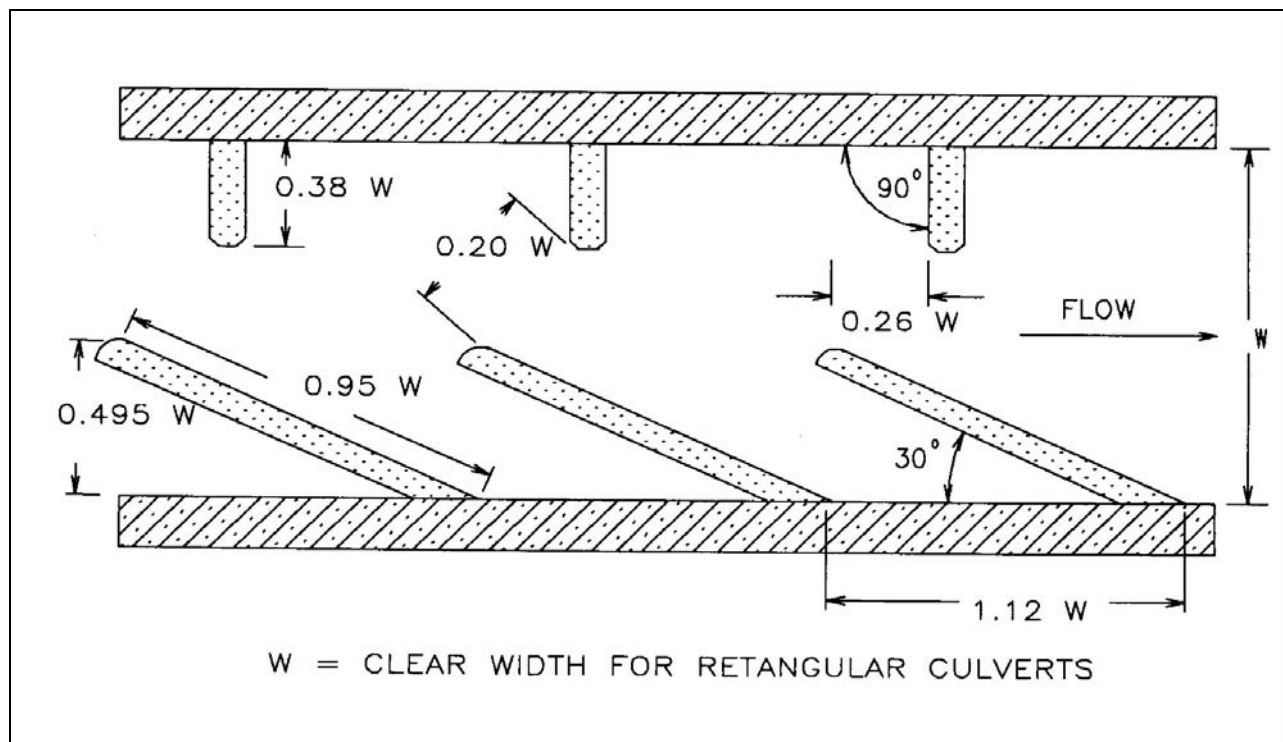

Figure VII-44. Washington baffles. (*Stream Enhancement Guide*, British Columbia Ministry of Environment, 1980, p.42).

CALIFORNIA SALMONID STREAM HABITAT RESTORATION MANUAL

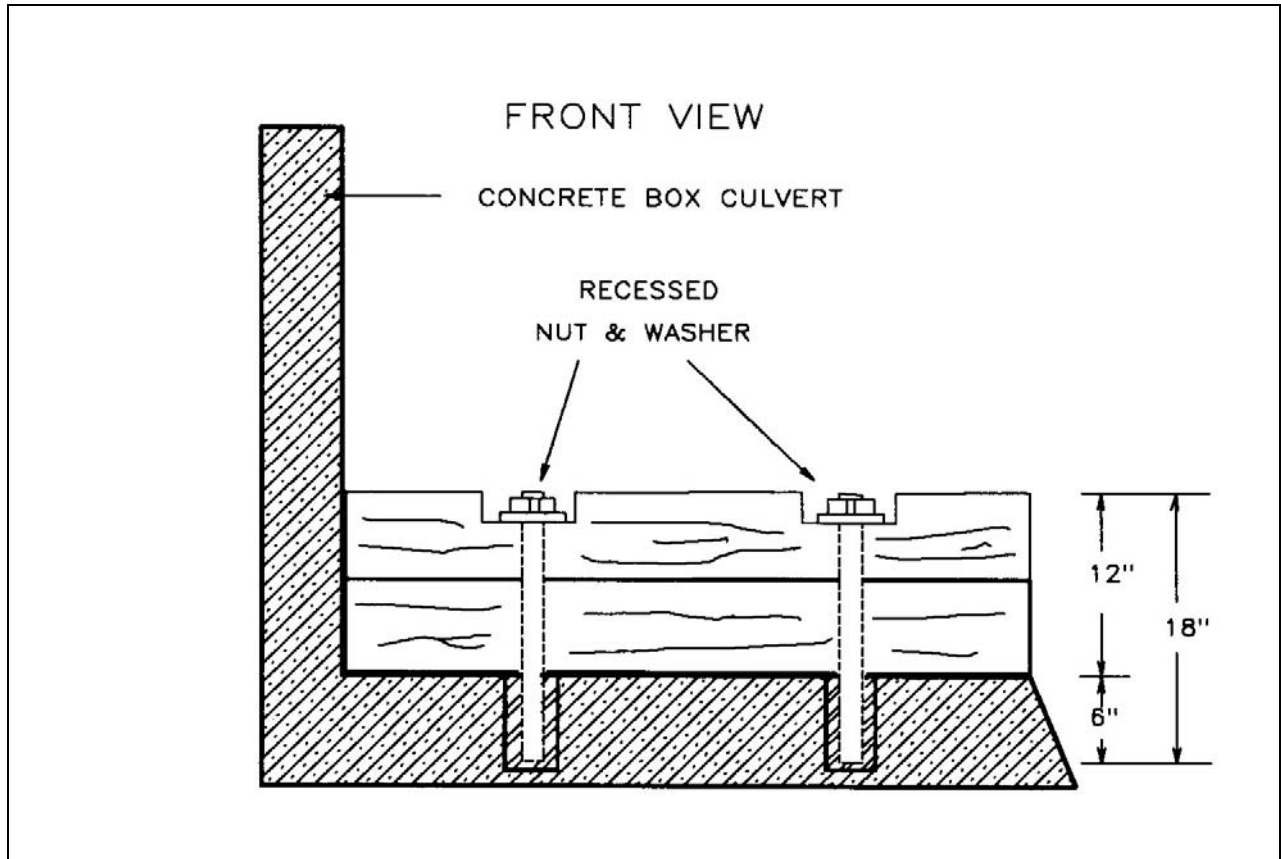

Figure VII-45. Redwood Washington baffle construction.

Steel Washington baffles are more resistant to bedload abrasion than wooden baffles (Figure VII-46). Steel Washington baffles are installed in the same manner as redwood Washington baffles with the following exceptions. Baffles are secured to the culvert bottom with 2-inch square mounting tabs, welded front and back. Each tab is drilled with a 3/4-inch bolt hole. Long baffles have four and short baffles have three tabs on each side. Drill 7/8-inch holes in the floor of the concrete culvert 6 inches deep to match the hole pattern on the baffles. Secure 7-inch X 3/4-inch threaded rods into the holes with polyester resin adhesive. Place the baffles over the rods and secure them with washers and nuts. The baffles may also be installed using expansion bolts.

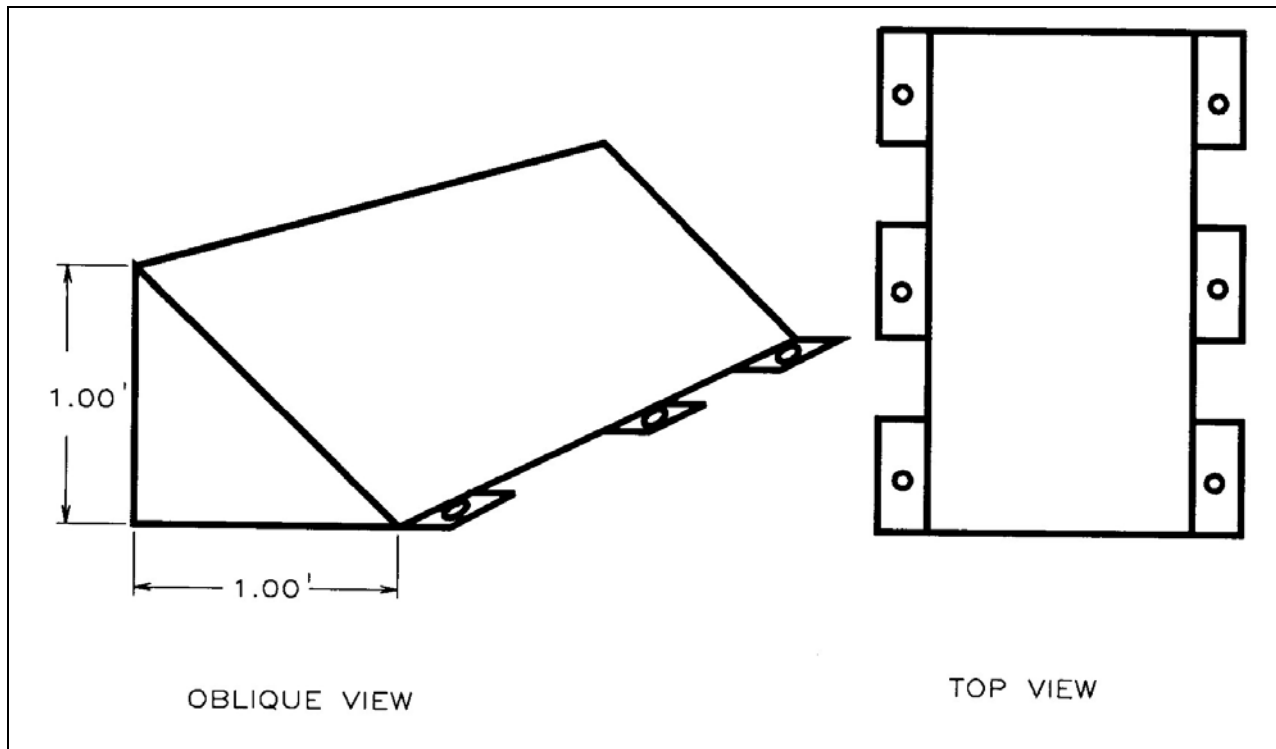

Figure VII-46. Steel Washington baffle.

Corrugated Metal Pipe (CMP) Steel Ramp Baffles

CMP steel ramp baffles are used in corrugated metal pipe where Washington baffles are difficult to install because of the curvature of the culvert. The narrow width of steel ramp baffles allows them to be installed easily on the curved bottom of CMP culverts without leaving a gap under the baffle. Baffles should be attached to CMP culverts by welding, or with "L" bolts if the bottom of the culvert is in good condition (Figure VII-47).

Steel ramp baffles are installed alternating from side to side along the center line of the culvert bottom, with the ramp face of the baffle oriented upstream. They are spaced apart a distance equal to approximately 90 to 95 percent of the culvert diameter. Minimum thickness of the baffle material should be 1/4 inch steel plate. Baffles can be constructed to fit varying sizes of culverts. In culverts 6 feet in diameter and larger, 24-inch wide baffles are used. In culverts 4 feet in diameter, 16-inch wide baffles are used. In culverts 3 feet in diameter, 12-inch wide baffles are used. All baffles have 12-inch high faces.

If baffles are bolted into the culvert, weld two tabs perpendicular to the bottom edge of the baffle's vertical side. Drill 3/4 inch holes in the leading edge of the baffle and in the tabs. The distance between the front and back holes must be matched to the distance between convex ridges in the corrugated pipe where the 3/4 inch "L" bolts are to be secured. Mark and drill the holes in the culvert bottom using the baffle as a template.

CALIFORNIA SALMONID STREAM HABITAT RESTORATION MANUAL

The "L" end of the anchor bolts are placed in the holes drilled in the culvert bottom. Baffle is then placed over the anchor bolts and secured with washers and nuts.

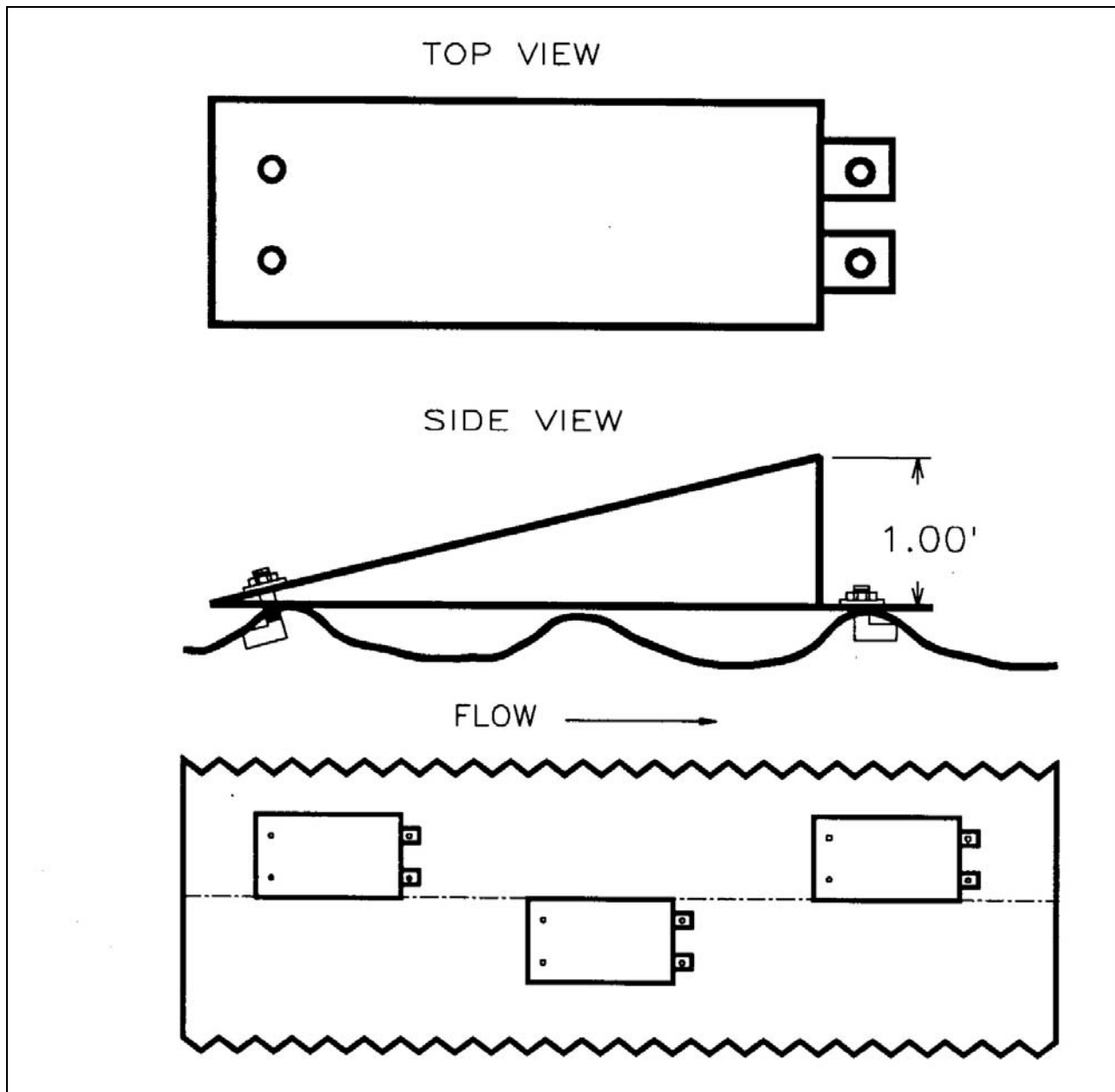

Figure VII-47. Corrugated metal pipe steel ramp baffles.

CALIFORNIA SALMONID STREAM HABITAT RESTORATION MANUAL

WATERSHED AND STREAM BANK STABILITY

Many streams are seriously affected by sediment from watershed and stream bank erosion. In all watersheds, erosion occurs in major storms. Other events occasionally occur which result in massive slope failure along a stream. These failures often introduce large amounts of fine sediment. However, they may also be a vital source of gravel, cobble, boulders, and large woody debris. Effects of each slope failure must be evaluated accordingly. Fine sediment may have a negative effect on fish habitat by covering spawning gravel, filling in pools, and creating high turbidity levels, which may cause gill abrasion, disease, stress, and egg or fish mortality. In some cases, these problems might be relatively short-term, especially when balanced against habitat benefits created by introduction of large, stable, structural elements.

When assessing erosion in watersheds, massive slope failures usually draw a great deal of attention but there are many other erosion sources that contribute fine sediment to streams. These are usually more easily treated than massive slope failure. This section will focus on: 1) landslide stabilization; 2) stream bank stabilization; 3) upslope erosion control with mulching; 4) revegetation in the riparian zone and upslope; 5) checkdam construction to control gully erosion; 6) waterbar construction to control erosion from dirt and gravel roads; and 7) exclusionary livestock fencing.

Slide Stabilization

Slide stabilization requires use of one or more complementary methods to control the slide toe, protect the slope surface, and treat the head and seat of the mobilized area of the slope. Mass slope failure can take many forms. These include slumps, rotational movements of "blocks" of soil, soil or mud flows, debris torrents, and slope creep. Slides are areas where the surface layer of soil and its accompanying vegetation move downhill under the influence of gravity. Slides are usually triggered by undercutting, or some force like heavy rain or earth tremors. Excess water that adds weight or liquidity to the slope may accumulate due to a heavy rainfall or snow melt, vegetation removal, or disruption of the natural drainage pattern.

Sometimes, dried out soil can result in a slide because the bonding of water molecules provided by moderate soil moisture is lost. This can happen if vegetation has been removed and the slope has lost its shade cover and the binding properties of roots.

The cause of a mass slope failure must be determined before an appropriate treatment can be prescribed. This may require an air photo analysis (historical sequence), geological and topographic map review, hydrological investigation, and field surveys to verify map and photo analysis (Part II). Once background information has been obtained and verified by field surveys, decisions on treatments can be made.

CALIFORNIA SALMONID STREAM HABITAT RESTORATION MANUAL

Slide stabilization is employed only where it is determined to be beneficial and feasible in reducing the amount of fine sediments entering the stream. Slides may best be stabilized and sediment input to streams reduced by a combination of toe protection, upslope drainage correction, and revegetation techniques.

Stream Bank Stabilization

Stream bank erosion is a natural process that can be beneficial by providing a source of boulders, cobble and gravel for fish habitat. However, when natural levels of erosion are exceeded, fish habitat balance may be lost and the stream and riparian zone may have difficulty recovering. In these situations, it is desirable to stabilize eroding stream banks. This can be accomplished with boulder and log structures, revegetation, and removal or relocation of obstructions that are deflecting flow into unstable banks. If there are relatively few isolated bank erosion problems, it is probably feasible to armor the eroding banks. However, when there are numerous landslides and bank failures along a channel, it may not be cost effective to undertake spot treatment. If the basic destabilizing process in a watershed, such as altered runoff rates, can not be controlled, treatment may not have a reasonable chance of success.

In some situations, stabilization of eroding banks may be detrimental to fish habitat. For example, on some levees built for flood or erosion control, development of riparian vegetation is prevented by manual or chemical means. In fisheries applications, bank stabilization must address the objective of improving fish habitat.

Access to an erosion site and availability of materials will partially determine the stabilization procedure, while stream hydrology and channel type will dictate the structure used. Hydraulic cross-sectional analysis will disclose stream dimensions required to assure passage of bankfull flows.

Boulder Stream Bank Stabilization Structures

Boulder structures are the preferred method for stabilizing stream banks because of their longevity and resistance to movement. Boulders can be used to riprap stream banks or construct wing-deflectors to deflect flow away from an unstable bank.

Boulder Riprap

Boulder riprap is a method for armoring stream banks with large boulders for preventing bank erosion. Riprap footing is laid in a "toe" trench dug along the base of the unstable bank. Boulder riprap is then laid on the bank slope up to the bankfull discharge level. Large angular boulders are best suited for this purpose. The exact size of boulder will vary with size of the channel and the stream. Revegetation with native species, including coniferous and deciduous trees, shrubs, and ground cover should be included as part of the treatment.

CALIFORNIA SALMONID STREAM HABITAT RESTORATION MANUAL

Boulder riprap can provide toe protection to a slide or other stream bank instability. It can be very useful for protecting banks in areas where log or boulder instream structures added to the stream could lead to stream bank erosion.

The type of boulder selected will be a major determinant of stability and longevity of the riprap. If boulders are imported, large, dense, angular boulders are preferable. It is important that only structurally competent boulders be used. Some kinds of boulders will break down rapidly and should be avoided, such as sandstone or some other types of sedimentary rock, which are poorly bonded and deteriorate rapidly.

The toe trench must be excavated to sufficient depth to prevent the structure from becoming undermined. If there is equipment access, this can be most effectively accomplished with a backhoe or excavator. Excavators work well on large streams that require relatively large rock. In smaller systems a backhoe can perform equally as well, is much faster to move, has the advantage of a front-end loading bucket, and is less expensive. Regardless of the machine in use, the key is to have an experienced, competent operator who is sensitive to the stream environment.

An excavator or backhoe can also be used to place boulders. Many machines have a bucket equipped with a thumb which makes it possible for them to grab boulders. These machines are ideal for setting riprap boulders. A front-end loader or bulldozer working in conjunction with a backhoe or excavator can greatly facilitate the construction process.

A toe trench that provides solid footing for riprap layers is necessary to prevent stream flow from undermining the riprap and causing it to collapse into the channel. Collapsed riprap could cause even more severe bank erosion. Riprap should not be attempted in streams with degrading streambeds. As the streambed degrades, riprap will be undercut and fail.

The largest boulders are placed in the toe trench to create the footing. They are placed tightly against each other. The next layer of boulders is placed so that it tapers back slightly from the base layer toward the near stream bank. The most stable riprap slope construction is achieved when each boulder has contact with at least three others, (three point contact). It first may be necessary to contour the bank above the channel, especially if it is vertical or nearly vertical. Slope should be no more than 1:1 or 45 degrees (the lower the angle of slope, the more stable it will be). Ideally, the finished angle of the riprap will be 2:1. The biggest boulders should be used in the lower layers and the smaller ones placed in the upper layers (Figure VII-48). Riprap should extend to above bankfull discharge. Riprap should also extend a little upstream and downstream from the treatment site to assure that the stream does not erode at the edges of the riprap. Riprap will resist erosion and may accelerate stream flow, creating a new erosion hazard downstream. It is essential that the banks at the end of the riprap are stable and resistant to erosion and that precautions are taken to avoid downstream damage.

CALIFORNIA SALMONID STREAM HABITAT RESTORATION MANUAL

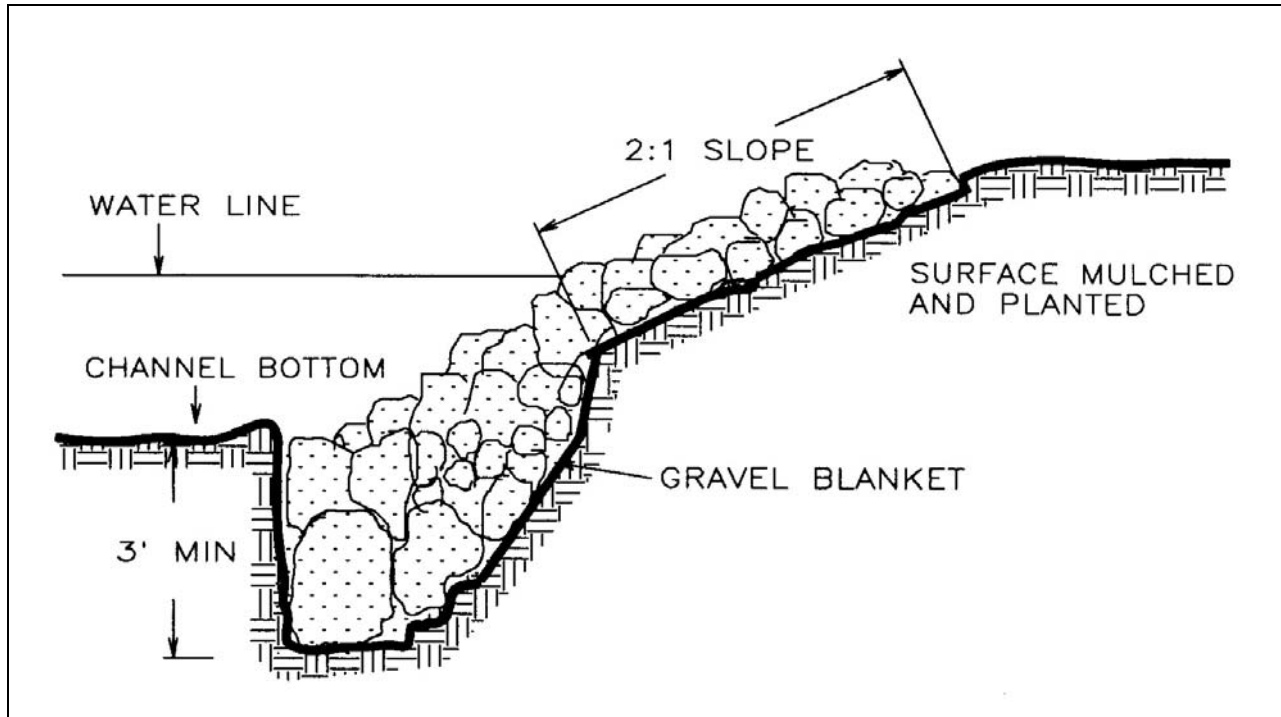

Figure VII-48. Riprap.

A gravel blanket or geotextile fabric should be used under riprap. In general, geotextile fabric is used on slopes which are $3/4$ to 1 or less, simply because gravel will not stay on these slopes. A gravel blanket that is one foot thick should be used on slopes of 1:1 or greater. The purpose of the gravel blanket or geotextile fabric is to prevent soil underlying the placed riprap boulders from washing out and possibly causing the riprap to slump and fail. Use of geotextile fabric inhibits establishment and natural spread of plants on treated sites. Woody cuttings can be punched down through geotextile fabric, but other plants cannot push roots down through the material. Never install geotextile fabric where a gravel blanket can be used effectively.

It may be necessary to chink riprap interstices with small rock if bank material is particularly erosion prone. This protects underlying material from exposure to high-velocity flows.

CALIFORNIA SALMONID STREAM HABITAT RESTORATION MANUAL

Boulder Wing-Deflectors

Wing-deflectors used for bank stabilization are similar in construction to wing-deflectors used to create or enhance specific fish habitat features. In most cases, bank stabilization and habitat restoration benefits can be achieved. Wing-deflectors installed solely to provide bank stabilization may have a higher angle of intersection with the stream bank.

Wing-deflectors direct flow away from an unstable bank and provide armor (a hard point) to protect the toe of the slope from further erosion. Improper use of wing-deflectors can cause accelerated erosion on the opposing bank. Boulder faces in the deflector structures have the added benefit of providing invertebrate habitat, and space between boulders provides juvenile salmonid escape cover (Figure VII-49).

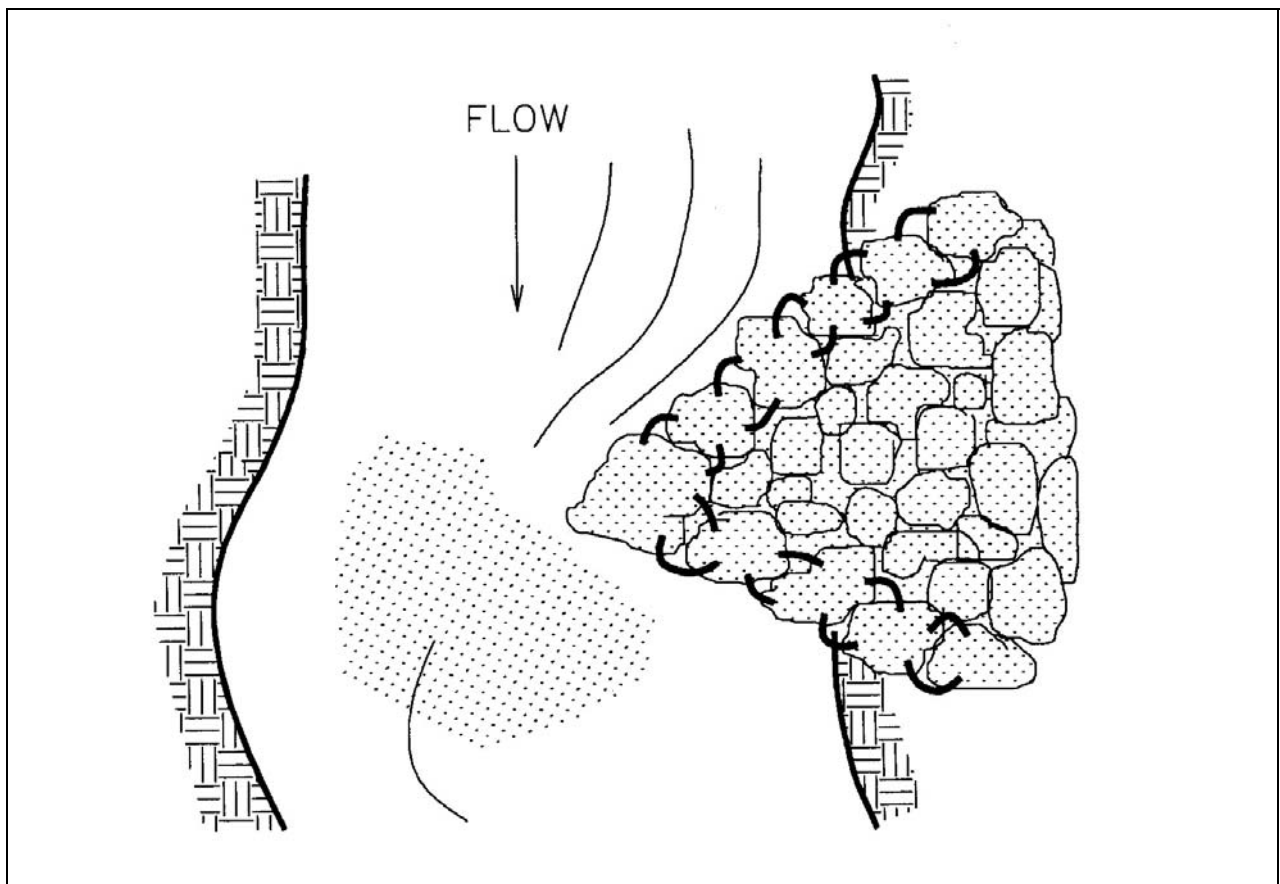

Figure VII-49. Boulder wing-deflector.

Depending on flow regime of the stream and size of the boulders used, it may be necessary to cable boulders together using polyester resin adhesive. The largest boulder(s) available is used for the apex of the deflector. The apex of the deflector is at the lowest elevation. The deflector should slope upwards to the bank. Rate of rise will be determined by bank conditions. This angle should be no more than 45 degrees. Additional layers of boulders may be placed on top of the base layer to reach the desired elevation and slope angle. If the substrate allows, a toe trench should be dug for the upstream and downstream legs of the deflector, and the structure must be keyed at least 4 to 6 feet into the stream bank.

CALIFORNIA SALMONID STREAM HABITAT RESTORATION MANUAL

The leading, or upstream edge of the deflector should be the longest side of the structure and should form an angle of approximately 30 degrees with the bank. The leading edge on the upstream side of the deflector should contain the largest available boulders. The downstream edge should be made with the remaining largest boulders. The interior of the triangle can be filled with smaller boulders. Depending on bank conditions upstream and downstream of the deflector, bank armor may be required adjacent to the wing-deflector.

Log Stream Bank Stabilization Structures

Log structures can be used where there is no access for heavy equipment, logs are available, and boulders are scarce. Log structures are generally not as durable as boulder structures. Banks can be further stabilized by planting vegetation, such as willows and cottonwoods, behind a log structure.

Cribbing

Cribbing construction is similar to building a log cabin. Logs are notched and cross logs are inserted between the layers and extended back into the bank. Cribbing protects the stream bank from high flows and holds soil in place (Figure VII-50).

Cribbing is used to reduce sediment input to a stream where bank erosion is a problem, logs are available, heavy equipment access is lacking or boulders are not available. Crib construction is labor intensive, but material costs are relatively low. If not available on site, suitable logs for cribbing must be located and delivered to the site. Logs should be selected for soundness, durability, uniformity of size, and ease of handling and delivery.

A base log(s) is placed in a toe trench below stream grade to prevent undercutting the structure. Base log(s) should be as long as can be manipulated while conforming to the contour of the stream bank. A good base log is necessary to insure stability and durability of the treatment.

Tieback logs are notched into the base log and placed at intervals along the base log (usually every 6 to 8 feet). Tieback logs are imbedded into the slope four to six feet, at grade with the base log. There should be at least two tiebacks per base log. Tiebacks are secured to the base log using threaded rebar. Approximately halfway up the backside of the base log, geotextile fabric is stapled every six inches, and placed to seal the bedding for the structure.

Once the first row of logs has had tiebacks and geotextile fabric installed, and has been back-filled to the top of the log, a second face log is placed on top of the tiebacks. This log is set back approximately 6 inches. The same procedure is repeated until desired height is reached. Stacked face-logs used in cribbing must be secured together using threaded rebar and/or cable. If cable is used to secure face logs together, the cable must be tightened using a fence stretcher or power pull. Finished height should reach the bankfull discharge level.

CALIFORNIA SALMONID STREAM HABITAT RESTORATION MANUAL

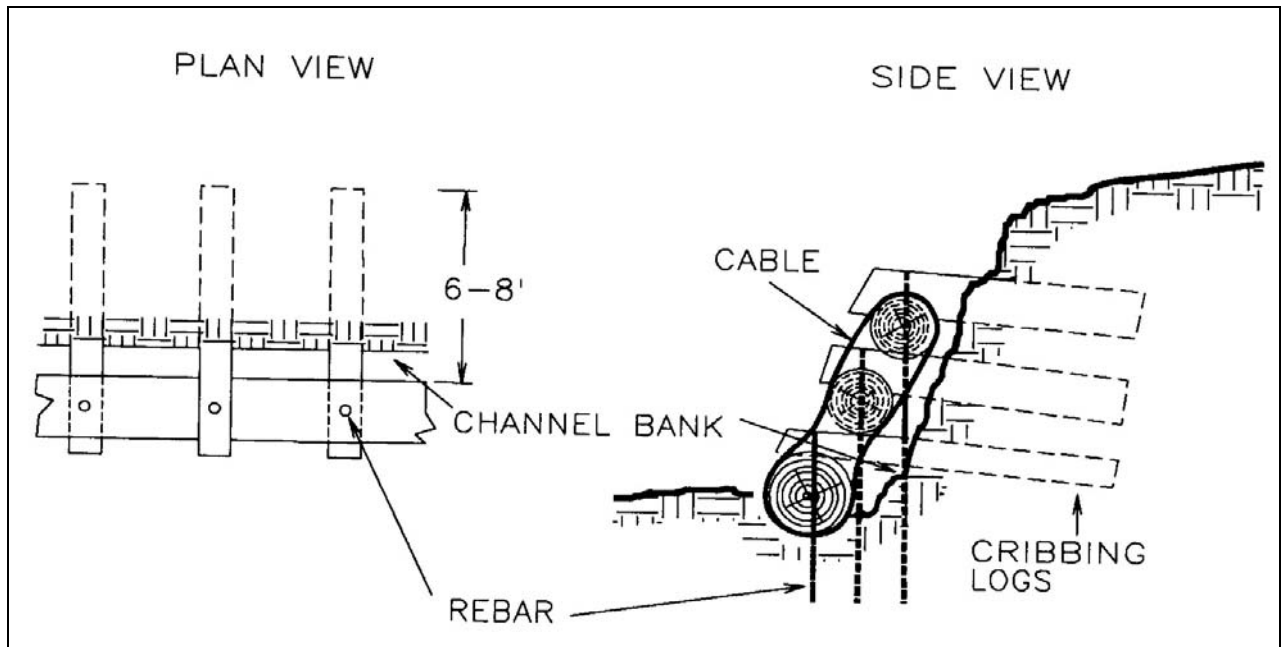

Figure VII-50. Log cribbing.

Live Vegetated Crib Wall

The basic construction of live vegetated crib walls on stream banks is the same as standard log crib walls. They may be built as either single or double walled structures. The double wall crib has far greater resistance to high flows (Figure VII-51). As each lift of the crib wall is installed, long cuttings of riparian plants are inserted on top of each fill layer. Willow can be used in combination with other fast rooting brush species such as native blackberry. The live willow cuttings function to replace crib logs as they decay over time. These riparian plants grow very rapidly and provide stream shade canopy and wildlife habitat during their first growing season.

- 1) As each lift is constructed, the face logs and tiebacks are filled with a mix of gravel and cobbles to the top of the face log. It is not necessary to use topsoil in the fill material, however, there should be enough fine grained materials to insure vegetation growth.
- 2) Live cuttings are laid in to form a complete cover layer. These live branches should have their butt ends into the soil behind the crib wall. The tips should stick out from the wall no more than one quarter of the cuttings total length.
- 3) The branches are then covered with a gravel/cobble mix to the top of the tiebacks.
- 4) Continue the next layer of the crib wall to the desired height.

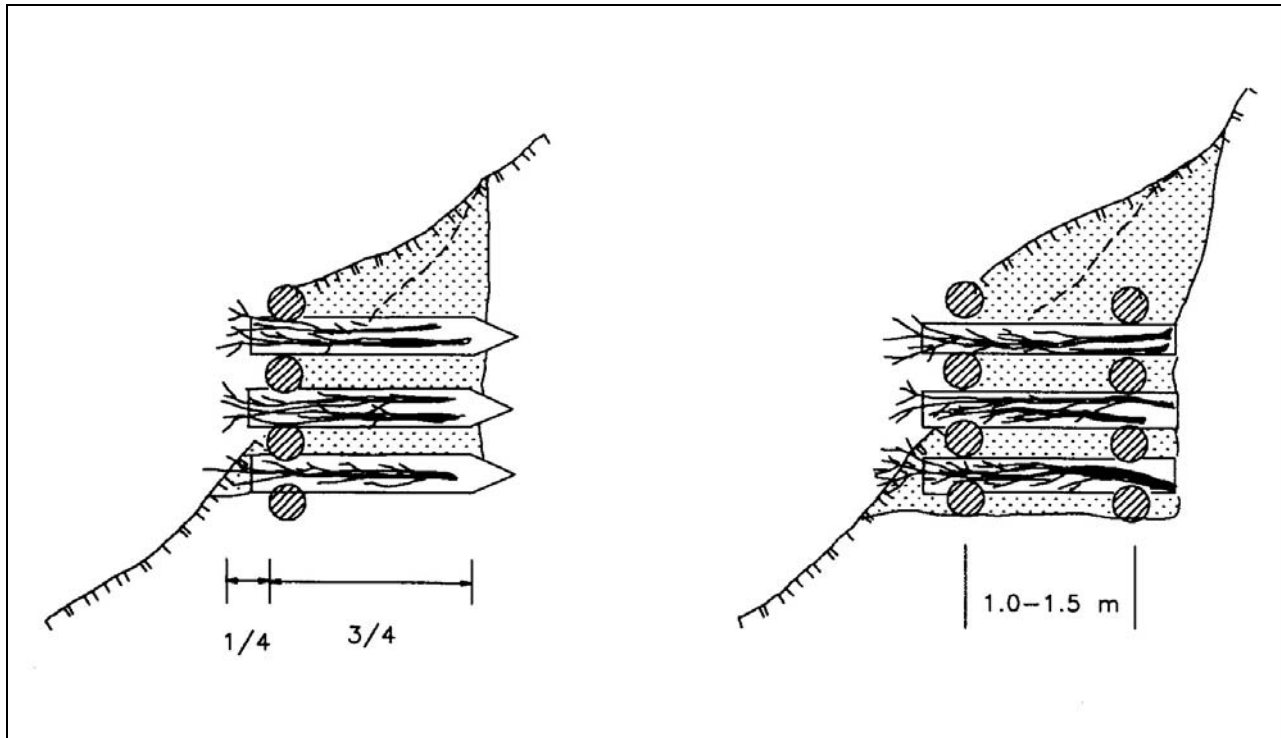

Figure VII-51. Live Vegetated Crib Wall (Schiechl and Stern, 1996)

Bank Armor

Log bank armoring is accomplished by stacking logs against the stream bank, parallel to the stream flow, to protect the bank against erosion. The log or logs are held in place by cabling them to boulders, heavyweight metal fence posts, culvert stakes, or a deadman (Figure VII-52).

By protecting the toe of unstable stream side slopes, erosion of fine sediment can be reduced and the stream bank can be stabilized. Logs can be used for stream bank armor in combination with other instream structures that require bank protection.

CALIFORNIA SALMONID STREAM HABITAT RESTORATION MANUAL

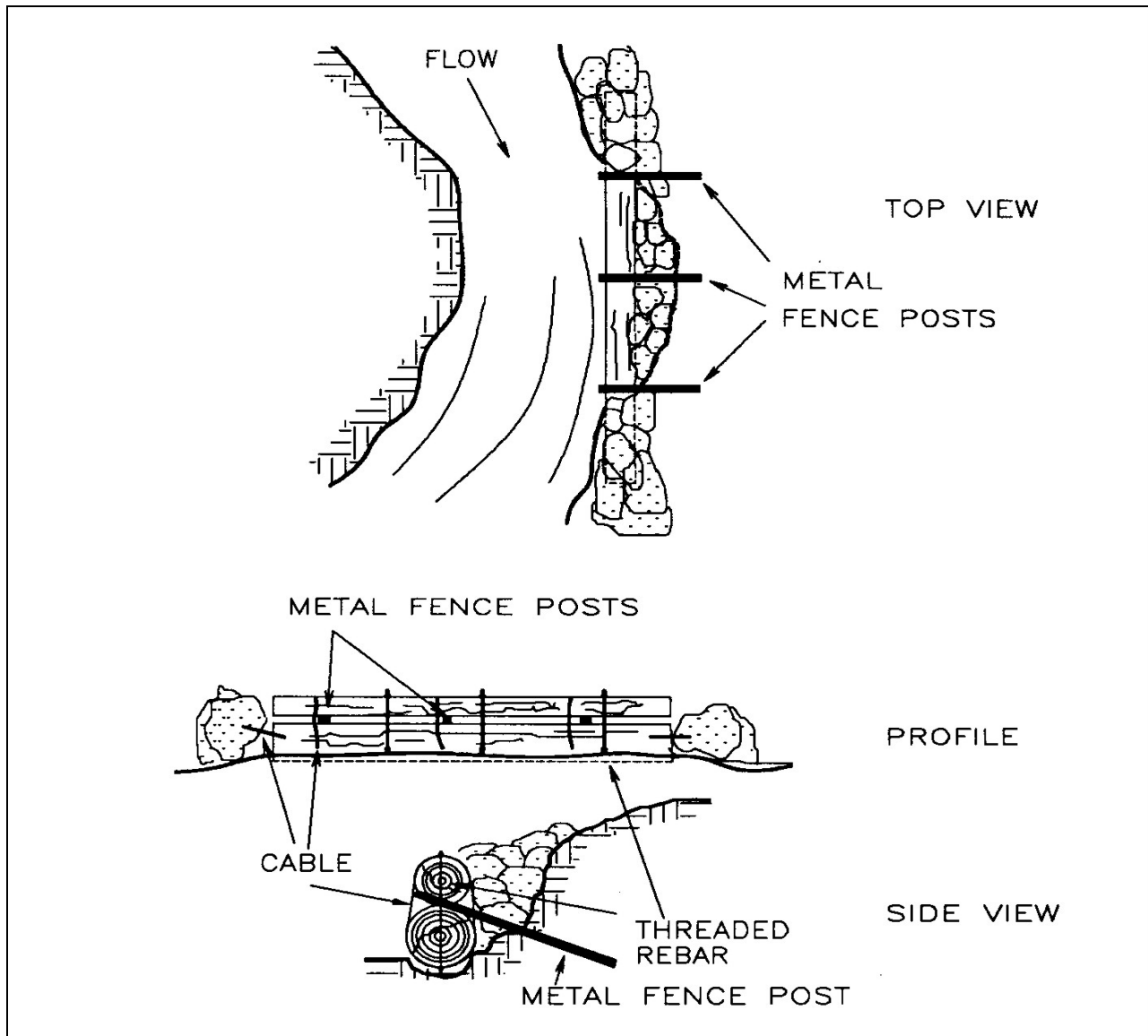

Figure VII-52. Log bank armor.

Bank armoring with logs requires excavation of a toe trench to accommodate a base log. The trench is dug along the base of the bank to be protected. Approximately one-third to one half of the base log should be buried in the trench.

Once the toe trench is excavated, the log can be placed. If the angle of the bank behind the log is steep, a second log can be placed above the base log. This log should rest partly on the base log and partly on the stream bank. Finished height of the bank armor should be the elevation of bankfull discharge. If bank armor is needed to protect an unstable stream bank, it may be necessary to install cribbing instead of armor.

Large boulders can be used to secure the ends of the logs. If boulders are not available, smaller rocks can be stacked on the log and cabled together. Cable should be run through a drilled hole in the log and into a hole in the boulder anchor. If boulder anchors cannot be acquired, heavyweight fence posts or culvert stakes can be used. Stakes are placed on both sides of the log

CALIFORNIA SALMONID STREAM HABITAT RESTORATION MANUAL

at about 6-foot intervals. Stake sets should be placed at both ends of each log. Spacing and length of stakes will vary depending on size of the log and magnitude of bankfull discharge. Stakes should be twice the length of log diameter and should be driven in so they do not protrude above the top of the log. With large diameter logs the force of buoyancy during high flow events will exert great pressure on stakes and the greater the number of stakes anchoring the log, the greater the chances of avoiding structure failure.

Cable can be attached to culvert stakes by drilling through the stake, running the cable through the hole, and clamping the cable back to itself. Flexible, small-diameter cable, from 3/8-inch to 1/2-inch should be used. When using regular metal fence stakes, drilling a hole large enough to pass the cable may not be possible. The cable must be looped tightly around the stake, using two wraps to make it secure, and clamped so that the loop will be held by the knobs of the fence stake. Fence stakes should be driven in at an angle over the top of the log (Figure VII-52). This will keep the cable from slipping over the top of the stake. Once the cable is securely attached, the stake should be driven in to tighten the cable over the top of the log.

Another way to hold the log in place is to use cable attached to a deadman placed in the bank. Unless a deadman is placed lower than the top of the uppermost log and secured with a tight length of cable, the log will be able to rise with the water level in high flows and may actually cause stream bank scour. In almost any situation, it is very difficult to prevent the log from floating during high flows if a deadman is the only anchoring system used. The deadman anchors should be placed at the same intervals as stakes, every 6 to 8 feet.

To add to stability of the log armor and to prevent fine sediment from eroding beneath it, staple geotextile fabric and fencing to the backside of the logs. Log structures should then be back-filled with cobble or boulders. As with any bank stabilization technique, woody vegetation should be planted behind finished log armor.

Log Wing-Deflectors

Log wing-deflectors are used to direct flow away from an unstable bank and hold soil on the bank. The deflector usually incorporates boulders to fill the interior of the triangle and to anchor the logs. The boulders add stability to the structure (Figure VII-53).

When used for stream bank stability, deflectors are almost always installed on the scoured bank only. Wing-deflectors may be installed in series. Wing-deflectors used for bank protection are the same general design as deflectors used for stream channel improvement. Site-specific alterations are made depending on size and extent of bank protection needed and the angle of bank slopes.

Wing-deflectors installed for stabilizing stream banks require placement of rock or other armor to a height above bankfull discharge level, to assure that the bank is adequately protected under high flow conditions. A series of wing-deflectors can be made to protect a length of stream bank beyond the length that can be protected by a single deflector.

**CALIFORNIA SALMONID STREAM
HABITAT RESTORATION MANUAL**

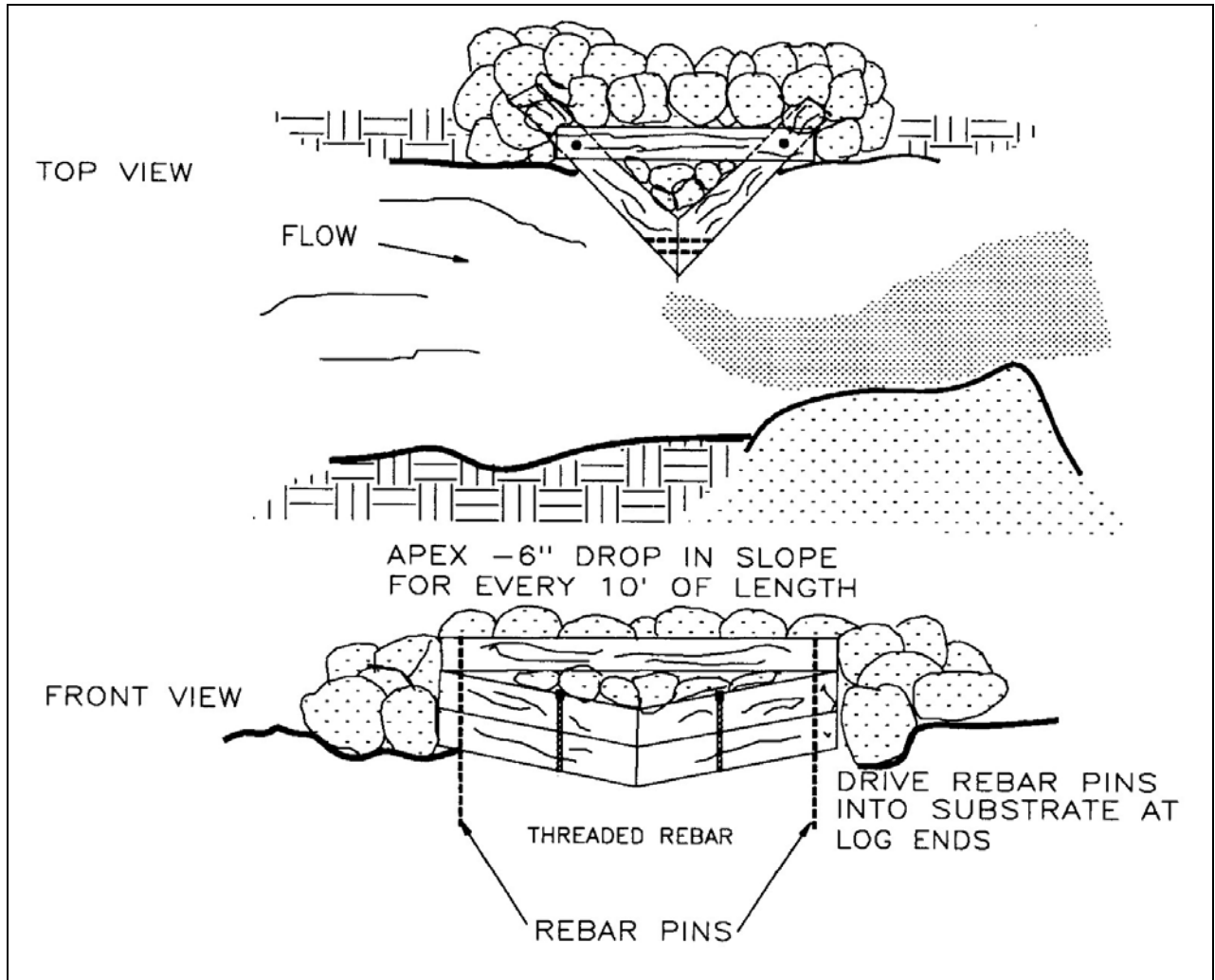

Figure VII-53. Log wing-deflector.

CALIFORNIA SALMONID STREAM HABITAT RESTORATION MANUAL

Tree Revetment

Tree revetment is used to stabilize vertical, eroding stream banks in low gradient meadow type streams. Trees are cut and laid against the vertical bank with tops angling downstream. Butts are tied off to the upper stream bank. Branches slow the water velocity and cause suspended sediment to settle, allowing bank building and revegetation to begin (Figure VII-54).

Cedar, Pacific yew, and juniper are preferred tree species, but almost any pre-commercial size conifer will suffice. Alders are not desirable due to their rapid decomposition. Care must be taken that water quality problems are not created in areas of low flow or standing water. Riparian vegetation generally should not be sacrificed for building material.

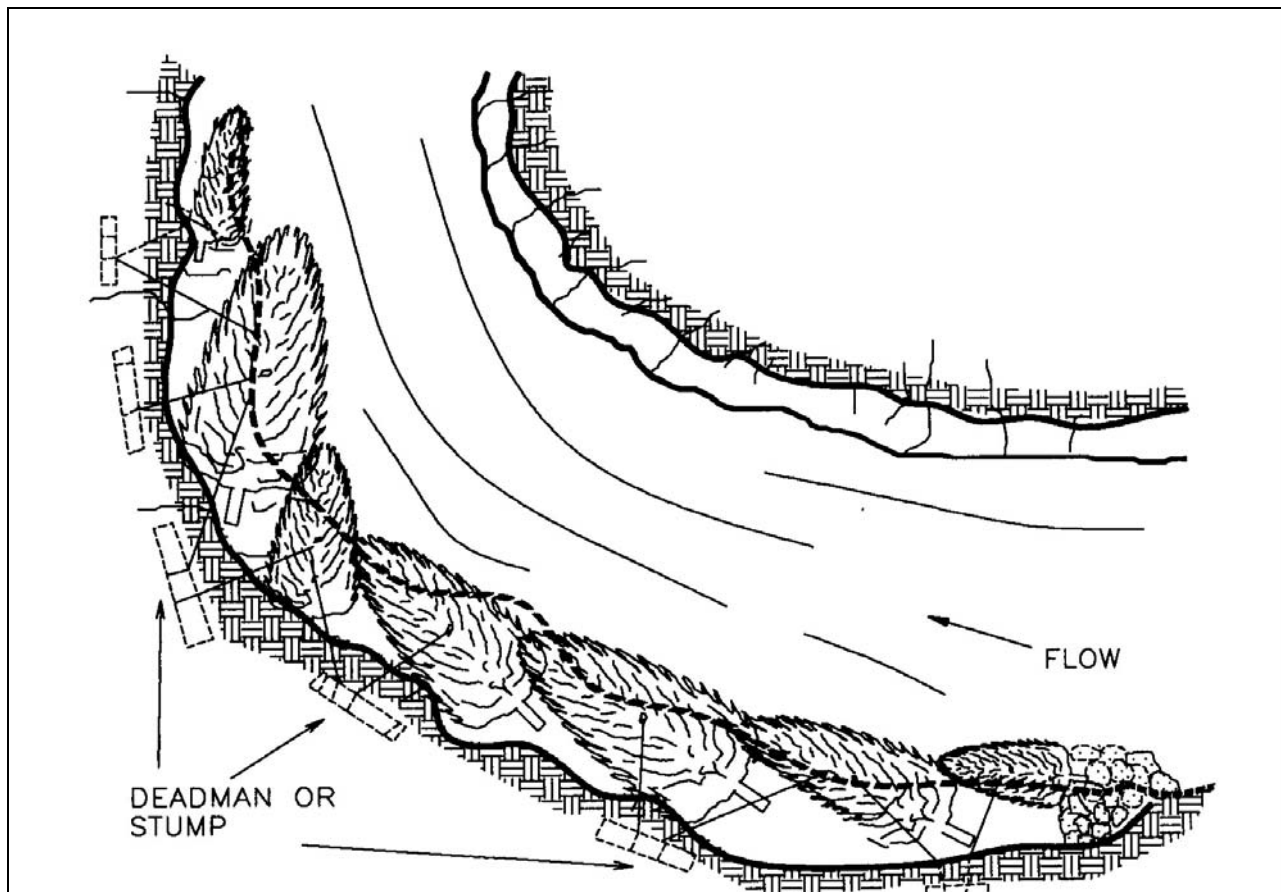

Figure VII-54. Tree revetment.

CALIFORNIA SALMONID STREAM HABITAT RESTORATION MANUAL

Native Material Revetment

Native material revetments are alternatives to boulder riprap armoring and crib wall type structures. By combining boulders, logs, and live plant material to armor a stream bank fish habitat is enhanced, in addition to creating a natural looking bank stabilization structure. Native material revetments can provide toe protection for slides or eroding banks and can also be used to re-establish natural stream channel dimensions (Figure VII-55).

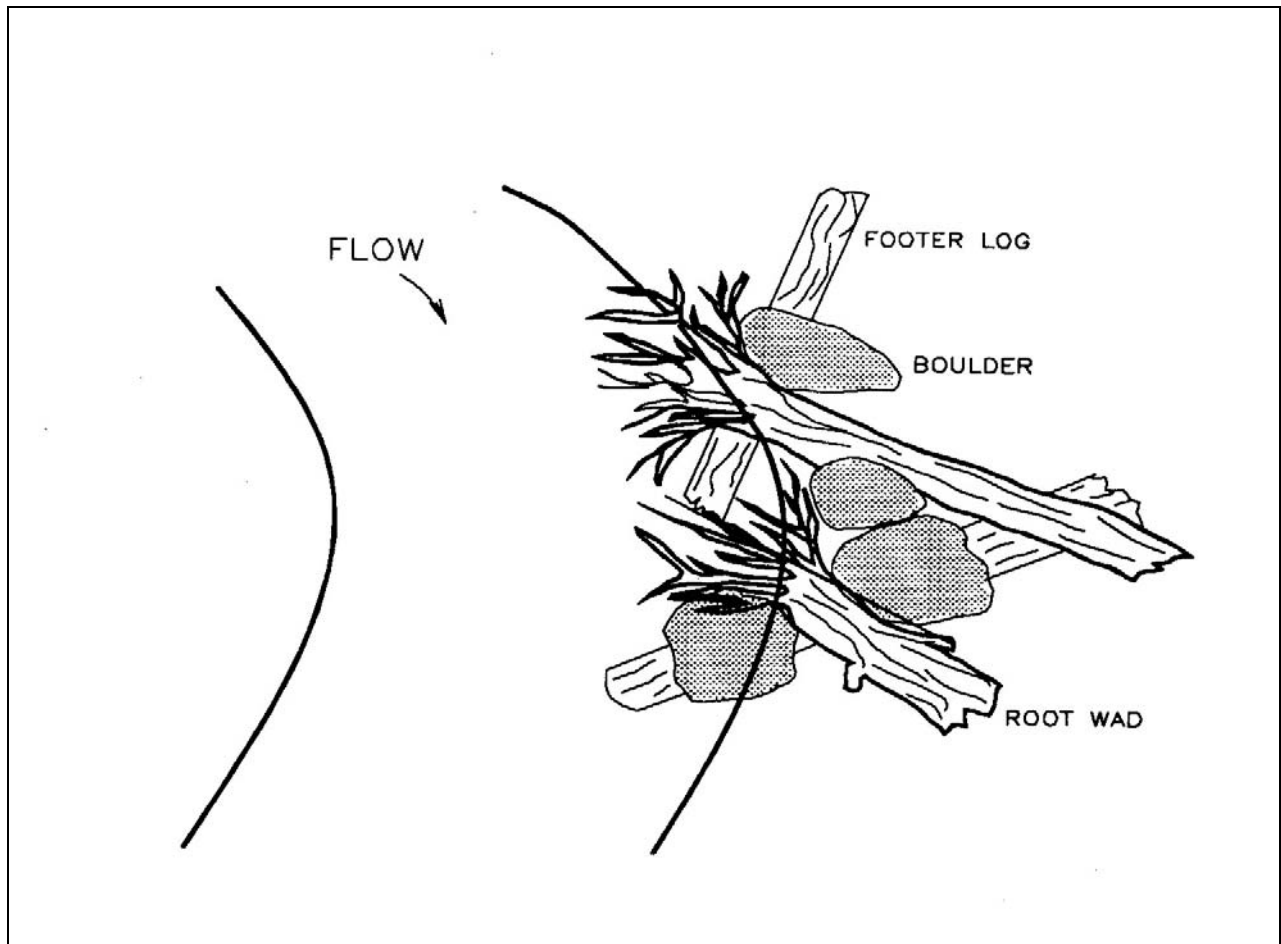

Figure VII-55. Plan view of native material revetment (Rosgen, 1993)

A backhoe or excavator are essential in construction of the revetment. The material sizes needed will vary depending on the stream size and hydrological factors. Logs, preferably redwood with root wads attached, boulders and live plant materials are placed in sequence to ensure stability and proper function of the structure.

Logs without root wads (footer logs) are set in a toe trench below the thalweg line, with the channel end pointed downstream and the butt end angled 45 to 60 degrees upstream. A second log with a root wad is set on top of the footer log diagonally, forming an "X." The root wad end is set pointing upstream and the butt end lying downstream 45 to 60 degrees. The apex of the logs are anchored with threaded rebar. Large boulders are secured in the spaces between the logs, at each apex. After all the logs and boulders have been set in place, any live plant material disturbed from

CALIFORNIA SALMONID STREAM HABITAT RESTORATION MANUAL

the site along with recruited willows are placed within the spaces of the structure, behind the boulders. Once this has been done the excavated gravel and streambed materials can be placed over the bank-end portion of the revetment (Figure VII-56).

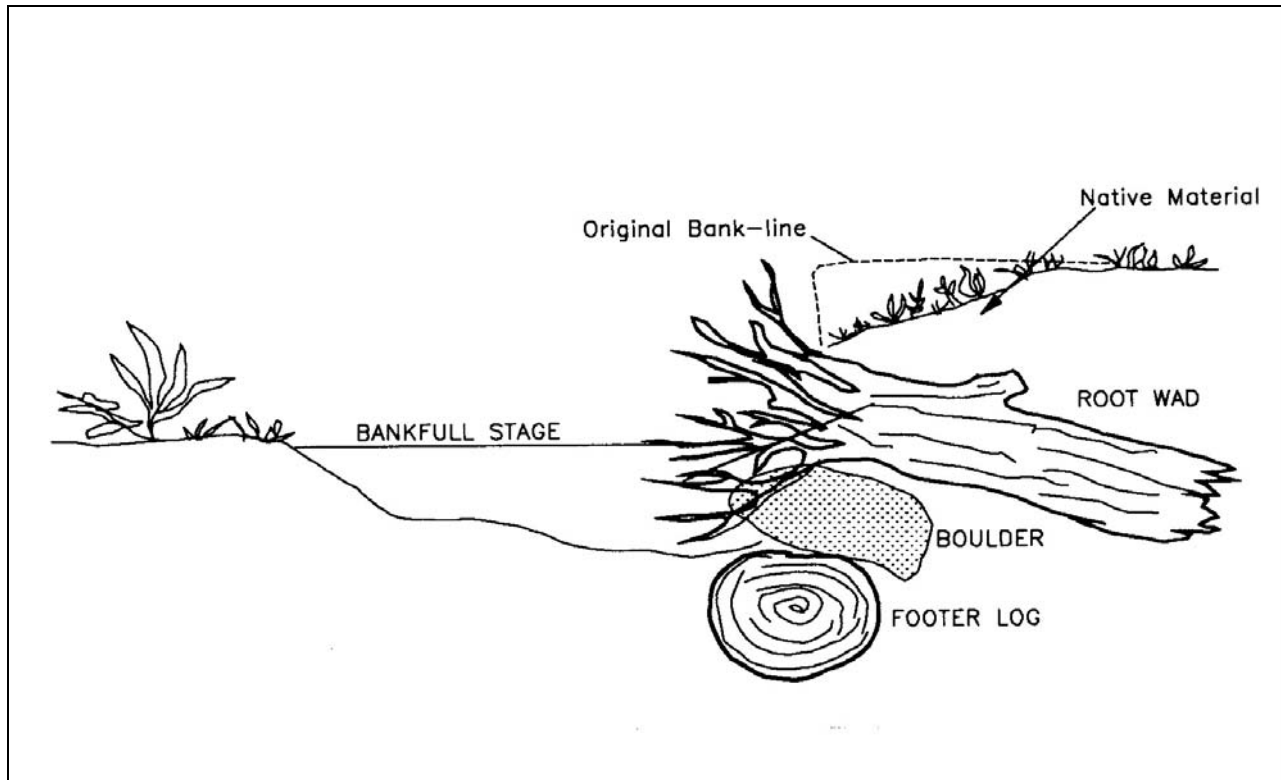

Figure VII-56. Native material revetment (Rosgen, 1993).

Mulching

Mulching for erosion control is covering soil with straw or similar material to discourage erosion and encourage revegetation. It is principally used to protect bare soil from rain and sheet erosion. In areas of heavy rainfall, erosion caused by raindrop impact can be significant. Mulching will also shade soil from the sun and prevent soil from drying. This assists in re-establishing vegetation by creating a stable seed bed and keeping soil moisture levels from becoming too low to sustain new vegetation.

Mulching can be accomplished by adding straw or forest leaf litter to bare soil. Other mulches can be used, but unwanted or exotic plant species may be introduced with them. Such plants can depress native vegetation and become established as a nuisance species. Leaf litter from the forest may be available for the cost of labor to collect it and will usually not contain seeds of undesirable species. Leaf mulches may have to be secured with jute netting. If it is necessary to buy and transport mulch, straw is the most economical and convenient but may contain seeds of undesirable plants. Straw mulch should be applied at the rate of two to three tons per acre. This results in a mulch coverage of about 80 percent. A 60 to 65 pound straw bale will cover approximately 500 square feet.

CALIFORNIA SALMONID STREAM HABITAT RESTORATION MANUAL

Revegetation

Planting or transplanting appropriate vegetation is a primary means for long-term restoration of the health of a watershed. Most other treatments are temporary measures until vegetative cover can be restored. Accelerating revegetation consists of selecting appropriate species for the treatment area and introducing them to a new site in a manner allowing them to prosper and grow. Appropriate species are usually those found growing nearby. Methods include planting stem cuttings from plants such as willow, cottonwood, thimbleberry, coyote bush, or other species that are able to root from cuttings. Planting container grown or bare root stock, such as alder, tan oak, *Ceanothus*, Douglas fir, redwood, and grand fir also is a good technique. Planting is appropriate for treatment of areas that have stable footing, adequate temperatures, and enough water for plant survival. Correct choice of plant species and proper planting technique are critical.

Transplanting

Relocation of plants found growing near the treatment site is sometimes appropriate. Some species are best acquired by thinning surpluses in nearby thickets and stands.

Revegetation with Willow Sprigs

Willow (*Salix*) sprigging (Figure VII-57) can be an effective and inexpensive way to armor active headcuts and eroding gully banks, and to stabilize stream banks where water is flowing parallel with the bank. Willows must be planted in sunny areas where the soil stays moist throughout the dry season. Sprigs should be collected and planted when the willows are dormant. However, sandbar willows do not sprig well and should be avoided; cottonwood is a good alternative to willows. Sprigs should be at least 1/2-inch in diameter and 18 inches long. Sprigs, 2 to 3 inches in diameter and 3 to 4 feet long work best, and should be used in the most actively eroding places. Cuttings should be planted the same day they are cut. If it is not possible, then the entire cutting should be placed in water in a cold area.

Willows respond well to heavy pruning, so they can be collected heavily from a grove. Thin, however, instead of clear-cutting in order to leave cover for resident fauna.

CALIFORNIA SALMONID STREAM HABITAT RESTORATION MANUAL

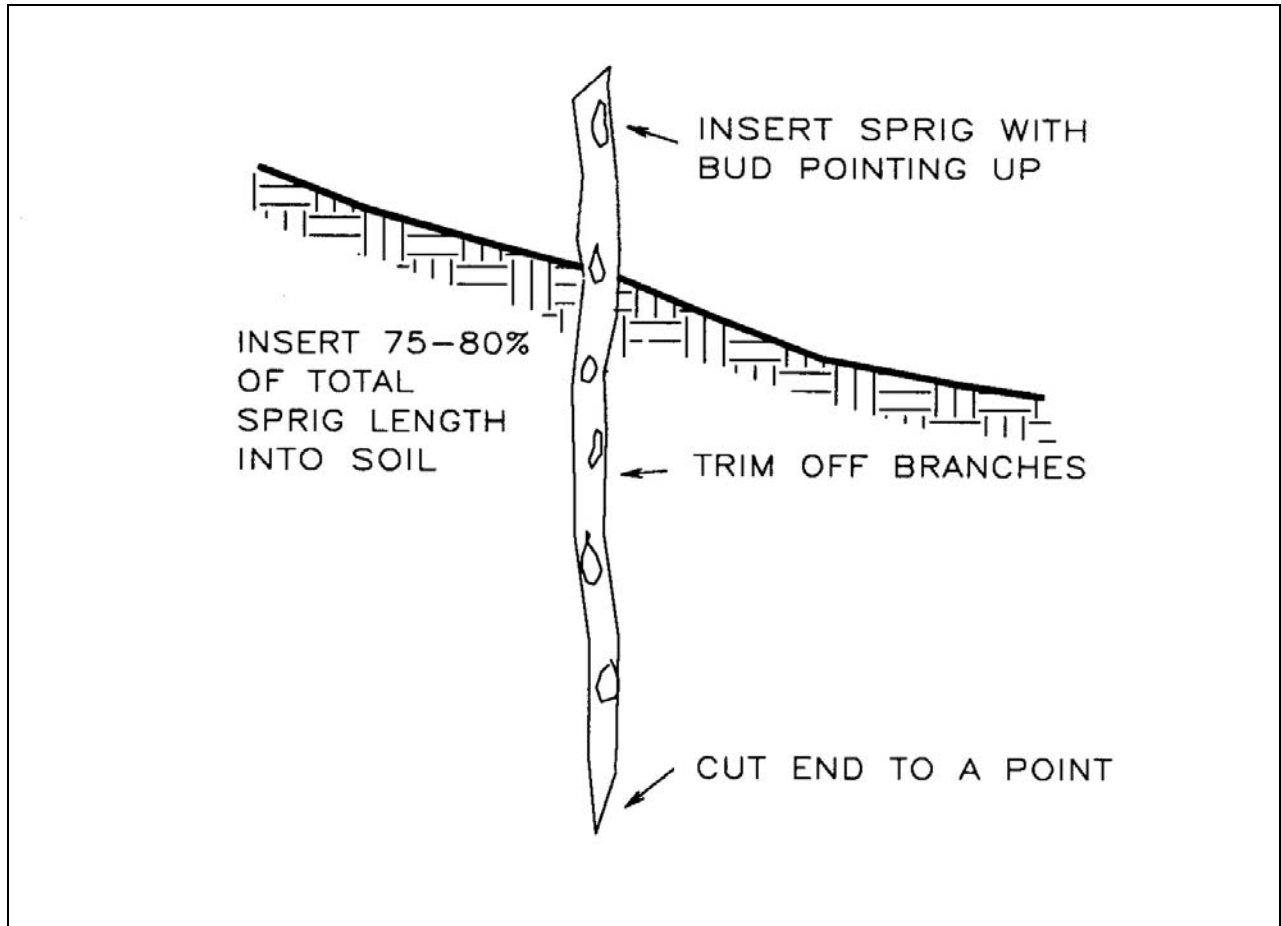

Figure VII-57. Willow sprigging. (Prunuske, 1987).

Plant the willows with the buds up, after sharpening the basal (bottom) end of the sprig with an axe or pruners right after it is cut from the tree. Sprigs should be driven into the soil 75 to 80 percent of their total length, at a slight angle downstream, to decrease their resistance to water flow. In hard soils an iron bar or a chain saw powered auger can be used to bore planting holes. After placing the cutting in the hole, tamp firmly around the cutting to remove air pockets in the soil. In soft soils, sprigs can be driven in with a wooden mallet or sledge hammer. Cut off the tops of the sprigs if they should split while hammering. Leave only one or two buds exposed.

In large rapidly eroding gullies, or along stream banks, appropriate spacing may be as close as one foot. In more stable gullies typical of relatively small watersheds, the sprigs can be placed 2 feet apart.

Cattle and deer tend to browse heavily on young willow. The revegetated areas may need protection by fencing, wire cones, or heavy netting.

CALIFORNIA SALMONID STREAM HABITAT RESTORATION MANUAL

Willow Wall Revetment

Willow wall revetments can be used for stream bank failures, eroding banks, and bank toe protection (Figure VII-58). Willow walls restrict sediment yield to a stream and also provide vegetation and canopy. The wall should be constructed along a stream bank at a height that will provide the willows with water during low flow months. If the wall is located upslope from the channel, irrigation may be required during summer months.

- 1) These walls are built at erosion sites along stream banks. If a rip-rap toe is desired, it should be placed below grade to prevent scouring. If more than one wall is to be constructed up a slope, there should be a three feet space between each successive wall.
- 2) Planting holes should be bored three feet apart from one end of the site to the other. Hole depth depends on the length of the willow poles being used. For example, an eight feet long willow pole requires a hole five feet deep. The poles should be two - three inches in diameter and as straight as possible. The poles should be set with the tops up and leaned slightly towards the bank at approximately a 15° degree angle to allow for the weight of the earth fill to be added later.
- 3) After the poles have been set and tamped, long, flexible willow branches from 3/4 to 2" in diameter are tightly woven through the standing poles. The woven branches should be packed down as tightly as possible. Both the woven material and the poles should be stripped of all small branches and tops less than two inches in diameter. These can be used later in the back fill brush material.
- 4) Once the wall is constructed, a backing of biodegradable erosion cloth or netting should be placed against the woven willow pole wall on the bank side. Using smaller tops and green willow branches, create a brush pack approximately one foot wide behind the netting. Backfill the wall with firmly packed down soil. All disturbed soil areas are mulched with litter and seeded. Each end of the wall can be anchored with 3/8" cable and attached to duck bill anchors to add stability.

CALIFORNIA SALMONID STREAM HABITAT RESTORATION MANUAL

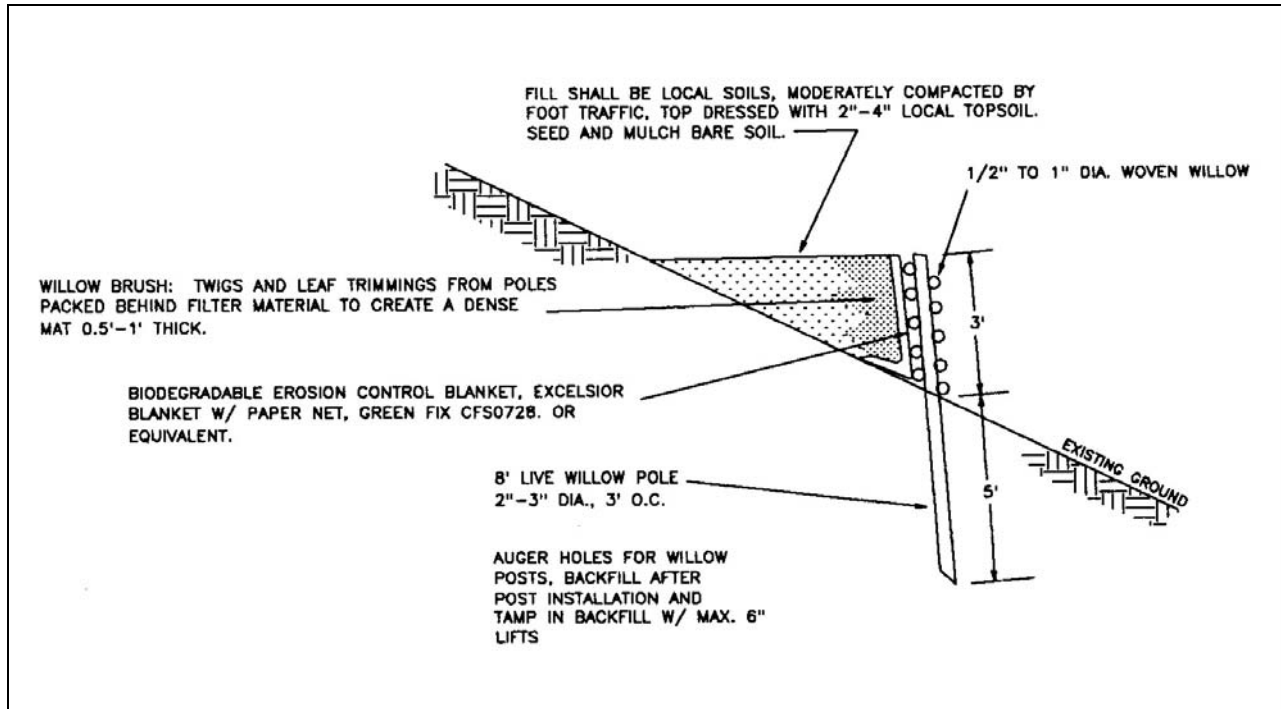

Figure VII-58. Willow Wall Revetment (L. Prunuske, 1997).

Brush mattress

Brush mattresses work well for bare eroding streambanks (Figure VII-59). These mattresses protect the stream banks from erosion caused by exposure and scour.

- 1) The disturbed bank should be sloped and smoothed to ensure that all willows are in contact with the soil. Excavate a toe trench two feet below streambed elevation at the base of the bank for the butt ends of the willow branches.
- 2) Partially drive wood, steel, or live willow stakes in rows on three foot centers along the area of the bank that will be covered by the mattress. After the stakes have been placed, lay live willow branches on the bank with their butt ends in the trench. It is best to use straight branches no shorter than four feet in length and approximately 2 to 1" in diameter. Place approximately twenty to fifty branches per linear yard, depending on their diameter. If the branches are not long enough to cover the upper bank area, several layers may be used, but it is necessary to lap, or "shingle," each added layer with the layer below it by at least eighteen inches (Figure VII-60).
- 3) Once the bank has been covered with a thick layer of willows, cross branches are placed horizontally over the bottom layer. These branches should be placed against the stakes and then tied to the stakes using wire or string.

CALIFORNIA SALMONID STREAM HABITAT RESTORATION MANUAL

- 4) The stakes are then driven into the bank a minimum of two feet. The deeper the stakes are driven in, the tighter the mattress will be held against the soil of the bank. After completion of the mattress, the trench should be filled with small boulders or rocks to anchor the butt ends of the branches. The entire mattress should be lightly covered with earth or fine streambed material.

Stream channel dimensions, hydraulic factors, available material and other factors may dictate variations to this general design.

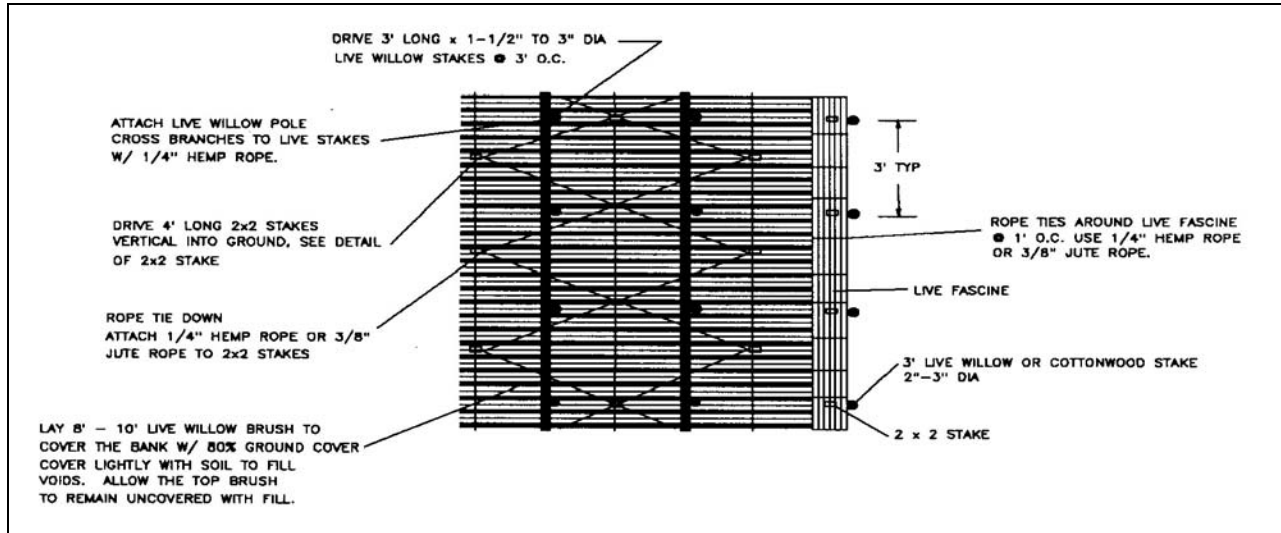

Figure VII-59. Brush Mattress Plan View (L. Prunuske, 1997).

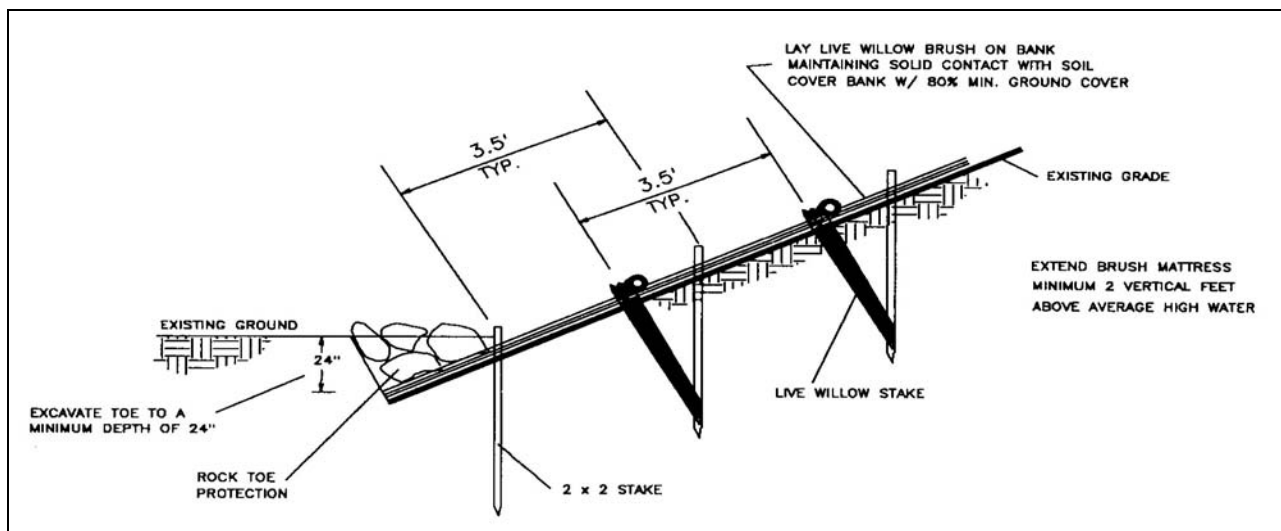

Figure VII-60. Brush Mattress Cross Section (L. Prunuske, 1997).

CALIFORNIA SALMONID STREAM HABITAT RESTORATION MANUAL

Willow Siltation Baffles

Willow siltation baffles are inexpensive structures that can achieve several objectives. Their function is similar to a wing deflector which can be used for bank protection and energy dissipation, as well as for channel constriction. Willow baffles are designed to work in series and pass flow through the structure, sort bedload, dissipate energy, and trap fines.

- 1) Dig toe trenches perpendicular to the bank approximately 1 2 - 3' deep. Extend the trenches into the stream channel a short distance. The baffles should be keyed into the bank at least three feet. The excavated material removed from the trench should be placed along the downstream side of the trench. Each successive baffle is installed at different angles. The most upstream baffle is placed at an acute angle with the bank, and the following baffles are placed at right-angles. The lower baffle is placed at an obtuse angle. The number and length of baffles is dependent on the dimensions of the stream channel and treatment area (Figure VII-61).

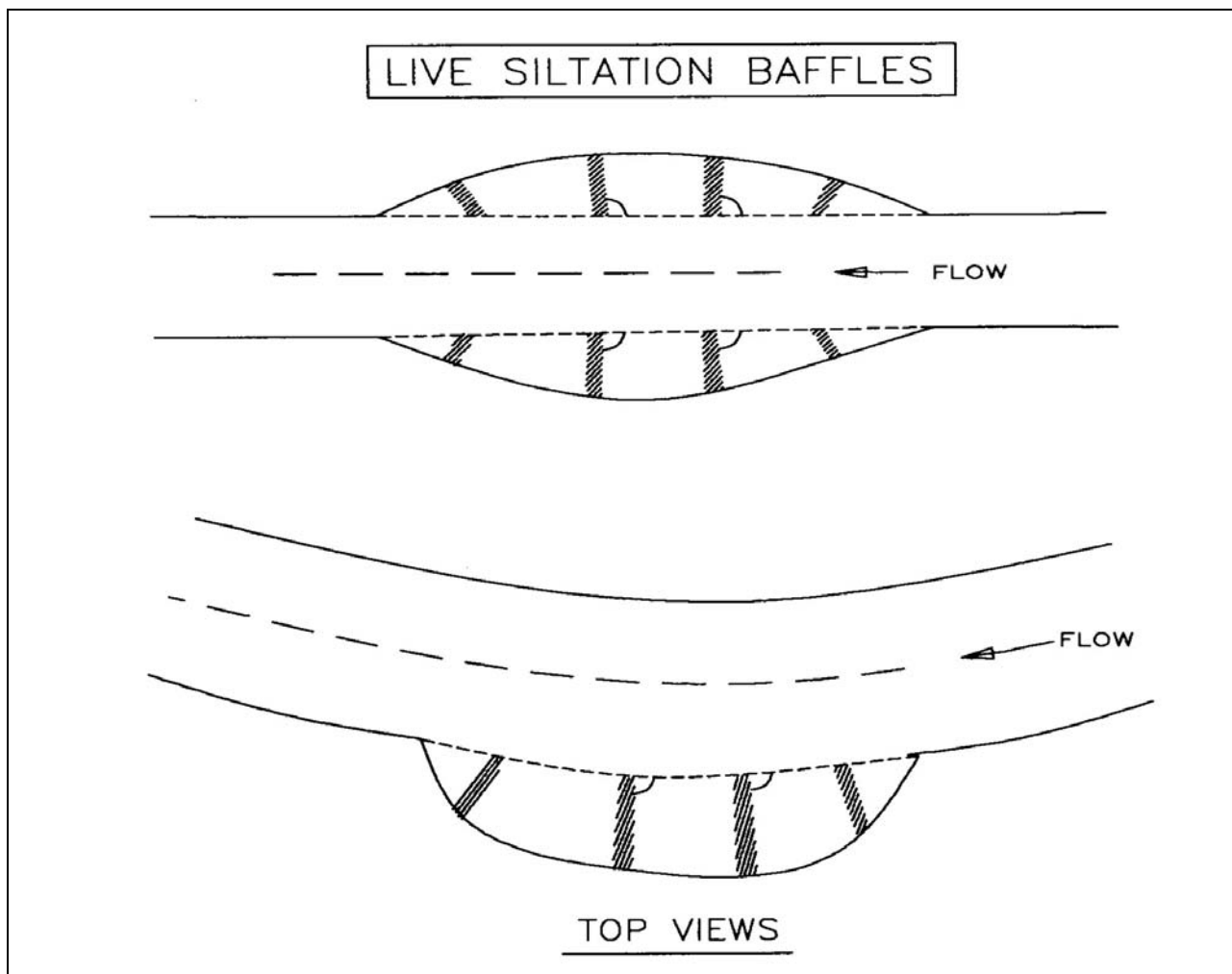

Figure VII-61. Arrangements of baffles (Schiechl and Stern, 1996).

CALIFORNIA SALMONID STREAM HABITAT RESTORATION MANUAL

- 2) Willow branches approximately three to six feet long and 1/2" in diameter are placed in the trench pointing downstream. The ends of the baffles that extend into the channel have the willow branches wrapped around, forming an upstream facing "J." (Figure VII-62) The willows are densely packed with no gaps and form a standing mat. The trench is then back filled with streambed material and small cobble. Some topsoil may be placed at the bottom of the trench to help with root formation. Larger stone is placed on top of the backfill in order to secure the willow branches. The largest rocks available should be placed on the stream channel end of the baffle. Site specifications will be unique to stream channel dimensions, hydraulic factors, and available material and will dictate variations to this general design (Figure VII-63).

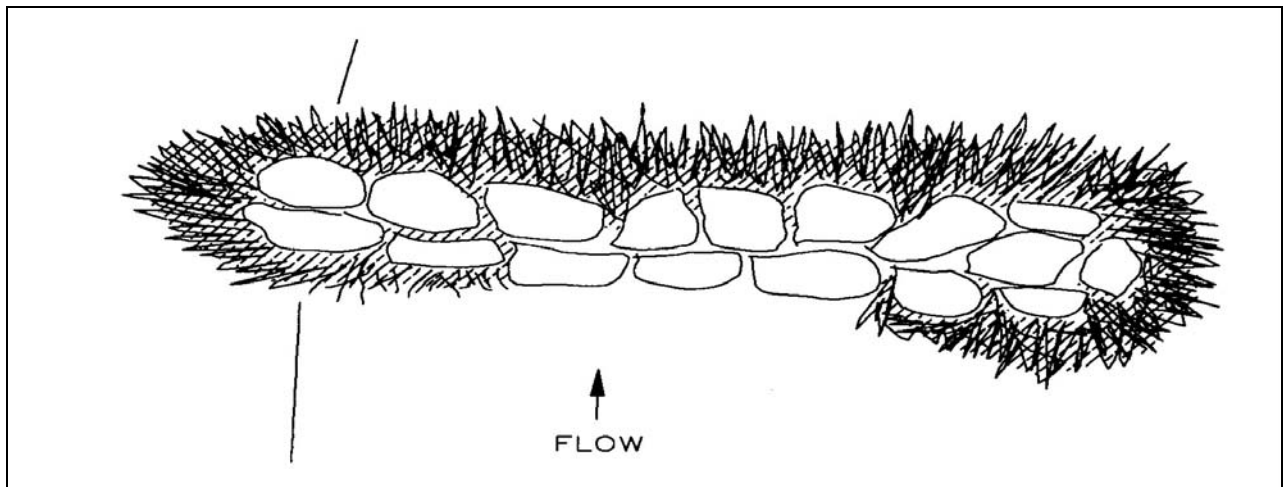

Figure VII-62. Top view of baffles (Schiechtl and Stern, 1996).

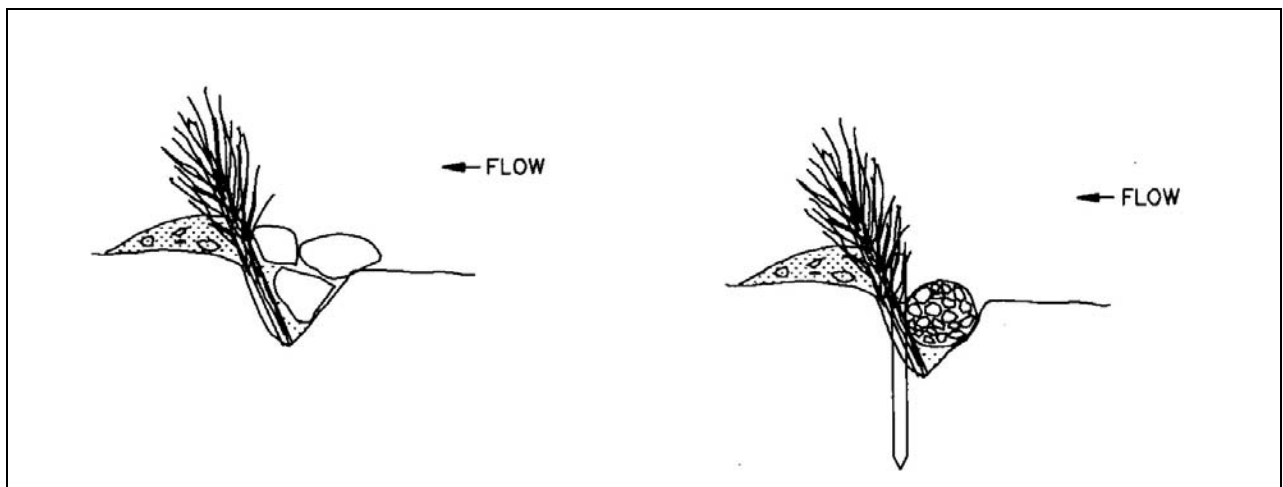

Figure VII-63. Side view of baffles (Schiechtl and Stern, 1996).

CALIFORNIA SALMONID STREAM HABITAT RESTORATION MANUAL

Planting Seedlings

Seedlings can be planted with shovels or western planting tools (also known as hoedads or planting hoes) in most situations. Planting bars may be used if the soil is not too rocky or compacted.

Power augers with carbide-tipped bits are also recommended for planting. Power augers come in two types: one with its own power head, and a second type that attaches to a chain saw power head.

A bucket, waterproof planting bag, or similar container is needed for carrying trees in the field. Use sawdust, peat moss, vermiculite or other moist material around the roots of bare root seedlings to keep them damp at all times. Do not keep seedlings immersed in water since it reduces oxygen and plants may suffocate. In some areas it is necessary to use shade cards or shingles to shelter seedlings. Plastic netting or tubes, spray repellents, or bud caps can be used to protect plants from animal damage.

Seedlings are delicate and must be handled carefully (Figure VII-64). For highest survival, treat trees carefully, and plant them immediately. If planting must be delayed a few days, keep the boxes in a cold, protected place. For containerized seedlings, cut the box down level with the container so that air can circulate between the trees. Keep trees out of rain and wind. To check if trees need water, feel the media at the bottom of the tube. If it is not damp, water the trees, and allow excess water to drain. In cool, damp weather, the biggest threat to seedlings is from mold.

CALIFORNIA SALMONID STREAM HABITAT RESTORATION MANUAL

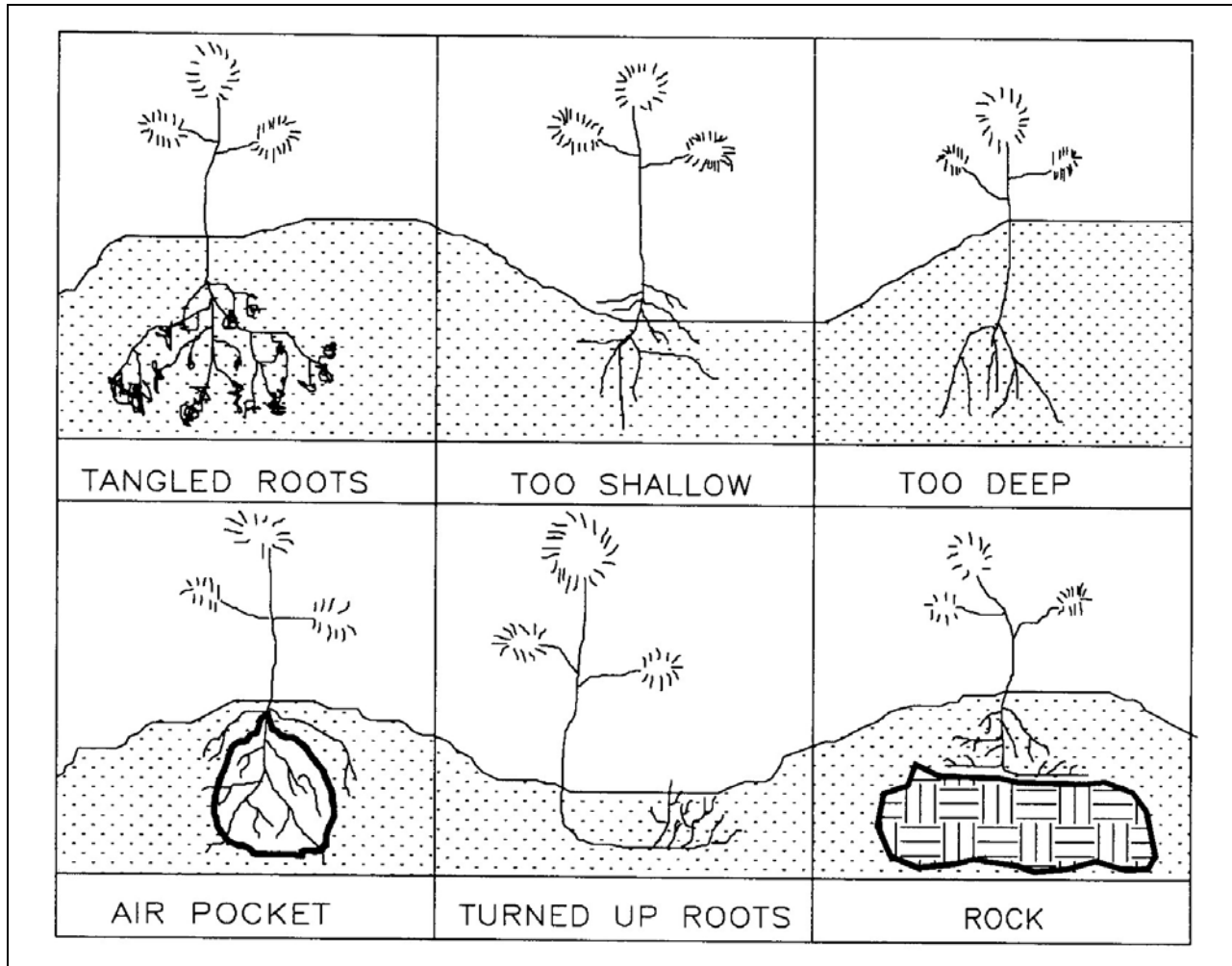

Figure VII-64. Problems to avoid during tree planting.

Ideal storage conditions for bare root seedlings are a temperature of 33E Fahrenheit and high humidity. If available, refrigerated storage is best. Check packing material around roots to make sure it is moist. If it is drying out, wet thoroughly and allow excess water to drain off. Keep roots moist, but not the tops. Wet tops can easily become moldy. The biggest threats to bare-root seedlings are dried roots and mold formation; which occurs if the trees become too warm.

Ideal planting days are cool and cloudy, with little or no wind. If possible, avoid planting on warm, windy days. The soil should be moist. Care in planting is more important than speed. Make sure roots never become dry. Planters should only carry about 50 trees at a time. Trees should be carried in a waterproof bag or bucket with plenty of moist material packed around the bare roots to keep them damp. Trees remaining in boxes should be left in boxes and kept in a cool, shady place. Ideally, bare root boxes should be kept refrigerated or packed on ice or snow.

Competition from weeds, grass, brush or other trees can kill or retard growth of seedlings. Choose areas free from this competition, or clear at least a three-square-foot area before planting. Seedlings should not be planted under direct shade of trees, or closer than 6 feet to existing brush, unless lethal temperatures are anticipated.

CALIFORNIA SALMONID STREAM HABITAT RESTORATION MANUAL

Clear away loose organic material such as leaves, grasses, etc. from the planting spot to expose mineral soil. If organic matter gets into the planting hole, it can decompose and leave air space. Roots will dry out when they grow into these spaces.

Open up the hole, making sure it is deep enough for the roots to be fully extended (Figure VII-65 and Figure VII-66). Take a tree out of the planting bag or bucket only after the hole is ready. When exposed, fine roots can dry out in as little as 30 seconds. Remember to remove the container before planting a containerized tree. This can be done by cutting container or by pushing up gently on the roots with a stick or broom handle. If roots are curled or bunched up, the tree will not be able to absorb water correctly, will often weaken and die, or may blow down in later life due to poor root structure.

After removing a seedling from the container, hold it in place in the hole, making sure roots are straight, fully extended, and that the seedling is neither too shallow nor too deep. Fill the hole, allowing soil to fall in around the roots. Tamp with hands or with your heel. Fill with more soil, if necessary, and tamp. Tamping is important. If soil is not firmly packed around the roots, air pockets will remain that can dry the roots, and the seedling may be weakly anchored. Addition of fertilizer and plant vitamins at the time of planting is not generally necessary.

Again, care is more important than speed. In regard to spacing, it is better to pick a planting spot shaded by a stump, log or rock, than to strictly follow recommended spacings. During planting of riparian species, care should be taken to ensure that roots have ready access to moist soil.

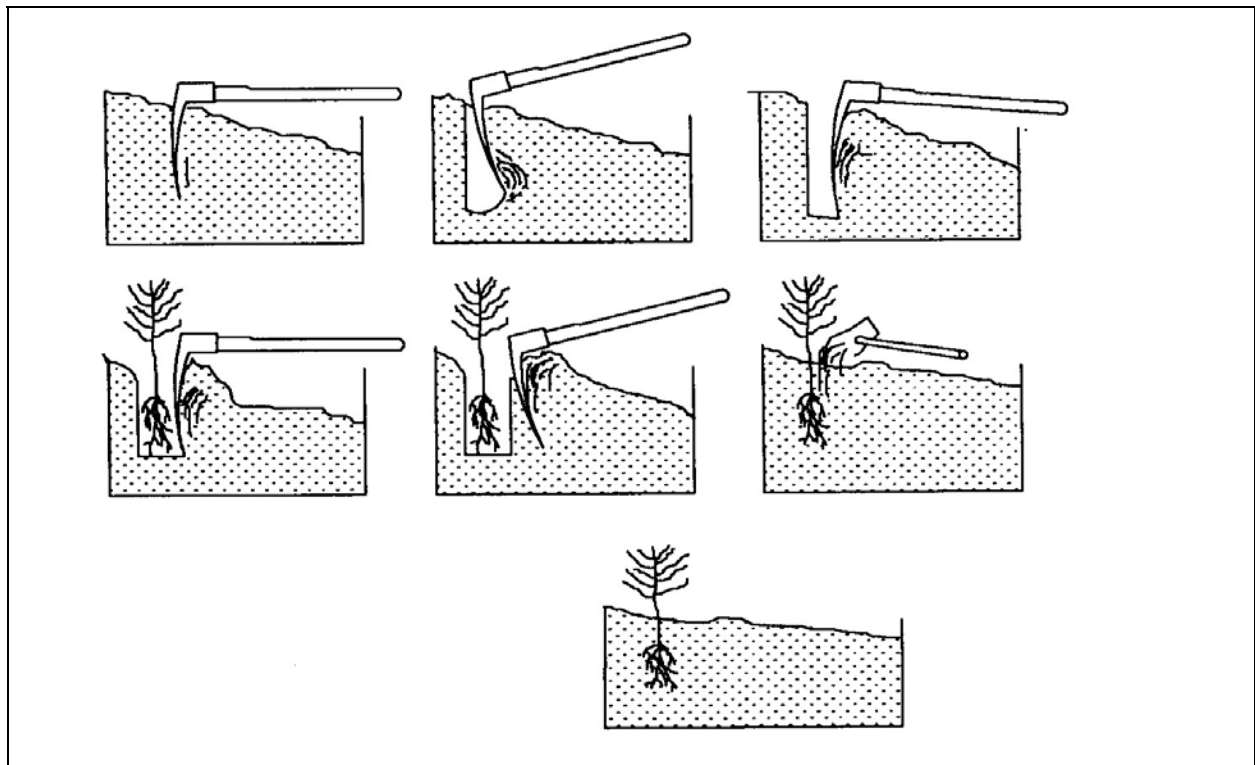

Figure VII-65. Steps in tree planting with hoedads. (California Department of Forestry, 1978).

CALIFORNIA SALMONID STREAM HABITAT RESTORATION MANUAL

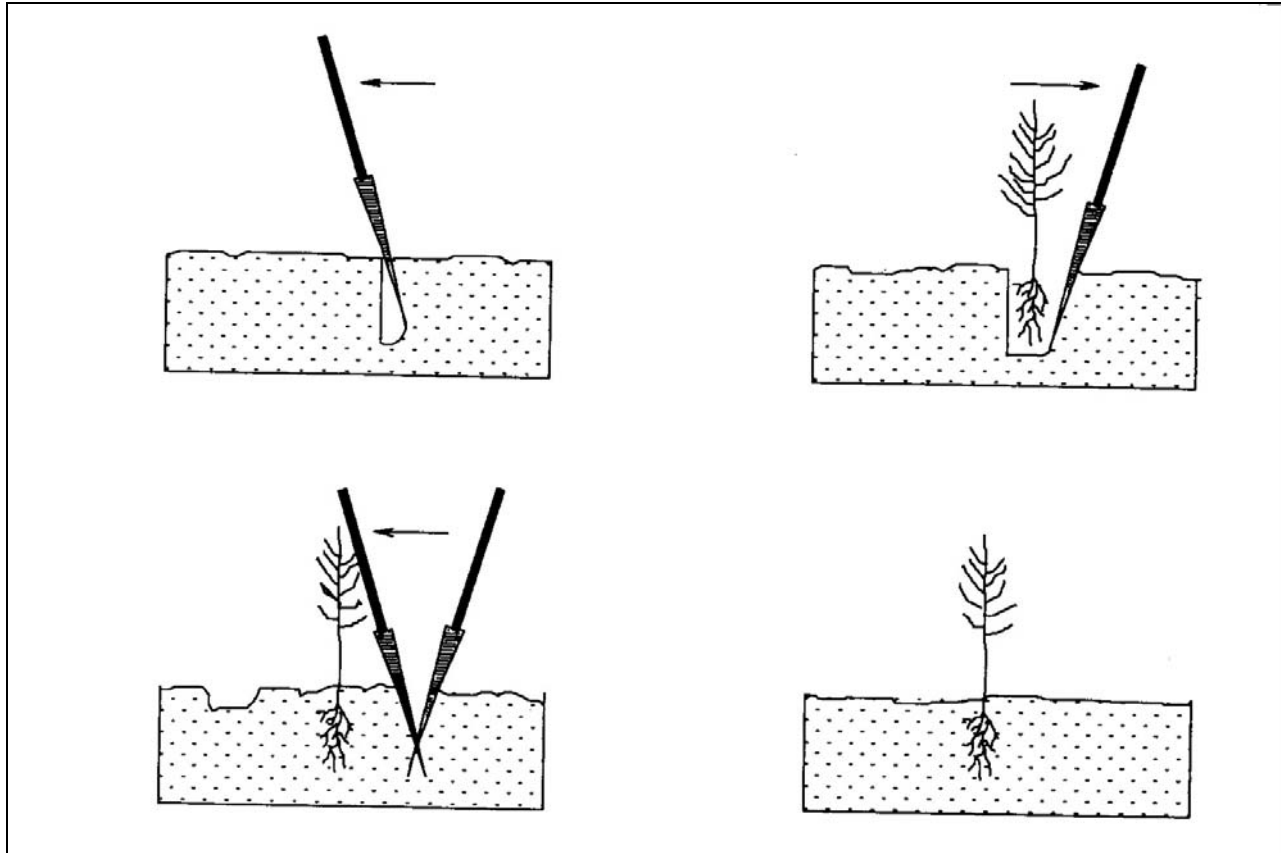

Figure VII-66. Tree planting. Planting bar method. (California Department of Forestry, 1978).

Checkdams

Checkdams are small dams constructed across a gully, ditch, or stream to reduce water velocity and trap sediment. All checkdams fall into two broad categories: permeable and impermeable. Permeable check dams allow water to pass through the dam face. Sediment is deposited more slowly above them than if water flow is stopped completely, but such dams are more resistant to blowouts than impermeable dams. Checkdams can be constructed from a variety of materials. Materials used to construct permeable checkdams include strawbales, woven willow branches, brush, loose rock, gabions, and logs. Impermeable checkdams include redwood board, compacted earth, mortared rock and concrete structures. Table VII-1, Selecting a checkdam type, summarizes various checkdams and their uses.

Guidelines for checkdam construction:

- A series of low dams is usually more effective than fewer high dams.
- Use a hand level to space checkdams so that the toe of one is level with, or slightly below, the spillway of the next downstream dam (Figure VII-67).

CALIFORNIA SALMONID STREAM HABITAT RESTORATION MANUAL

- All impermeable dams and most permeable dams require a spillway to reduce bank erosion and lessen the possibility of the stream eroding a new channel around the structure. The spillway should be large enough to accommodate normal storm flows. Be careful to aim spillway discharge toward the bottom of the gully, not the sides, even if this requires that the spillway be off-center.
- Always provide a non-erodible energy dissipator (or apron) for the checkdam discharge.
- The top of the checkdam must be level.
- Key all checkdams securely into gully banks and bottom.
- Construct checkdams perpendicular to flow.

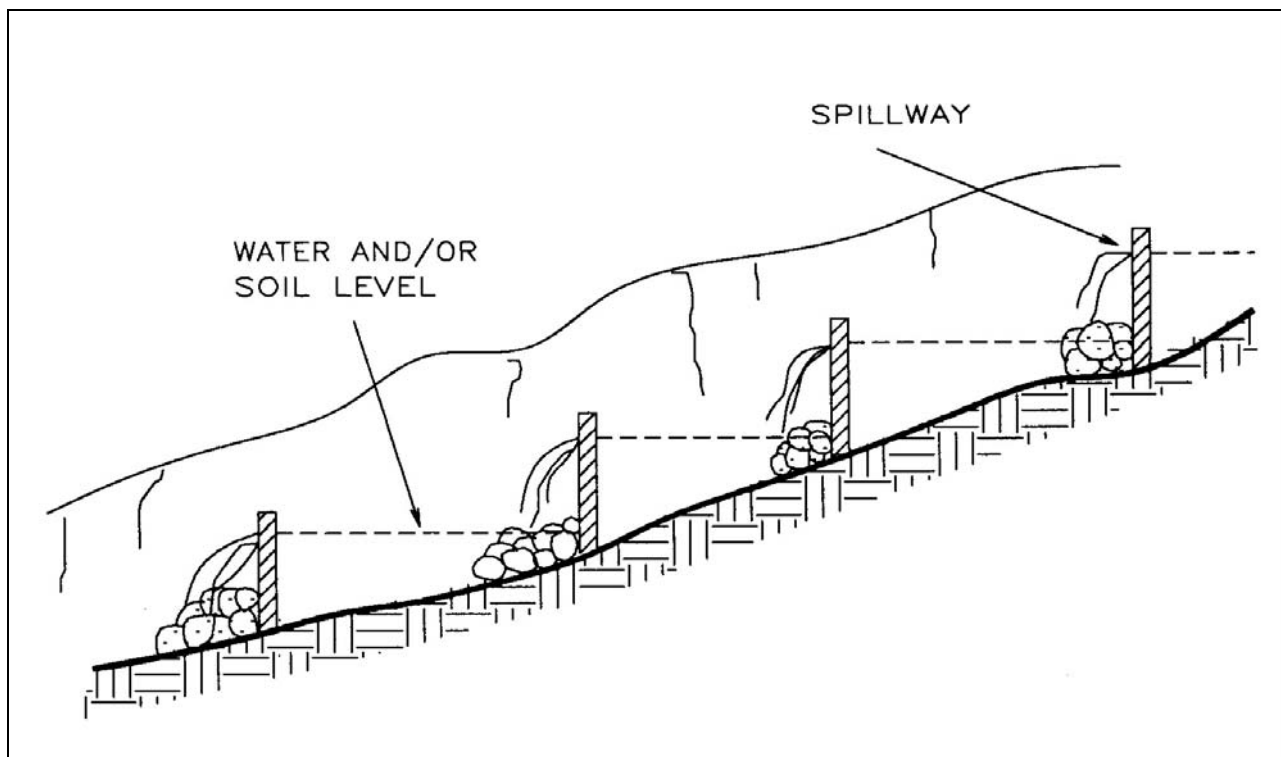

Figure VII-67. Checkdam placement. (Prunuske, 1987).

CALIFORNIA SALMONID STREAM HABITAT RESTORATION MANUAL

Table VII-1. Selecting a checkdam type (Prunuske, 1987).

Type of Checkdam	Gully Activity*	Optimum Gully Size	Soil Particle Size	Durability	Special Site Conditions	Common Reasons for Failure
Strawbale	low	3-6 ft. wide, up to 3 ft. deep	fine to coarse	2-3 years	Use only in areas that can be seeded or where natural vegetation will occur quickly.	Bales not keyed into banks and bottom securely; animal damage; gully too active; no follow-up revegetation.
Woven Willow	low	up to 4 ft. wide, up to 3 ft. deep	coarse	indefinite	Use only in winter swales and where minor flooding is acceptable. Best in gravelly soils with high organic content.	Sprigs planted upside down, too sparsely, not deep enough or too late; insufficient water in dry season; animal damage.
Brush	low to moderate	up to 4 ft. wide, up to 3 ft. deep	coarse	2-3 years indefinite if live willow stakes used		Brush not anchored securely; insufficient amount of brush; large poles used instead of smaller, leafy branches.
Loose Rock	low to high	up to 10 ft. wide, up to 10 ft. deep	fine to coarse if filter fabric used	indefinite	Rock on-site, or site accessible to dumptruck or loader.	Rock too small; not securely keyed into banks and bottom; spillway too small.
Gabion	low to high	One gabion width less 2 ft. key width, 3-10 ft. deep	fine to coarse if filter fabric used	20+ years	Rock on-site, or site accessible to dumptruck or loader.	Not securely keyed to banks and bottom; energy dissipator does not extend far enough downstream; spillway too small.
Log	low to moderate	up to 4 ft. wide, up to 3 ft. deep	coarse	5-20 years depending on type of wood	Works best in gravelly soils with much organic matter such as leaves and twigs.	Not securely keyed to banks and bottom; energy dissipator does not extend far enough downstream; gaps between logs too large; spillway too small.
Redwood Board	low to high	2-10 ft. wide, 2-5 ft. deep	fine to coarse if filter fabric used	20+ years depending on quality of redwood		Not securely keyed to banks and bottom; poor quality wood used; energy dissipator inadequate; active gully bank erosion; spillway too small.
Grouted Rock	moderate to high	3-10 ft. wide, 3-10 ft. deep	fine to coarse	50+ years		Not securely keyed to banks and bottom; air spaces left between rocks; energy dissipator inadequate; spillway too small.
Concrete	moderate to high	3-10 ft. wide, 3-10 ft. deep	fine to coarse	50+ years		Not securely keyed to banks and bottom; energy dissipator inadequate; spillway too small.
Compacted Earth	high	10-40 ft wide, 10-30 ft deep	fine to coarse	indefinite	Check with design engineer	Insufficient soil compaction; spillway not protected with non-erodible armor; energy dissipator too light and/or does not extend far enough downstream.

- * Low** - Headcut is shallow (less than 3 feet deep) and does not grow noticeably during heavy rainfall. Banks are gently sloped and mostly covered with grass, tree roots or other vegetation.
- Moderate** - Headcut is shallow, but expands noticeably during winter storms. Banks are gently sloped and mostly covered with vegetation with occasional steep areas of raw, exposed soil.
- High** - Headcut is more than 3 feet deep and moves rapidly uphill during heavy rainfall. Banks are steep with little vegetation.

CALIFORNIA SALMONID STREAM HABITAT RESTORATION MANUAL

Redwood Board Checkdams

Redwood board checkdams are suitable for spans up to 10 feet wide and up to 3 feet high. The redwood should be heartwood and free of large knots (Figure VII-68).

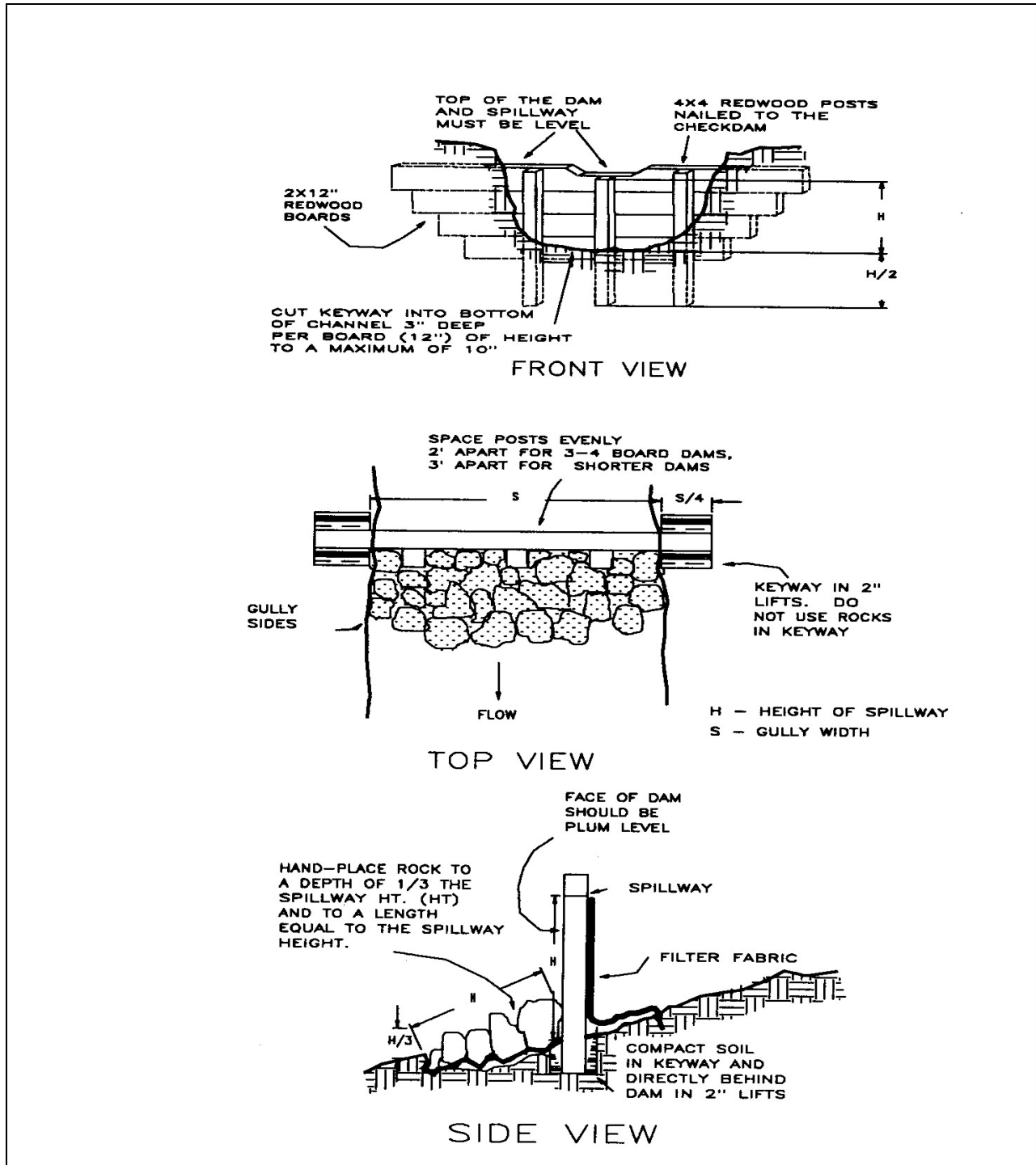

Figure VII-68. Redwood board checkdam. (Prunuske, 1987).

CALIFORNIA SALMONID STREAM HABITAT RESTORATION MANUAL

Brush Checkdams

Brush checkdams are very suitable to treat erosion sites in ephemeral gullies and headcuts. Their porous design allows water to pass through the structure and retain sediment. Since they are not hard obstructions, they do not divert water and cause bank scour. Live willow, cottonwood, fir and other types of branches which are usually pruned from the lower eight feet of a tree trunk can be used as "brush" in the construction of these dams. Any fine textured vegetative material raked up from under trees such as forest duff, pine needles, leaf mulch, straw, and rotted log pieces broken down with a hoe or mattock can be used as "litter" for mulch in each project type. These vegetated check dams can be constructed in a series or singularly in the same manner as the other check dams discussed.

Brush and Rock Checkdam

These are suitable for use within small, low activity ephemeral gullies (Figure VII-69).

- 1) Grade the gully banks to the slope angle of existing undisturbed banks. Retain the excavated soil for later use at completion of the project.
- 2) Place a six inch layer of litter along the gully's bottom and along the sides to be treated.
- 3) Beginning at the downstream end of the gully, place an eight inch thick apron layer of brush on top of the litter. Butt ends must point downstream.
- 4) Near the upstream end of the brush apron layer, stack a row of rocks on top of the brush layer about one foot high perpendicular to the gully. When available, flat rocks are the most stable and preferable.
- 5) Place about a four foot layer of brush parallel to the gully, butt ends downstream, and extending just downstream over the rock dam.
- 6) Place another row of rocks at least one foot high across the middle of the brush layer. While adding rocks, walk on the brush to compact it as much as possible.
- 7) Repeat steps 4 - 6 to raise the dam to the desired height.
- 8) Weigh the last layer of brush with a row of rocks to hold it in place.
- 9) Cover the upstream face of the dam with the soil excavated during the initial site grading process. Mulch the soil layer with a four inch layer of litter. Disturbed areas not treated by the brush should be seeded and mulched.

CALIFORNIA SALMONID STREAM HABITAT RESTORATION MANUAL

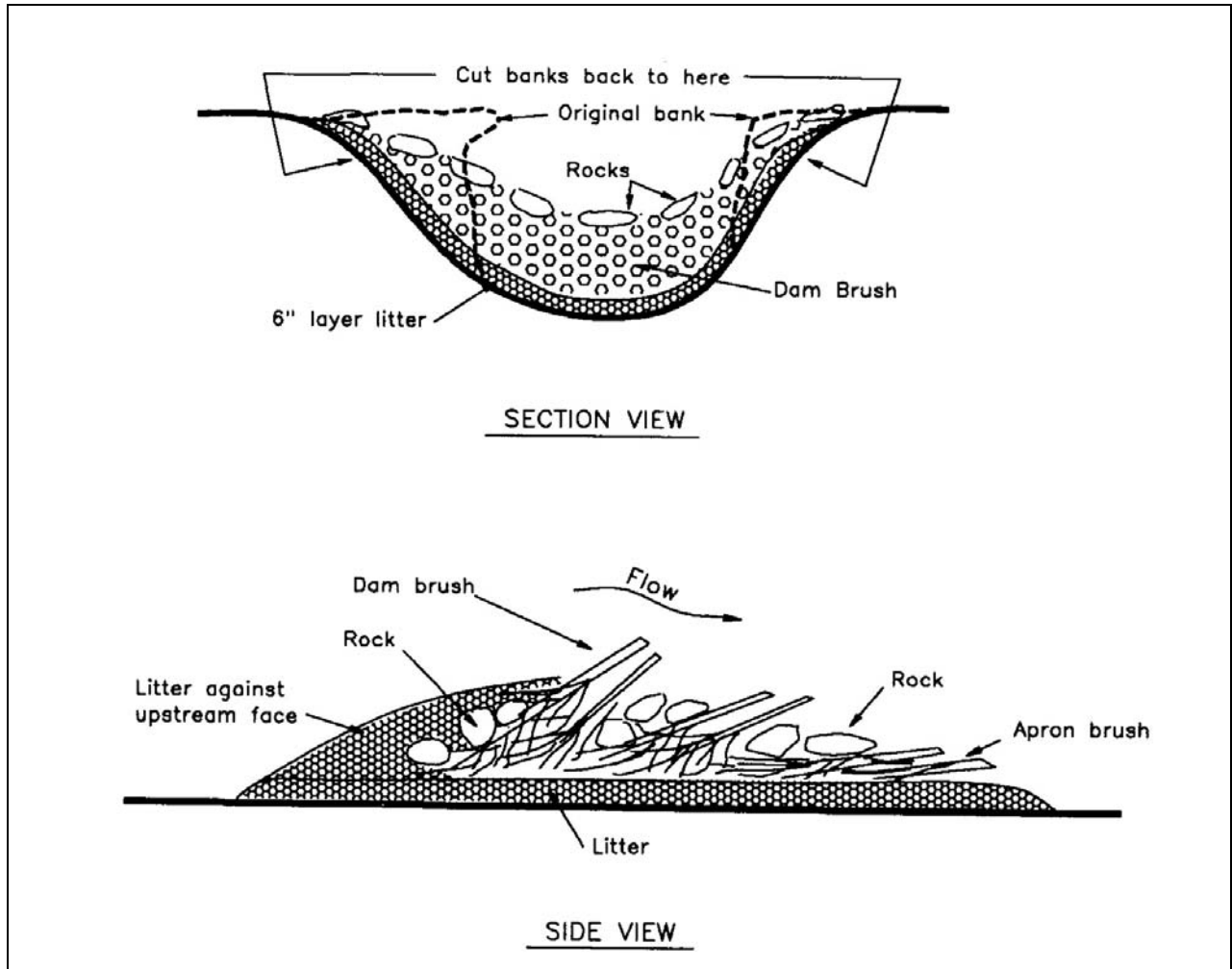

Figure VII-69. Brush and Rock Checkdam (Kraebel and Pillsbury, 1934).

Post Brush Checkdam

These are suitable for use within large, moderate to high activity ephemeral gullies (Figure VII-70).

- 1) Grade the gully banks to the slope angle of existing undisturbed bank. Retain the excavated soil for later use at completion of the project.
- 2) Metal "T" posts, or wooden posts two to four inches in diameter, should be set on two foot centers across the watercourse and be driven a minimum of eighteen inches into the ground. Live willow poles can be used if high ground water is present year round.
- 3) Layer small diameter brush parallel to the gully to act as a filter and soil erosion blanket. Each layer should be approximately six inches thick. The butt ends should extend beyond the posts at least six inches in an upstream direction.
- 4) Weave brush material through the posts at least one foot thick and continue adding material to the top of the posts. Attach branches or boards across the posts using rope or string to

CALIFORNIA SALMONID STREAM HABITAT RESTORATION MANUAL

hold the brush down firmly. Compact each layer of branches to ensure that no large gaps are present in the checkdam. At completion, the brush should be layered to the tops of the banks while leaving the middle section slightly lower to form a channel for flow.

- 5) Seed and mulch any disturbed areas after completion. Erosion cloth may be applied, if desired, behind each checkdam.

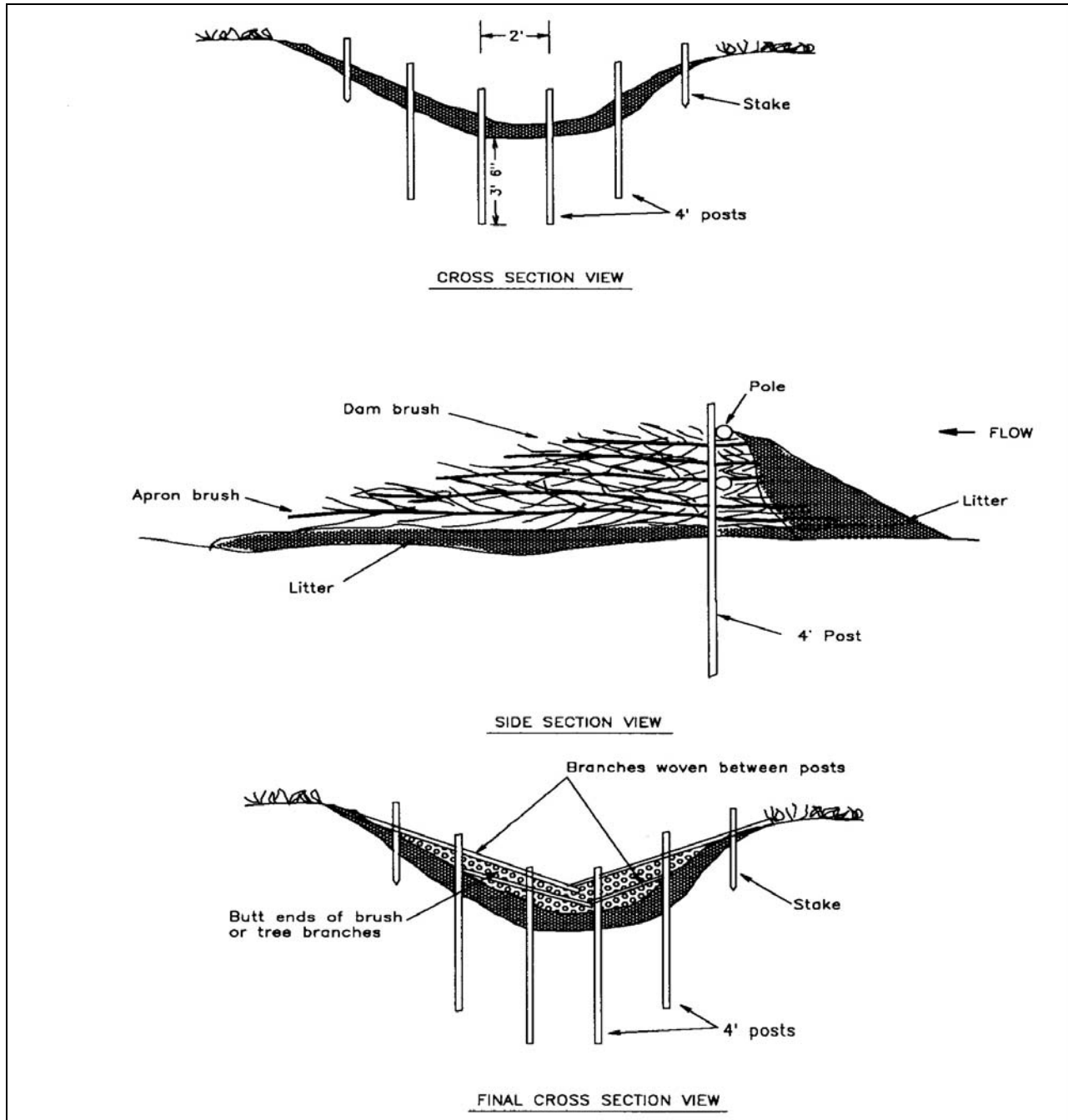

Figure VII-70. Post Checkdam (Kraebel and Pillsbury, 1934)

CALIFORNIA SALMONID STREAM HABITAT RESTORATION MANUAL

Tree Checkdam

This technique can be used where small trees are plentiful and need thinning (Figure VII-71).

- 1) Grade the gully banks to the slope of its undisturbed bank slopes. Retain the excavated soil for later use at the completion of the project.
- 2) Place a six inch layer of litter along the gully's bottom and its sides where the first row of trees will be placed to form an apron.
- 3) Lay the first row of small trees (< 8' tall), butts downstream, across the gully and up the sides to form the apron.
- 4) Continue stacking several layers of trees, butts downstream, across the gully bottom and up the sides, staggered in an upstream direction. They should be piled to the desired height in the center of the gully, and several feet higher on the banks depending upon the depth of the gully.
- 5) If available, large rocks placed on the upstream end of the apron will increase the stability of the dam, especially in a gully subject to high flows.
- 6) Finally, place the soil excavated during the earlier grading process against the upstream face of the dam, and cover it with a two to three foot layer of litter. Seed and mulch disturbed areas.

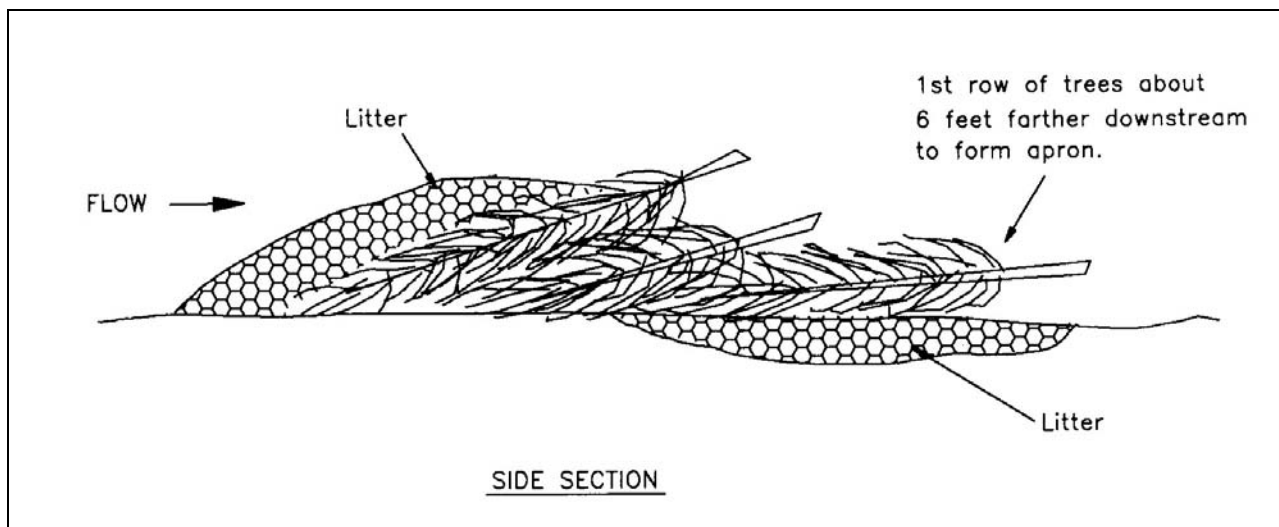

Figure VII-71. Tree Checkdam (Kraebel and Pillsbury, 1934)

CALIFORNIA SALMONID STREAM HABITAT RESTORATION MANUAL

Brush and Rock Mattress Headcut Repair

A headcut is a vertical break in slope at the uphill end of a gully or section of gully. Some gullies have multiple headcuts. Headcuts form a waterfall plunge which causes soil to erode from the scour of the cascade. This loss of soil causes the gully to migrate uphill. Headcuts often occur when water is concentrated by road drainage systems below stream crossings. Headcuts are also often associated with slope slumping along stream banks or in upslope areas.

- 1) Grade the banks near the upper end of the headcut to the slope of existing undisturbed bank slopes.
- 2) Place a six inch layer of litter in the gully and its side slopes along the area to be treated.
- 3) Cover the litter with a apron layer of brush. Start at the downstream end of the headcut and work upstream to the top. The butt ends of branches should be pointed downhill.
- 4) Cover the brush with a layer of large rocks, which will stabilize the mattress against the force of runoff. Use flat rocks where possible. Disturbed areas should be seeded and mulched (Figure VII-72).

**CALIFORNIA SALMONID STREAM
HABITAT RESTORATION MANUAL**

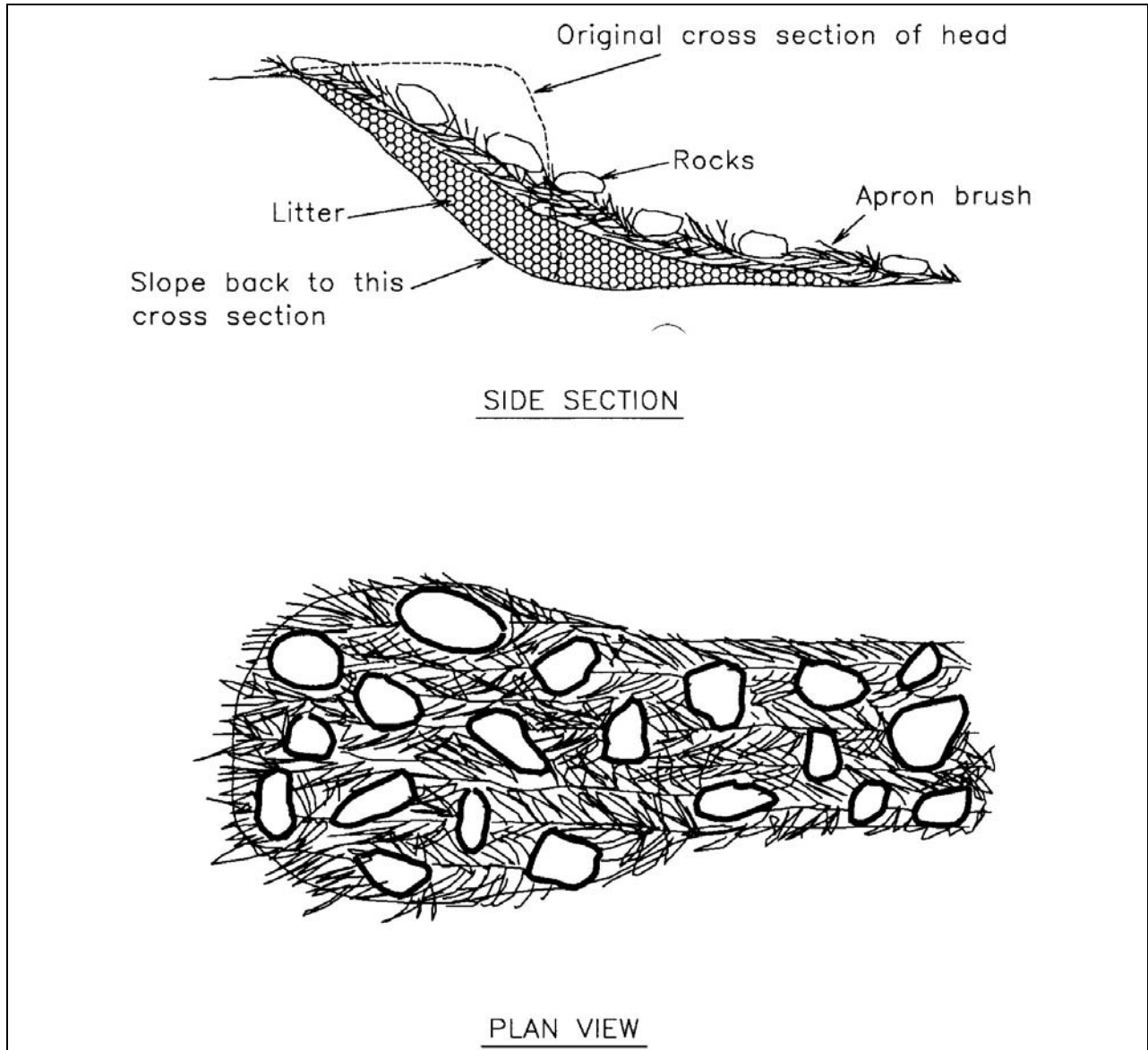

Figure VII-72. Brush and Rock Mattress (Kraebel and Pillsbury, 1934)

CALIFORNIA SALMONID STREAM HABITAT RESTORATION MANUAL

Waterbars

Waterbars (Figure VII-73) are a temporary means of breaking surface flow over sloped sections of road. They can be constructed with hand tools or heavy equipment. Waterbars are extremely effective at preventing rilling. They consist of a shallow ditch and rounded berm placed diagonally across the road surface. Often, they must be reconstructed every year because they either wear down during summer or are so annoying to those who regularly use the road that they are graded out in spring.

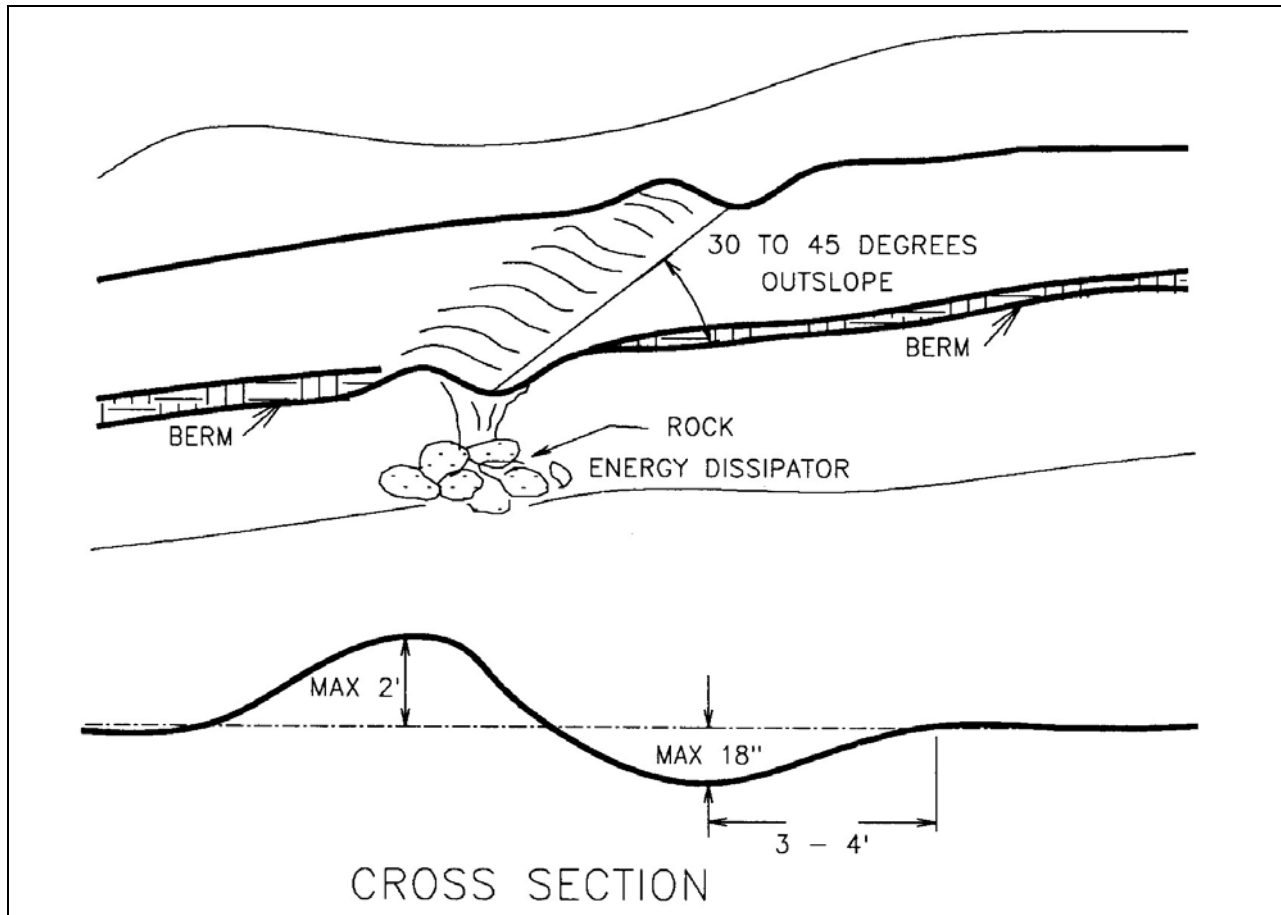

Figure VII-73. Waterbar.

Waterbars can be made easier to drive over by increasing the width and thereby reducing the slope of both the ditch and the berm. Installing waterbars in series will reduce the flow volume and hence the cutting action at each individual waterbar. Generally waterbars are spaced by dividing the road grade into 1000 feet. For example, if road grade is five percent, waterbars should be spaced approximately every 200 feet.

Waterbars can be reinforced with logs, gravel, or concrete. The outlet of the waterbar should open onto a wooded slope, existing stable channel, or onto a resistant slope that will not be adversely impacted by additional water. It may be necessary to create an energy dissipation mat by placing rocks or logs on the slope where water spills off the road.

CALIFORNIA SALMONID STREAM HABITAT RESTORATION MANUAL

Rolling dips function like waterbars when used as road cross drains. However, they do not require as much maintenance when properly installed, nor do they irritate motorists as much as waterbars. Rolling dips are installed by gradually ramping the road running surface down to a slightly outsloped low spot that is built across the roadbed, and then gradually ramping back up to the road grade. These installations often extend for a hundred feet or more. The low spot need only be about 12 inches below road grade in most installations. Site selection for rolling dips is similar to that used with waterbars.

Exclusionary Fencing

Streams passing through agricultural land are often adversely affected by livestock. Livestock can break down stream banks, destroy riparian vegetation, and by constant browsing, prevent new vegetation from becoming established. Overgrazed stream banks are highly susceptible to erosion and can add a significant amount of fine sediment to a stream. The best way to protect the riparian corridor and water quality of the stream is to exclude livestock access to the stream. This can be achieved by fencing the stream and riparian zone.

Generally, cattle require access to water every 1/4 mile. If livestock access to the stream for water is the only alternative, access points can be provided in areas with hard substrate where the stock will have the least effect on stream habitat. In most cases this will require fencing to cross the creek. In some instances, it may be more useful to develop an off stream water supply for livestock. There are also grazing rotation schemes that can alleviate effects to streams and riparian zones. The NRCS is a good source for further information on rotational grazing plans.

If exclusionary fencing is selected as a project, the DFG District Wildlife Biologist should be consulted prior to construction to make certain the location and type of fence will not be detrimental to wildlife in the area. Exclusionary fencing is constructed approximately parallel to the stream channel to keep livestock out of the stream and riparian zone. A setback of at least 25 feet from the stream bank should be used to establish an effective riparian zone.

Many types of fencing can be used. High-tensile wire fencing is probably the quickest and most economical to install. Electrical fencing can be economical to install but may require frequent maintenance. Barbed-wire, woven wire, wooden fence, or solid walls are more expensive to install. Regardless of the type of fence constructed, there will be an ongoing need for periodic maintenance.

Four or five strands of wire are usually necessary for permanent installations. To allow for wildlife passage the bottom wire is placed 18 inches from the ground. Redwood, cedar, yew, black locust, or pressure-treated posts are recommended for the wooden brace posts and corners.

A description of the construction of the many different types of fencing is beyond the scope of this manual. DFG's *A Gardener's Guide to Preventing Deer Damage* is a good reference on costs and designs used (Coey, 1994). NRCS is also a good source of information on fencing and improving grazing practices in watercourse areas. Many alternatives exist which have benefits to both stream channels and livestock production.

CALIFORNIA SALMONID STREAM HABITAT RESTORATION MANUAL

REFERENCES

- Anderson, John W. 1988. Design and location of instream structures. Stream Restoration Manual, Oregon Chapter American Fisheries Society, Ashland, Oregon, USA.
- Barnes, H.H., Jr. 1967. Roughness Characteristics Of Natural Channels. United States Geological Survey Water Supply Paper 1849.
- Beesey, Bob. 1988. Considerations for using selected materials for stream habitat enhancement. Stream Rehabilitation Manual, Oregon Chapter American Fisheries Society, Ashland, Oregon, USA.
- Bell, Milo C. 1986. Fisheries handbook of engineering requirements and biological criteria. U.S. Army Corps of Engineers.
- Blodgett, J.C. and C.E. McConaughy. 1986. Rock riprap design for protection of stream channels near highway structures. Volume 2. Evaluation of riprap design procedures. U.S. Geological Survey. Water Resources Investigations Report 86-4128. Sacramento, California, USA.
- Bray, D.I. 1982. Regime equations for gravel-bed rivers. Pages 517-542 in *Gravel-Bed Rivers*, ed. by R.D. Hey, J.C. Bathurst and C.R. Thorne, John Wiley and Sons, Chichester.
- British Columbia Ministry of Environment. 1980. Stream enhancement guide. British Columbia Ministry of Environment, Fish and Oceans.
- California Department of Forestry and Fire Protection. 1988. CDF guide to planting seedlings. Are you properly prepared for planting? Item # 48-69.
- Chow, V.T. 1959. Open Channel Hydraulics. McGraw-Hill Book Co., New York, 680 pp.
- Coey, R. and K. Mayer. 1994. A gardener's guide to preventing deer damage. California Department of Fish and Game, Sacramento.
- Crispin, Val. 1988. Main channel structures. Stream Rehabilitation Manual, Oregon Chapter American Fisheries Society, Ashland, Oregon, USA.
- Dunne, T. and L.B. Leopold. 1978. Water In Environmental Planning. W.H. Freeman and Company, New York, 877 pp.
- Dury, G.H. 1973. Magnitude-frequency analysis and channel morphometry, in *Fluvial Geomorphology*, State University of New York, Binghamton, Publications in Geomorphology, ed. by M. Morisawa, pp. 91-121.
- Evans, Willis A. and Johnson Beryl. 1980. Fish migration and fish passage, a practical guide to solving fish passage problems. USDA Forest Service.

CALIFORNIA SALMONID STREAM HABITAT RESTORATION MANUAL

- Fuller, David D. 1990. "R-5's Fish Habitat Relationship Technical Bulletin", Number 3, U.S. Department of Agriculture, Forest Service, Pacific Southwest Region.
- Graf, W.H. 1971. *Hydraulics Of Sediment Transport*. McGraw-Hill Book Co., New York, 513 pp.
- Hampton, Mark. 1989. Considerations for analysis of factors limiting salmonid populations. Proceedings of the Seventh California Salmon, Steelhead, and Trout Restoration Conference. Eureka, California, USA.
- Heede, Burchard H. 1976. Gully development and control, the status of our knowledge. U.S. Department of Agriculture, Forest Service Research Paper RM-169, Rocky Mountain Forest and Range Experiment Station, Fort Collins, Colorado.
- Henderson, J. E. and F. D. Shields, Jr. 1984. Environmental features for stream bank protection projects. Department of the Army, U.S. Army Corps of Engineers. Washington, DC., USA.
- Hey, R.D. 1982. Design equations for mobile gravel-bed rivers. Pages 553-574 in *Gravel-Bed Rivers*, ed. by R.D. Hey, J.C. Batherst, and C.R. Thorne, John Wiley and Sons, Chichester.
- House, Robert A. and P.L. Boehne. 1985. Evaluation of instream enhancement structures for salmonid spawning and rearing in a coastal Oregon stream. *North American Journal of Fisheries Management* 5: 283-295.
- Inter-Fluve, Inc. 1984. In-house computer design program for in-channel modifications. Inter-Fluve, Inc. Bozeman, MT.
- Jackson, W.L. and B.P. Van Haveren. 1984. Design for a stable channel in coarse alluvium for riparian zone restoration. *Water Resources Bulletin*, 20: 695-703.
- Jarrett, R.D. 1985. Determination Of Roughness Coefficients For Streams In Colorado. USGS Water Resources Investigation Report 85-4004, 54 pp.
- Johnson, Steve. 1990. Habitat improvement projects - how well do they work? *The STEP Volunteer*. Volume 7, Number 1.
- Koonce, Gregory P. 1990. Two-Pin Method for the Layout of Stream Habitat Enhancement Designs. Proceedings of the Eighth Annual California Salmon, Steelhead and Trout Restoration Conference. Eureka, California.
- Kraebel, Charles J. and Arthur F. Pillsbury. 1934. *Handbook of erosion control in mountain meadows*. U.S. Department of Agriculture, Forest Service, California Forest and Range Experiment Station, Berkeley, California.

CALIFORNIA SALMONID STREAM HABITAT RESTORATION MANUAL

- Ligon, Frank and W. Trush. 1989. A scientific agenda for restoration. Proceedings of the Seventh California Salmon, Steelhead and Trout Restoration Conference. Eureka, CA.
- Lisle, Tom and K. Overton. 1988. Utilizing channel information to reduce risk in developing habitat restoration projects. Stream Rehabilitation Manual, Oregon Chapter American Fisheries Society, Ashland, Oregon, USA. 10, 1988.
- McCain, Mike, D. Fuller, L. Decker, and K. Overton. "R-5's Fish Habitat Relationships Technical Bulletin", Number One, U.S. Department of Agriculture, Forest Service, Pacific Southwest Region.
- Miller, Dale E., R. J. O'Brien, and G. P. Koonce. 1988. Two-Pin Method for the Implementation of Instream Habitat Enhancement Designs. Presented at the 1988 Fisheries Bioengineering Symposium in Portland, Oregon, USA.
- Mott, R.L. 1979. Applied Fluid Mechanics. Charles Merrill Publishing Company, Columbus, Ohio, 405 pp.
- Overton, Kerry. 1987. Willow Creek project designs. Six Rivers National Forest, Arcata, California. Unpublished contract blueprints and personal communication.
- Paquet, Gilles. 1986. Guidelines for the improvement and restoration of the fish habitat in small streams. Service Des Etudes Ecologiques. Quebec, Canada.
- Platts, W.S., D. Armour, G.D. Booth, M. Gryant, J.L. Bufford, P. Cuplin, S. Jensen, G. W. Lienkaemper, G.W. Minshall, S.B. Monsen, R.L. Nelson, J.R. Sedell, and J.S. Tuhy. 1987. Methods For Evaluating Riparian Habitats With Applications To Management. United States Department of Agriculture, Forest Service General Technology Report INT 221.
- Prunuske, L.. 1987. Groundwork, a handbook for erosion control in north coastal California. Marin County Resource Conservation District.
- Rosgen, D.L., and B.L. Fittante. 1986. Fish habitat structures - a selection guide using stream classification. Pages 163-179 in J. G. Miller, J. A. Arway and R. F. Carline, eds. The 5th trout stream habitat improvement workshop.
- Rosgen, D.L. 1993. Applied fluvial geomorphology, training manual. River Short Course, Wildland Hydrology Consultants, Pagosa Springs, Colorado.
- Rundquist, L.A., N.E. Bradley, J.E. Baldrige, P.D. Hampton, T.R. Jennings and M.R. Joyce. 1986. Best Management Practices For Placer Mining, Reference Manual and Technical Report. Entrix, Inc., for Alaska Department of Fish and Game, 459 pp.
- Schiechtl, Hugo. 1980. Bioengineering for land reclamation and conservation. The University of Alberta Press.

CALIFORNIA SALMONID STREAM HABITAT RESTORATION MANUAL

State of California, Department of Transportation. 1970. Bank and Shore Protection in California Highway Practice. Sacramento, CA, USA.

United States Army Corps of Engineers. 1970. Hydraulic Design Of Flood Control Channels. EM 1110-2-1601.

University of California. 1978. Planting California forest land. Division of Agricultural Sciences. Leaflet 2925.

Williams, G.P. 1986. River meanders and channel size. *Journal of Hydrology*, 88: 147-164.

Wolman, M.G. and J.P. Miller. 1960. Magnitude and frequency of forces in geomorphic processes. *Journal of Geology*, 68: 54-74.

Wolman, M.G. and L.B. Leopold. 1957. River Floodplains: Some Observations On Their Formation. United States Geological Survey Professional Paper 282C.

Yu, B. and M.G. Wolman. 1987. Some dynamic aspects of river geometry. *Water Resources Research*, 23: 501-509.

**CALIFORNIA SALMONID STREAM
HABITAT RESTORATION MANUAL**

PART VIII

PROJECT EVALUATION AND MONITORING

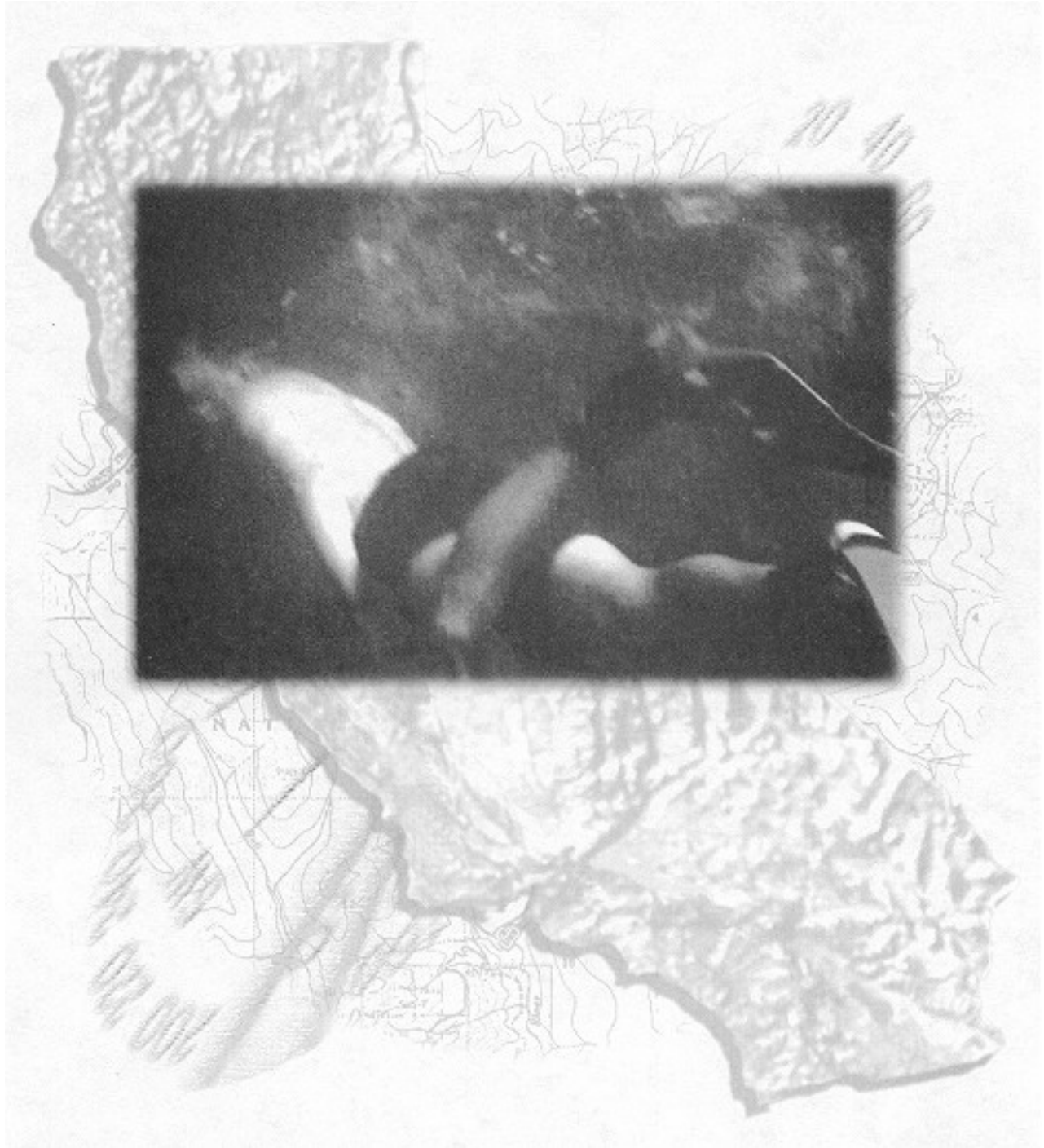

CALIFORNIA SALMONID STREAM HABITAT RESTORATION MANUAL

PART VIII PROJECT EVALUATION AND MONITORING

Habitat projects are designed and implemented with specific goals and objectives for restoring, improving, enhancing or maintaining stream habitat conditions. Through the process of evaluating and monitoring habitat projects, it can be determined if intended goals have been achieved.

Evaluation is generally a comparison between conditions before and after a project that quantitatively or qualitatively measures the change. Factors to be considered during an evaluation should include both physical and biological conditions. An evaluation provides information regarding the level of success or failure of prescriptions and techniques and guidance for future designs and construction techniques. It provides the fishery manager and habitat specialist with specific data regarding habitat improvement prescriptions that have proven to result in positive responses. It also provides contract administrators and landowners with cost-benefit information and a basis for future project funding consideration.

Monitoring, although similar in many respects to evaluation, generally involves documenting specific conditions that may or may not specifically have been objectives of the project. For example, permits or environmental review processes may require monitoring for overall or specific "environmental impacts." This monitoring will be for a specific and usually extended time period and may involve sensitive plant and animal species or communities. On site or off site monitoring can be part of an investigation process to measure the effectiveness of required mitigation efforts as a result of a project's impacts.

The evaluation process begins well before project construction or implementation. The early stages of project planning should include an investigation of the status of the target species and associated habitat. In most cases, general status of communities, species, or habitat provides the impetus for restoration or enhancement plans. The foundation for evaluation should include specific biological and physical details that describe the historic and pre-project features of the proposed project site and watershed.

Knowledge of fish species abundance and habitat conditions that existed during the early period of European arrival can provide historic information necessary to define optimum goals and objectives. However, caution should be exercised to ensure project goals are realistic within the parameters of the project. In many cases, restoration of historic conditions or fish populations are no longer possible due to severe environmental modifications like dams, water diversions, soil and vegetation disturbance, or changes in species composition of the biotic community. If project goals established during the planning process are not realistic, it's unlikely the goals will be reached and the evaluation will reveal failure.

CALIFORNIA SALMONID STREAM HABITAT RESTORATION MANUAL

Pre-Project Assessment and Data Collection

Historic Information

Historic watershed, stream channel, riparian, fish and wildlife, and land use information describes potential capabilities and establishes targets for planning purposes. Historic information also aids in the evaluation process by providing a greater understanding of what to expect from habitat restoration or enhancement efforts. Historic data should provide descriptions in the following areas:

- Aquatic species, abundance indices, distribution;
- Riparian community species and densities;
- General watershed condition and uses;
- Channel and habitat types;
- Instream sediment storage and transport;
- Stream flow and water temperature regimes.

Pre-Project Information

Existing or pre-project descriptions of habitat and channel types, fish species, riparian communities, and water quality are vital for the evaluation process. Pre-project data provides the benchmark for comparing project effects. Without pre-project data the post-project field investigations become merely an inventory or exercise in collecting baseline data with no basis for comparison. Pre-project data categories should include:

- Existing aquatic species, abundance indices, age structure, and distribution;
- Existing channel and habitat types throughout the proposed project reach;
- Existing spawning substrate availability and fine sediment composition;
- Existing water quality and flow and temperature regimes;
- Existing riparian species and densities;
- Existing watershed conditions and uses;
- Photographs of specific proposed project sites.

CALIFORNIA SALMONID STREAM HABITAT RESTORATION MANUAL

Documentation Immediately Following Project Completion

Completed projects should include an overall description of actual work accomplished and should include the following information:

- Specific location of the stream reach receiving structure(s) or prescription as defined by a permanently marked surveyed and geo-referenced location (i.e., reference point), and a distance measurement and direction from the referenced point (e.g., bridge, building or stream mouth) to the beginning of the treatment reach, and the stream length of the project reach. The number of structures built should also be given;
- "As-built" descriptions, design drawings, and photographs should be provided whenever possible;
- Description of the habitat associated with each structure or prescription including habitat unit number, habitat type, pool depth, pre-scour depth, spawning gravel abundance and quality, shelter rating, and fish presence. This information can be recorded on the Habitat Inventory Data Form in Part III;
- Objectives of the structure(s) or prescription;
- Riparian enhancement projects should append written descriptions, photo documentation, and plant species surveys of the site immediately before and after planting;
- Cost of each prescription or total project cost within a contiguous reach (especially important if a contract includes multiple projects or streams).

Completed project descriptions should include information to enable a person to: 1) locate a specific project reach where structures were built or prescription applied years after project completion; 2) discern how the original project was constructed and configured; and 3) determine what the objectives of the project were and ascertain the result. For example, if a pool-forming or scour structures were constructed, water depth within the anticipated scour area of each habitat unit or type needs to be documented at time of completion if a measure of how much the structure contributed to pool depth is to be obtained during subsequent evaluations.

To ensure that appropriate background, location, and type of structure information is recorded, a "Project Site Completion Form" should be completed for each newly completed structure or project reach. Subsequent evaluations should use the "General Project Information Form," to provide an overview of the project evaluation, and the "Individual Structure or Site Form" to record the assessment of each individual structure or prescription contained in the Project. For projects administered or conducted by DFG and completed in northern and central California, and for which a USCOE General Permit No. 22323N was issued, a "Project Site Completion Form" **must** be filled out and submitted to DFG immediately upon completion of the project. The "Project

CALIFORNIA SALMONID STREAM HABITAT RESTORATION MANUAL

Site Completion Form” should be prepared as soon as possible upon project completion. Send it, along with any accompanying Habitat Inventory Data Forms to:

California Department of Fish and Game
Inland Fisheries Division
610 9th Street
Fortuna, CA 95540
Attention: Salmonid Habitat Improvement Project Evaluator
(707) 725-0976.

Instructions for Completing the Project Site Completion Form

- 1) **Stream** - Name of stream where project is located.
- 2) **Date** - Date the form was completed.
- 3) **Page __ of __** - Number the page. For example, if this is page 5 out of 11 total pages for project site evaluation in stream XYZ then indicate: Page 05 of 11.
- 4) **Contractor/Organization** - Name of individual contractor, firm or agency performing work.
- 5) **Inspector** - Name of person preparing this form.
- 6) **Contract No.** - This number should be a DFG or WCB contract number or a Region project identifier code.
- 7) **FY** - Fiscal year of contract (e.g., "97/98").
- 8) **Landowner** - Owner and contact person for access permission.
- 9) **Estimated Cost** - If this is a "multiple site" contract, determine the portion of dollars of the total contract spent within the stream reach or area being treated.
- 10) **Length of Project/Numbers of Structures** - Enter the total stream length in feet treated and the number of structures constructed.
- 11) **Reference Point** - The point from which each structure location is measured. This point should be a prominent feature that is easily recognizable and will not change over time. Examples include bridges, mouths of tributaries, survey marker, and buildings. Do not use trees, boulders, etc.

CALIFORNIA SALMONID STREAM HABITAT RESTORATION MANUAL

- 12) **Lat and Long** - Latitude and longitude of reference point.
- 13) **Feet From Reference Point UP or DN** - Indicate feet from the reference point and check the appropriate box (UP or DN) to show if the measurement is upstream or downstream of reference point. In most cases a "hip chain" should be used.
- 14) **Channel Type** - Indicate channel type according to Rosgen's system (Part III).
- 15) **Constructed Using** - Check the appropriate box indicating the type of construction technique use; Hand Crew, Heavy Equipment, or Both.
- 16) **Project Objective** - Check the appropriate box indicating the objective of the project; Instream Habitat Improvement, Erosion Control, or Fish Passage.
- 17) **Type of Structure** - This is a 3 digit numeric code. Refer to the structure type code list at the end of these instructions.
- 18) **Project Completion Check Points** - Check the appropriate box (YES or NO) indicating the answer to the following questions. If the answer is no, provide an explanation for the deviation.
 1. Project techniques according to manual
 2. Materials of recommended type and size
 3. Structure positioned correctly to meet objectives
 4. Followed permit(s) specifications
 5. Landowner(s) agreed with work and materials used
- 19) **Original Habitat Type** - Use fish habitat type alpha abbreviations (Part III) to describe the habitat originally present before construction or treatment.
- 20) **Target Habitat Type** - Use habitat type alpha abbreviations (Part III) to describe the habitat the structure was intended to create.
- 21) **Habitat Maximum Depth** - Record the maximum depth found in the habitat unit.
- 22) **Bankfull Stream Width** - Record the bankfull stream width near the structure at the nearest velocity crossover point.
- 23) **Comments** - Include any comments or overall project assessment.
- 24) **If Revegetation** - Check the appropriate box indicating the location of the revegetation project; Riparian, Upslope, or Both.

CALIFORNIA SALMONID STREAM HABITAT RESTORATION MANUAL

- 25) **Describe Density or Coverage** - Enter the area of revegetation. Indicate species planted, average height, and average density. For example: alders, height 4', density, 2 per sq. yd. For mature projects or exclusion fencing projects density can be described as sparse, moderate, or very dense. Attempt to identify dominant plant species. Photos should be taken of all revegetation projects.
- 26) **Photographs** - Check the appropriate box indicating if photographs of the project were taken. If yes, enter the location where the photographs are stored.

PROJECT SITE COMPLETION FORM

Stream: _____ **Date:** _____ **Page** _____ **of** _____

Contractor/Organization: _____

Inspector: _____ **Contract No.:** _____ **FY:** ____/____

Landowner: _____

Estimated Cost: _____

Length of Project/Numbers of Structures: _____

Reference Point: _____ **Lat:** _____ **Long:** _____

Feet From Reference Point: _____ UP / DN **Channel Type:** _____

Constructed Using: Hand Crew Heavy Equipment Both

Project Objective: Instream Habitat Erosion Control Fish Passage

Type of structure: _____

Project Completion Check Points:	YES	NO	
1. Project techniques according to manual	<input type="checkbox"/>	<input type="checkbox"/>	If no, explain: _____ _____
2. Materials of recommended type and size	<input type="checkbox"/>	<input type="checkbox"/>	If no, explain: _____ _____
3. Structure positioned correctly to meet objectives	<input type="checkbox"/>	<input type="checkbox"/>	If no, explain: _____ _____
4. Followed permit(s) specifications	<input type="checkbox"/>	<input type="checkbox"/>	If no, explain: _____ _____
5. Landowner(s) agreed with work and materials used	<input type="checkbox"/>	<input type="checkbox"/>	If no, explain: _____ _____

Original Habitat Type: _____ **Target Habitat Type:** _____

Habitat Maximum Depth: _____ **ft.** **Bankfull Stream Width:** _____ **ft.**

Comments: _____

If Revegetation: Riparian Upslope Both (photo required for revegetation.)

Describe Density or Coverage: _____

Photographs: Yes No If yes, location of photographs: _____

CALIFORNIA SALMONID STREAM HABITAT RESTORATION MANUAL

Post-Project Evaluation

Post-project evaluation should be performed by an independent person or group. Having no prior connection to the project increases the potential for an objective and credible evaluation. Initial post-project evaluation should occur within one to three years after project completion. The project should have endured at least one, but not more than three, winter's high flow in order to detect and correct situations requiring modification or maintenance. Post-project evaluation considers both physical and biological aspects similar to those categories suggested for pre-project data collection. Physical features associated with a project are generally more easily measured, interpreted, and compared when both pre- and post-project data are available. Habitat quality can be assessed using physical features and biological parameters other than fish data (e.g., vegetation and/or invertebrate communities). Biological data, especially anadromous fish data, are more difficult to collect and interpret. Reliable correlations of anadromous salmonid population responses to habitat improvement prescriptions generally requires many years of trend data.

Habitat Project Evaluation Forms

Standard forms have been developed for evaluating existing habitat improvement projects. The evaluation reviews and documents the physical effectiveness of individual habitat enhancement manipulations. These include stream habitat structures, fish passage modifications, riparian vegetation enhancements, erosion control and stream bank stability improvements. Each structure or habitat prescription site is to be evaluated according to the questions asked on the evaluation forms. To eliminate entering repetitive background information on each field form, two forms have been designed:

1. General Project Information Form.
2. Individual Structure or Site Form.

The "General Project Information Form" provides background information pertaining to the entire project or contract. Much of the information concerning project design and objectives, and pre-project data is held by contract administrators or original project proponents. This form will assist in identifying what background information is available and its location. This form also serves to summarize pertinent stream information necessary for completion of the evaluation process. Completion of the "General Project Information Form" should occur prior to commencing field evaluations of individual structures.

The "Individual Structure or Site Form" is for field use. Key stream and project background information has been abbreviated to serve as a cross reference to the "General Project Information Form."

Evaluations should be completed by evaluation project personnel or selected individuals familiar with habitat restoration projects. Evaluations of projects lacking documentation of specific features should be conducted with the assistance of the appropriate individual having first-hand knowledge of project details. Project contractors or contract administrators are not to evaluate their own projects, however, they may be consulted regarding project details and site

CALIFORNIA SALMONID STREAM HABITAT RESTORATION MANUAL

locations. Contract administrators must complete the "Project Site Completion Form" immediately after project completion for background information purposes.

After completing a project evaluation, send the original completed forms and any electronic data and photos to the DFG address listed below. Label all photos with the stream, date, corresponding evaluation form page number, structure type and location in feet from the reference point.

Any questions concerning this evaluation procedure should be directed to:

California Department of Fish and Game
Inland Fisheries Division
610 9th Street
Fortuna, CA 95540
Attention: Salmonid Habitat Improvement Project Evaluator
(707) 725-0976.

Equipment

The following equipment is necessary to conduct evaluations:

- Hip boots or chest waders with non-skid devices
- Hip chain (a reel tape or drag tape could be used)
- Stadia rod or other water depth measuring device
- Clipboard and pencils
- Evaluation forms (on waterproof paper) and code lists
- Project documents including site maps and structure designs
- Camera and film
- Handheld tape recorder (optional)

Instructions for Completing the General Project Information Form

- 1) **Stream** - Name of stream where project is located.
- 2) **Watershed** - Name of watershed system that stream is a component.
- 3) **Evaluator** - Name of individuals conducting evaluation.
- 4) **Date** - Date of field evaluation.
- 5) **Contract No.** - This number should be a DFG or WCB contract number or a Region project identifier code.
- 6) **FY** - Fiscal year of contract (e.g. "96/97").
- 7) **Fund Source** - Include if known.

CALIFORNIA SALMONID STREAM HABITAT RESTORATION MANUAL

- 8) **DFG Contact** - DFG staff knowledgeable about contract, usually the contract administrator.
- 9) **Contractor** - Name of individual contractor, firm, or agency performing work.
- 10) **Does Contract Include Other Streams or Locations** - Indicate if this is a "multiple site" contract. If it is, the next question asks you to determine the portion of dollars of the total contract spent within the stream reach being evaluated.
- 11) **Property Owner** - Owner and contact person for access permission.
- 12) **Access Directions** - Specific directions to the project site.
- 13) **Channel Type** - Use the Rosgen system outlined in this manual (Part III).
- 14) **Stream Order** - Determined by using method on Page II-3 of this manual.
- 15) **Drainage Area** - Enter the drainage area for the entire stream where the project is located. Leave blank if project is not instream.
- 16) **USGS Quad** - Name of 7.5-minute USGS quadrangle map(s).
- 17) **Project Location at Downstream End** - Determine the latitude and longitude of the most downstream end of the project. This is accomplished using a USGS Quadrangle and a Coordinator, or a GPS unit, if available (Appendix M).
- 18) **Date Project Completed** - Enter the month and year of project completion.
- 19) **Date of Last Evaluation** - Enter date of last documented evaluation similar to this method or latest habitat typing date.
- 20) **Pre-project Evaluation or Data** - Indicate the existence of electrofishing or carcass survey, habitat typing, stream survey, etc. data files or reports. If it exists, give its location.
- 21) **As-built or Project Designs** - Indicate if plans exist that define what was accomplished or designed to be accomplished for the project. Of particular concern is a sequence list or designs of structure types and their locations where actually constructed. Without this information it is difficult to determine where a structure was located and its original design configuration.
- 22) **Number of Structures Constructed** - Enter original number of structures known or documented as constructed.
- 23) **Number of Structures Evaluated** - Enter number of structures actually observed.
- 24) **Number of Evaluation Pages Associated With This Form** - Attach all related Individual Structure or Site Forms to the General Project Information Form and indicate the number

CALIFORNIA SALMONID STREAM HABITAT RESTORATION MANUAL

of forms attached. This information indicates how many field forms should be attached to this general form.

- 25) **General Project Evaluation or Comments** - Include any comments or overall project assessment. Indicate your judgement of habitat benefits on a project level. This is a summary statement of all observed structures and their collective effects.

STREAM HABITAT ENHANCEMENT PROJECT EVALUATION

GENERAL PROJECT INFORMATION FORM

STREAM: _____ WATERSHED: _____

EVALUATOR: _____ DATE: _____

CONTRACT NO.: _____ FY: ____/____ FUND SOURCE: _____

DFG CONTACT: _____ CONTRACTOR: _____

DOES THIS CONTRACT INCLUDE OTHER STREAMS OR LOCATIONS: Y ___ N ___

AMOUNT SPENT ON EVALUATED PORTION OF CONTRACT: \$ _____
(May include total contract amount or a portion of contract)

PROPERTY OWNER: _____

ACCESS DIRECTIONS: _____

CHANNEL TYPE(S): _____ STREAM ORDER: _____ DRAINAGE AREA (SQ MI): _____

USGS QUAD (7.5 MIN): _____

PROJECT LOCATION AT DOWNSTREAM END: LAT. _____ LONG. _____

DATE PROJECT COMPLETED: MONTH _____ YEAR _____

DATE OF LAST EVALUATION: MONTH _____ YEAR _____

PRE-PROJECT EVALUATION OR DATA AVAILABLE: Y ___ N ___ IF YES WHERE? _____

ARE AS-BUILT DATA OR PROPOSED DESIGNS AVAILABLE: Y ___ N ___ IF YES WHERE? _____

NO. OF STRUCTURES CONSTRUCTED: _____ NO. OF STRUCTURES EVALUATED: _____

COMMENTS: _____

NUMBER OF EVALUATION PAGES ASSOCIATED WITH THIS FORM: _____

GENERAL PROJECT EVALUATION OR COMMENTS: _____

CALIFORNIA SALMONID STREAM HABITAT RESTORATION MANUAL

Instructions for Completing the Individual Structure or Site Form

- 1) **Stream** - Name of stream where project is located.
- 2) **Watershed** - Name of watershed system that stream is a component.
- 3) **Page __ of __** - Number the page. For example, if this is page 5 out of 11 total pages for project site evaluation in stream XYZ then indicate: Page 05 of 11.
- 4) **Date** - Date of field evaluation.
- 5) **Stream PNAME** - The official stream name according to the reach file list
- 6) **PNAME Code** - The numeric code for the stream corresponding to the PNAME.
- 7) **Evaluator** - Name of person(s) performing evaluation.
- 8) **Contract No.** - Make certain this is same number as on the "General Project Information Form."
- 9) **FY** - Fiscal year of contract.
- 10) **Reference Point** - The point from which each structure location is measured. This point should be a prominent feature that is easily recognizable and will not change over time. Examples include bridges, mouths of tributaries, survey marker, and buildings. Do not use trees, boulders, etc.
- 11) **LAT and LONG** - Latitude and longitude of reference point in decimal degrees.
- 12) **Feet from Reference Point UP or DN** - Indicate feet from the reference point and circle appropriate UP or DN to show if the measurement is upstream or downstream of reference point. In most cases a "hip chain" should be used.
- 13) **Channel Type** - Indicate channel type according to Rosgen's system.
- 14) **Structure Objective** - Use one of the following numeric codes:
 1. Fish passage improvement
 2. Watershed and stream bank stability improvement
 3. Stream improvement of rearing and/or spawning habitat
- 15) **Type of Structure** - This is a 3 digit numeric code. Refer to the structure type code list at the end of these instructions.

CALIFORNIA SALMONID STREAM HABITAT RESTORATION MANUAL

16) **How Well Is Structure Meeting Habitat Objective -**

1. (Excellent) Structure is providing the habitat conditions as expected. Examples include: formation of a primary pool, spawning gravel retained, complex cover provided, sediment controlled, vigorous riparian growth achieved, etc.
2. (Good) Structure is meeting objectives and providing habitat but maximum pool depth is between 2.0 to 2.5 feet, shelter complexity is less than 3, spawning gravel is available but not abundant, or riparian growth is moderate.
3. (Fair) Structure is providing some habitat benefit that was not present before construction but it is achieving only partial expected benefits, or it may be providing some benefit but not the intended objective. Examples include: pool scour depth less than 2 feet, very little spawning gravel associated with structure, cover not complex, etc. Use comments section to explain.
4. (Poor) Very little habitat value exists as a result of the structure or prescription. Virtually no pool scour, shelter complexity less than 2, no gravel retained, etc. Use comments to explain.
5. (Failed) Not visible. No value. Structure is not meeting objective. Stranded out of stream channel with no possibility of providing low or high flow benefit. Use comments to explain.

17) **Condition of Structure -** Check appropriate item. Consider structure condition only. Do not include functional aspects in this category. The structure may not be functioning (stranded out of channel) but it may be in excellent structural condition.

1. (Excellent) Structure is intact and structurally sound.
2. (Good) Structure is intact and generally sound but some wear is evident. Pieces may have shifted slightly, erosion cloth visible, wire fence material visible, one or two anchor pins or cables loose but structure still intact. Structure is generally as designed. Use comments to explain.
3. (Fair) Structure has been altered significantly but is still meeting about 50 percent of design criteria. Boulders or logs may have shifted, log weirs undercut, cables loose, etc. Use comments to explain.
4. (Poor) Structure is visible but in a condition that is only about 25 percent of original design. Significant structural damage. Use comments to explain.

CALIFORNIA SALMONID STREAM HABITAT RESTORATION MANUAL

5. (Failed) Complete structural failure. Not visible or remnants not in any form of designed configuration. Use comments to explain.
- 18) **Structure Problems** - Check one or more of the appropriate items. Use comments if necessary.
- 19) **Repair or Modification Recommended** - Indicate if structure should be repaired or modified to improve effectiveness.
- 20) **Habitat Type Created** - Use fish habitat type alpha abbreviations (Part III) to describe the habitat created by the structure.
- 21) **Bankfull Stream Width** - Record the bankfull stream width near the structure at the nearest velocity crossover point.
- 22) **Maximum Pool Depth** - If structure is associated with a pool, record the maximum depth of pool.
- 23) **Depth of Pool Tail Crest** - If maximum depth of pool is recorded, also record depth of pool tail crest of pool.
- 24) **Instream Shelter Complexity** - For structures or treatments forming instream salmonid habitat determine the shelter complexity value using the following criteria:

Value	Instream Shelter Complexity Value Examples:
0	<ul style="list-style-type: none"> ● No shelter.
1	<ul style="list-style-type: none"> ● One to five boulders. ● Bare undercut bank or bedrock ledge. ● Single piece of large wood (>12" diameter and 6' long) defined as large woody debris (LWD).
2	<ul style="list-style-type: none"> ● One or two pieces of LWD associated with any amount of small wood (<12" diameter) defined as small woody debris (SWD). ● Six or more boulders per 50 feet. ● Stable undercut bank with root mass, and less than 12" undercut. ● A single root wad lacking complexity. ● Branches in or near the water. ● Limited submersed vegetative fish cover. ● Bubble curtain.

CALIFORNIA SALMONID STREAM HABITAT RESTORATION MANUAL

- 3 Combinations of (must have at least two cover types):
- LWD/boulders/root wads.
 - Three or more pieces of LWD combined with SWD.
 - Three or more boulders combined with LWD/SWD.
 - Bubble curtain combined with LWD or boulders.
 - Stable undercut bank with greater than 12" undercut, associated with root mass or LWD.
 - Extensive submersed vegetative fish cover.
- 25) **Instream Shelter Percent Cover** - Instream shelter percent cover is a measure of the area of the habitat unit that is occupied by instream shelter. The area is estimated from an overhead view.
- 26) **Shelter Rating** - Shelter rating is the product of multiplying shelter complexity times instream shelter percent cover.
- 27) **Observed Salmonids Number** - Enter the number of salmonids or redds observed within the habitat associated with the structure. Keep in mind that this observation must be made as you first approach the habitat unit. Use comments for species identification, if applicable. Differentiate juveniles by age class:
- 0+ less than about 3 inches in length,
- 1+ greater than 3 inches in length.
- 2+ greater than 6 inches in length
- 28) **Revegetation** - Check appropriate area of revegetation. Indicate species planted, average height, and average density. Example: alders, height 4', density 2 per sq. yd. For mature projects or exclusion fencing projects density can be described as sparse, moderate, or very dense. Attempt to identify dominant plant species. Photos should be taken of all revegetation projects.
- 29) **Photo No.** - Enter photo roll and frame number, if applicable. Submit labeled photos with field forms. Photos are highly encouraged of each structure or treatment.

**STREAM HABITAT ENHANCEMENT PROJECT EVALUATION
INDIVIDUAL STRUCTURE OR SITE FORM**

STREAM: _____ DRAINAGE: _____ PAGE _____ of _____

DATE: ____/____/____ STREAM PNAME: _____ PNAME CODE: _____

EVALUATOR(s): _____ CONTRACT NO.: _____ FY: ____/____

REFERENCE POINT: _____ LAT: _____ LONG: _____
(DECIMAL DEGREES) (DECIMAL DEGREES)

FEET FROM REFERENCE POINT: _____ UP DN CHANNEL TYPE: _____

RESTORATION OBJECTIVE: 1 2 3 TYPE OF STRUCTURE: _____

HOW WELL IS STRUCTURE MEETING HABITAT OBJECTIVE? (circle number)

1 (EXCELLENT) _____ **2 (GOOD)** _____ **3 (FAIR)** _____ **4 (POOR)** _____ **5 (NO VALUE)** _____

COMMENTS: _____

CONDITION OF STRUCTURE - consider structural integrity only (circle number):

1 (EXCELLENT) _____ **2 (GOOD)** _____ **3 (FAIR)** _____ **4 (POOR)** _____ **5 (NO VALUE)** _____

COMMENTS: _____

STRUCTURE PROBLEMS (check appropriate items):

- | | |
|--|---|
| 1. <input type="checkbox"/> ANCHOR FAILURE, | 8. <input type="checkbox"/> LOGS/BOULDERS STRANDED OUT OF CHANNEL, |
| 2. <input type="checkbox"/> CABLE FAILURE, | 9. <input type="checkbox"/> BANK EROSION AT SITE AND/OR DOWNSTREAM, |
| 3. <input type="checkbox"/> CHANNEL SHIFT, | 10. <input type="checkbox"/> CREATED SEDIMENT TRAP, |
| 4. <input type="checkbox"/> BOULDER/LOG SHIFT, | 11. <input type="checkbox"/> POOR DESIGN, |
| 5. <input type="checkbox"/> UNDERMINED, | 12. <input type="checkbox"/> POOR PLACEMENT, |
| 6. <input type="checkbox"/> BURIED BY BEDLOAD, | 13. <input type="checkbox"/> EX-FENCE FAILURE, |
| 7. <input type="checkbox"/> UNDERBUILT, | 14. <input type="checkbox"/> OTHER. |

COMMENTS: _____

Repair recommended: Yes No Enhancement to improve cover or effectiveness recommended: Yes No

HABITAT TYPE (associated with structure) _____ BANKFULL STREAM WIDTH _____ FT.

MAXIMUM POOL DEPTH _____ FT. DEPTH OF POOL TAIL CREST _____ FT.

SHELTER COMPLEXITY: 0 1 2 3 × SHELTER % COVER: _____ = SHELTER RATING: _____

OBSERVED SALMONIDS NO.: 0+ _____, 1+ _____, 2+ _____, ADULTS _____, REDDS _____

COMMENTS: _____

REVEGETATION: RIPARIAN ___ UPSLOPE ___ BOTH _____ (Photo required for reveg.) DESCRIBE DENSITY: _____

PHOTO NO. PRINT: ROLL _____ FRAME _____ SLIDE: ROLL _____ FRAME _____

COMMENTS: _____

CALIFORNIA SALMONID STREAM HABITAT RESTORATION MANUAL

Structure objective codes:

- 1 fish passage improvement
- 2 watershed and stream bank stability improvement
- 3 rearing and spawning stream channel improvement

Structure type codes:

- 100 Fish passage improvement (general)
 - 110 fishways - general
 - 111 step-and-pool
 - 112 Denil ladder
 - 113 Alaskan steeppass
 - 119 other
 - 120 culvert modification
 - 121 back-flooding weirs
 - 122 culvert baffles - general
 - 123 Washington baffles
 - 124 steel-ramp CMP baffles
 - 129 other
 - 130 natural barrier modification or removal
 - 131 log jam removal or modification
 - 132 beaver dam removal or modification
 - 133 waterfalls and chutes - blasting modifications
 - 134 landslide removal or modification
 - 139 other
 - 140 fish screens
- 200 Watershed and stream bank stability (general)
 - 210 stream bank stabilization structures - general
 - 211 boulder riprap or bank armor
 - 212 boulder wing-deflectors
 - 213 log cribbing
 - 214 log bank armor
 - 215 log wing-deflector
 - 216 boulder/log deflector

CALIFORNIA SALMONID STREAM HABITAT RESTORATION MANUAL

- 217 tree revetment
- 218 gabions
- 219 other

- 220 mulching

- 230 revegetation

- 240 exclusion fencing

- 250 checkdams
 - 251 redwood board checkdam
 - 252 brush and rock checkdam
 - 253 post brush checkdam
 - 254 tree checkdam
 - 255 brush and rock mattress

- 260 waterbars

- 270 bioengineering
 - 271 live vegetative crib wall
 - 272 native material revetment
 - 273 willow wall revetment
 - 274 brush mattress
 - 275 willow siltation baffles

- 299 other

- 300 Stream channel improvement (general)
 - 310 boulder weir
 - 311 boulder weir with sill log
 - 312 boulder cluster
 - 313 boulder wing-constrictor - single
 - 314 boulder wing-constrictor - opposing
 - 315 vortex boulder weir

 - 320 boulder/log combo constrictor - single

 - 325 boulder/log combo constrictor - opposing

 - 330 log weir (plunge)
 - 331 log wing-constrictor - single
 - 332 log wing-constrictor - opposing

**CALIFORNIA SALMONID STREAM
HABITAT RESTORATION MANUAL**

- 333 digger/cover log (vertical)
- 334 divide log
- 335 spider logs or cover log complex
- 336 Hewitt ramp
- 337 upsurge log weir

- 340 cover root wads
 - 341 cover logs (horizontal)
 - 342 cover boulders (edge cover)
 - 343 boulder cluster with woody cover (root wads or logs)
 - 344 unanchored large woody debris

- 350 gabion weir
 - 351 gabion wing-constrictor - single
 - 352 gabion wing-constrictor - opposing
 - 353 boulder cluster field - >5 clusters spaced 20-30 ft. apart
 - 354 log/gabion constrictor - single
 - 355 log/gabion constrictor - double

Construction method codes:

- 1 hand crew
- 2 heavy equipment

CALIFORNIA SALMONID STREAM HABITAT RESTORATION MANUAL

SUMMARY

Project evaluation should be considered an important element in the project development and implementation process. The evaluation process provides a measure of the benefits and provides insight and guidance for future projects.

Although post-project evaluation is intended to be performed by individuals other than project contractors or contract administrators, it is essential that those individuals involved with project planning and implementation are aware of the data and documentation needs of the evaluator.

The evaluation process begins in the early planning stages with documentation of historical and existing pre-project conditions. A well documented description of species composition, distribution, adult and juvenile abundance, habitat type and quality, channel types, summer and early-fall flow and temperature regimes, gravel quality, and general watershed characteristics should be available for future project evaluation.

Specific project structures or prescriptions should be described, diagramed and photographed to indicate location and structural specifics. The intended objective of each prescription should be indicated. Most habitat projects have an expected project-life exceeding 10 years. It is, therefore, essential to provide documentation and guideposts to enable workers in the following decades to locate, evaluate, and learn from projects completed today.

**CALIFORNIA SALMONID STREAM
HABITAT RESTORATION MANUAL**

APPENDICES

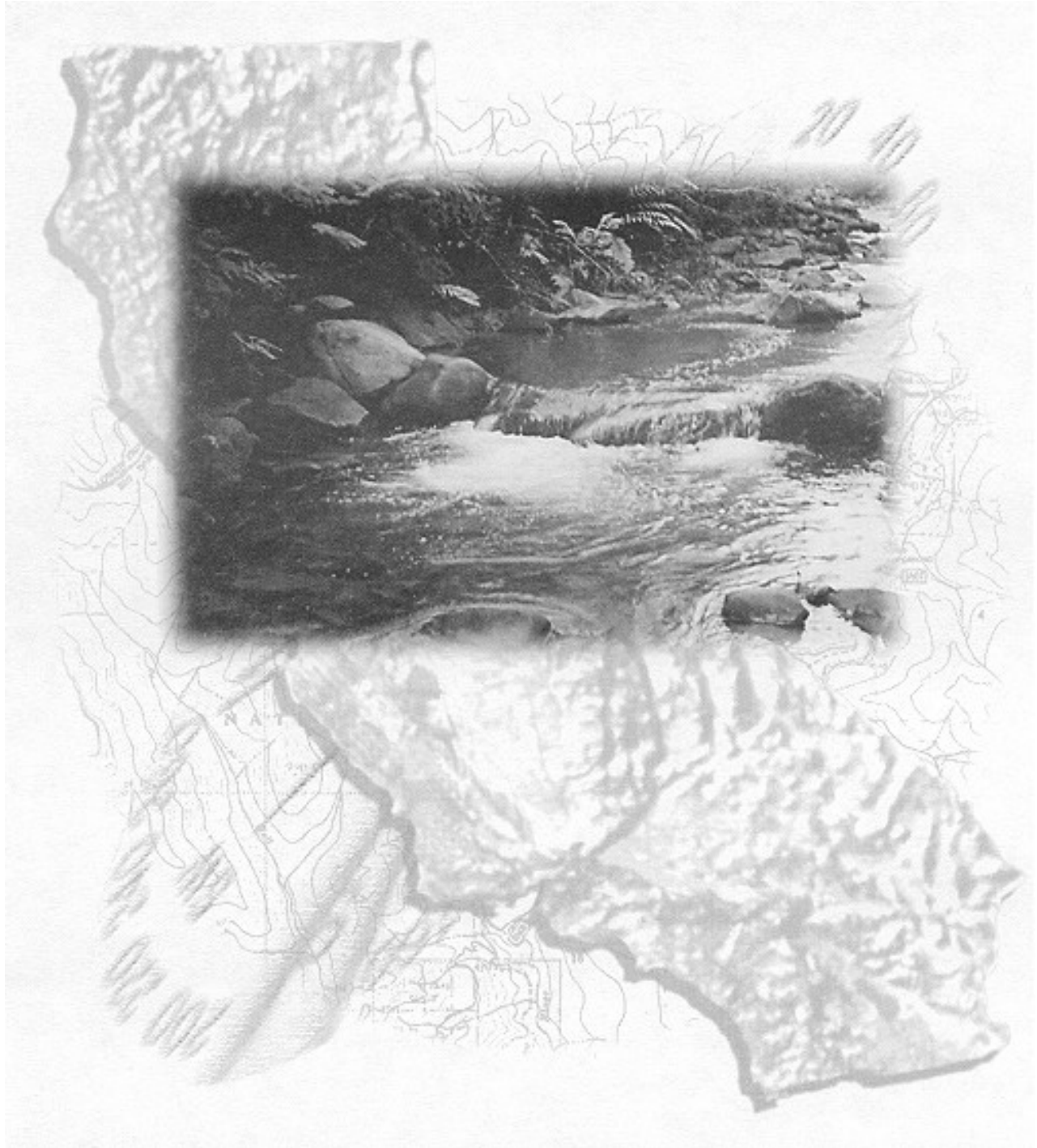

CALIFORNIA SALMONID STREAM HABITAT RESTORATION MANUAL

APPENDIX A.

POLICY AND REGULATIONS FOR SALMON AND STEELHEAD RESTORATION IN CALIFORNIA

FISH AND GAME COMMISSION POLICY

Steelhead Rainbow Trout

It is the policy of the Fish and Game Commission that:

- I. Steelhead rainbow trout shall be managed to protect and maintain the populations and genetic integrity of all identifiable stocks. Naturally spawned steelhead shall provide the foundation of the Department's management program.
- II. Steelhead shall be rescued only when they will be returned to the stream system of origin. Rescue of juvenile steelhead shall be limited to circumstances where fish can be held until habitat conditions improve, or where immediate release can be made in understocked areas of their natal stream system.
- III. Restoration and acquisition plans shall be developed and implemented to safeguard such critical habitats as estuaries, coastal lagoons, and spawning and rearing areas, and to protect or guarantee future instream flows. All steelhead streams shall be inventoried for quantity and quality of habitat, including stream flow conditions. Steelhead Restoration Card and other funding shall be directed to implement the plans.
- IV. Existing steelhead trout habitat shall not be diminished further without offsetting mitigation of equal or greater long-term habitat benefits. All available steps shall be taken to prevent loss of habitat, and the Department shall oppose any development or project which will result in irreplaceable losses. Artificial production shall not be considered appropriate mitigation for loss of wild fish or their habitat.
- V. Sport fishing for sea-run steelhead shall be encouraged where the Department has determined that harvest will not harm existing wild populations. Harvest of juveniles shall only be permitted where such harvest does not impair adequate returns of adults for sport fishing and spawning. Special restrictions on the harvest of wild juvenile steelhead may be necessary when a fishery includes both wild and hatchery stocks.
- VI. Resident fish will not be planted or resident fisheries developed in drainages of steelhead waters, where, in the opinion of the Department, such planting or development will interfere with steelhead populations.
- VII. Exceptions to this policy may be made by the Commission (a) where the stream is no longer adaptable to anadromous runs, or (b) during the mid-summer period in those individual streams considered on a water-by-water basis where there is a high demand for angling recreation, and such planting or development has been determined by the Department not to be detrimental to steelhead.

CALIFORNIA SALMONID STREAM HABITAT RESTORATION MANUAL

The following waters are excepted.

Nacimiento River	San Luis Obispo County
North Fork Battle Creek	Shasta County, upstream from Manton
Cow Creek	Shasta County upstream from Fern Road and Ingot
Antelope Creek	Tehama County, upstream from Ponderosa Way
Deer Creek	Tehama County, upstream from upper Deer Creek Falls
American River	Sacramento County, only in Arden Pond

Salmon

It is the policy of the Fish and Game Commission that:

- I. Salmon shall be managed to protect, restore and maintain the populations and genetic integrity of all identifiable stocks. Naturally spawned salmon shall provide the foundation for the Department's management program.
- II. Salmon streams shall be inventoried for quantity and quality of habitat, including instream flow requirements. Restoration plans shall identify habitats for restoration and acquisition and opportunities to protect or guarantee future instream flows. Commercial Salmon Trollers Stamp and other funding shall be directed to implement the plans.
- III. Existing salmon habitat shall not be diminished further without offsetting the impacts of the lost habitat. All available steps shall be taken to prevent loss of habitat, and the Department shall oppose any development or project which will result in irreplaceable loss of fish. Artificial production shall not be considered as appropriate mitigation for loss of wild fish or their habitat.
- IV. Salmon shall be rescued only when they will be returned to the stream system of origin. Rescue of juvenile salmon shall be limited to circumstances where fish can be held until habitat conditions improve, or where immediate release can be made in understocked areas of their natal stream system.
- V. In coastal streams without Department hatcheries, artificial rearing shall be limited to areas where the Department determines it would be beneficial to supplement natural production to re-establish or enhance the depleted wild population. In the Sacramento, American, Feather, San Joaquin, Klamath, and Trinity river systems, hatchery production shall be used to meet established mitigation goals. At the discretion of the Department excess eggs and fish from State, Federal, or cooperative hatcheries may be used to provide additional fish for the commercial and sport fisheries.
- VI. Resident fish will not be planted or resident fisheries developed in drainages of salmon waters, where, in the opinion of the Department, such planting or development will interfere with salmon populations. Exceptions to this policy may be authorized by the Commission (a) where the stream is no longer adaptable to anadromous runs, or (b) during the mid-summer period in those individual streams considered on a water-by-water basis where there is a high demand for angling recreation and such planting or development has been determined by the Department not to be detrimental to salmon.

CALIFORNIA SALMONID STREAM HABITAT RESTORATION MANUAL

Classification and Management System

The classification system shall be employed to define the appropriate stocks and the role of artificial production for management of each salmon and steelhead stream in California. This classification may be applied to drainages, individual streams, or segments of streams as necessary to protect discrete stocks of salmon or steelhead. Only designated appropriate stocks may be placed or artificially produced in any stream within the guidelines specified under this classification system. Exceptions to these management constraints may be allowed only under emergency conditions that substantially threaten the long-term welfare of the fishery. Exceptions may only be granted upon submission of a written request, which details the emergency conditions, by a DFG region or an Inland Fisheries Division (IFD) Assistant Chief to the Chief of IFD. The IFD Chief will review the request and make recommendations for approval or denial to the Deputy Director of Fisheries who will then approve or deny the request.

Salmon and Steelhead Stream Classification System Terms

The salmon or steelhead stocks stream management goal shall manage streams for the following appropriate stock and only those stocks may be placed in the stream (each term is progressively inclusive of the preceding terms):

- a. Endemic - Only historic naturally reproducing fish originating from the same stream or tributary.
- b. Naturally reproducing stocks within drainage - Naturally reproducing stocks from the drainage of which the stream is part.
- c. Hatchery stocks within basin - Stocks which may include hatchery produced fish from streams within the drainage.
- d. Naturally reproducing stocks from out of basin - Naturally reproducing stocks from streams outside the basin.
- e. Hatchery stocks out of basin - Stocks which may include hatchery produced fish from streams outside the basin.
- f. Any stock - Any stock which appears to exhibit characteristics suitable for the stream system.

CALIFORNIA SALMONID STREAM HABITAT RESTORATION MANUAL

Artificial production limitations shall be defined according to the following terms. The Department of Fish and Game (DFG) guidelines for cooperative fish production in California are included as Appendix B.

- a. None - No artificial production or fish planting permitted. Manage for natural reproduction. Rearing habitat fully occupied by natural production in most years.
- b. Supplementary - Artificial production is less desirable than natural production and is allowed only to the extent that it provides for full stocking of the stream. Artificial production shall be construed to be a temporary measure until such time as the DFG determines the stream to be fully stocked, but shall not continue beyond 5 years without formal review by the appropriate Regional Fisheries Management Supervisor and Inland Fisheries Division representative. Releases of artificially reared fish shall be distributed to minimize disruption of naturally produced salmon or steelhead.
- c. Complementary - Artificial production is as important for fishery management purposes as natural production and hatchery production may be used on a permanent basis to complement natural production. The level of hatchery production shall not significantly interfere with natural reproduction and survival.
- d. Hatchery - Managed principally for hatchery production with natural production protected but considered secondary.

CALIFORNIA SALMONID STREAM HABITAT RESTORATION MANUAL

DEPARTMENT OF FISH AND GAME FISH SCREEN POLICY

This fish screening policy is structured to comply with existing fish screening statutes, the National Environmental Policy Act (NEPA), the California Environmental Quality Act (CEQA), the Federal Endangered Species Act of 1973 (ESA), the California Endangered Species Act (CESA), and court decisions in place at the time of its adoption. All diversions shall be dealt with uniformly on a statewide basis, as outlined in this policy memorandum.

Diversions Covered By Section 6100

The Department of Fish and Game shall require the installation of fish screens under Section 6100 et seq. of the Fish and Game Code on any new diversion, or on the intake of any existing diversion that is either enlarged, relocated, or at which the season of use is changed, in salmon and steelhead (anadromous) waters of the State.

In addition, all diversions covered by this section which are located within the essential habitat of a State-CESA listed species or the critical habitat of a Federal-ESA listed species shall be screened.

Variations from these requirements shall be supported by a report, prepared by the diverter, which includes data from onsite monitoring and a review of historical entrainment and diversion data. The scope of the report and the sampling effort shall be approved by the Department of Fish and Game prior to the initiation of work.

Both approval of the scope of the report and approval of an exception to this policy shall require the concurrence of the appropriate Regional Manager, the Chief of the Inland Fisheries Division, and the Chief of the Environmental Services Division. The final exception notice shall be issued by the Deputy Director - Fisheries.

Diversions Covered By Section 5980

The Department of Fish and Game shall investigate, and where necessary, order fish screens installed on all diversions which affect fishery resources with a capacity greater than 250 cubic feet per second (cfs). Diversions in anadromous waters of the State shall be screened unless onsite sampling demonstrates otherwise.

In addition, all diversions covered by this section which are located within the essential habitat of a State CESA-listed species or the critical habitat of a Federal-ESA listed species shall be screened.

Variations from these requirements shall be supported by a report prepared by the diverter, which includes data from onsite monitoring, and a review of historical entrainment and diversion data. The scope of the report and the sampling effort shall be approved by the Department of Fish and Game prior to the initiation of work.

CALIFORNIA SALMONID STREAM HABITAT RESTORATION MANUAL

Both approval of the scope of the report, and approval of an exception to this policy shall require the concurrence of the appropriate Regional Manager, the Chief of the Inland Fisheries Division, and the Chief of the Environmental Services Division. The final exception notice shall be issued by the Deputy Director - Fisheries.

Diversions Covered By Section 6020

The Department of Fish and Game may consider for screening any diversion with a capacity of 250 cfs or less. Activities in this category should be assigned a lower priority than those covered by provisions of Section 5980, until all of the Department of Fish and Game obligations for both its own diversions, and for those diversions with a capacity greater than 250 cfs, have been fulfilled.

In addition, all diversions covered by this section which are located within the essential habitat of a State CESA-listed species or the critical habitat of a Federal-ESA listed species shall be screened.

Variances from these requirements shall be supported by a report, prepared by the diverter, which includes data from onsite monitoring, and a review of historical entrainment and diversion data. The scope of the report and the sampling effort shall be approved by the Department of Fish and Game, prior to the initiation of work.

Both approval of the scope of the report, and approval of an exception to this policy shall require the concurrence of the appropriate Regional Manager, the Chief of the Inland Fisheries Division, and the Chief of the Environmental Services Division. The final exception notice shall be issued by the Deputy Director - Fisheries.

NEPA And CEQA Processes

When reviewing projects, the Department of Fish and Game shall make every effort to require the installation of fish screens on all unscreened diversions where other measures cannot reasonably prevent entrainment of fish. Further, the Department of Fish and Game shall make every effort to require modernization of fish screens which do not meet our present fish screening criteria. This effort shall include the Streambed Alteration Agreement process (Section 1600 et seq. of the Fish and Game Code). Variances from the fish screening policy shall be treated as discussed above.

Fish and Wildlife Coordination Act

Under the provisions of this Federal legislation enacted in 1934, the Department of Fish and Game shall require installation of fish screens on all unscreened diversions where fish are present. Further, the Department of Fish and Game shall make every effort to require improvement of fish screens not meeting our present screening criteria. For example, opportunities are provided by the U.S. Army Corps of Engineers permit process under the Federal Rivers and Harbors and Clean Water acts.

CALIFORNIA SALMONID STREAM HABITAT RESTORATION MANUAL

The “General Fish Screening Criteria” shall be used as the basis for design of fish screens required under this policy. The need-to-screen criteria may be modified by the Department of Fish and Game, and it is the responsibility of the project proponent to have the most recent copy of these agreement criteria. Copies are available from either the Environmental Services Division or the In land Fisheries Division of the Department of Fish and Game.

SENATE BILL 2261 (CHAPTER 1545, Statutes of 1988)

SENATE BILL 2261, introduced by Senator Barry Keene. Salmon, Steelhead Trout, and Anadromous Fisheries Program Act) added Chapter 8 (commencing with section 6900) to Part 1 of Division 6 of the Fish and Game Code, relating to fish, making an appropriation therefore, and declaring the urgency thereof, to take effect immediately.

The people of the State of California do enact as follows:

SEC. 1. The Legislature finds that the Advisory Committee on Salmon and Steelhead Trout, reestablished by Resolution Chapter 141 of the Statutes of 1983, has conducted a thorough inquiry into the decline of the naturally spawning salmon and steelhead trout resources of the state and has presented to the public its findings and recommendations for legislative and administrative actions to protect and increase those resources. As a result of the advisory committee’s inquiry, findings, and recommendations, the Legislature has recommended the establishment of a salmon, steelhead trout, and anadromous fisheries program set forth in Chapter 8 (commencing with Section 6900) of Part 1 of Division 6 of the Fish and Game Code.

SEC. 2. Chapter 8 (commencing with Section 6900) is added to Part 1 of Division 6 of the Fish and Game Code, to read:

CALIFORNIA SALMONID STREAM HABITAT RESTORATION MANUAL

CHAPTER 8. SALMON, STEELHEAD TROUT, AND ANADROMOUS FISHERIES PROGRAM ACT

Article 1. Citation and Legislative Findings

6900. This chapter shall be known and may be cited as the Salmon, Steelhead Trout, and Anadromous Fisheries Program Act.

6901. The Legislature, for purposes of this chapter, finds as follows:

(a) According to the department, the natural production of salmon and steelhead trout in California has declined to approximately 1,000,000 adult chinook or king salmon, 100,000 coho or silver salmon, and 150,000 steelhead trout.

(b) The naturally spawning salmon and steelhead trout resources of the state have declined dramatically within the past four decades, primarily as a result of lost stream habitat on many streams in the state.

(c) Much of the loss of salmon and steelhead trout and anadromous fish in the state has occurred in the central valley.

(d) Protection of, and in increase in, the naturally spawning salmon and steelhead trout resources of the state would provide a valuable public resource to the residents, a large statewide economic benefit, and would, in addition, provide employment opportunities not otherwise available to the citizens of this state, particularly in rural areas of present underemployment.

(e) Proper salmon and steelhead trout resource management requires maintaining adequate levels of natural, as compared to hatchery, spawning and rearing.

(f) Reliance upon hatchery production of salmon and steelhead trout in California is at or near the maximum percentage that it should occupy in the mix of natural and artificial hatchery production in the state. Hatchery production may be an appropriate means of protecting and increasing salmon and steelhead in specific situations; however, when both are feasible alternatives, preference shall be given to natural production.

(g) The protection of, and increase in, the naturally spawning salmon and steelhead trout of the state must be accomplished primarily through the improvement of stream habitat.

(h) Funds provided by the Legislature since 1978 to further the protection and increase of the fisheries of the state have been administered by the Department of Fish and Game in a successful program of contracts with local government and nonprofit agencies and private groups in ways that have attracted substantial citizen effort.

(i) The Department's contract program has demonstrated that California has a large and enthusiastic corps of citizens that are eager to further the restoration of the stream and fishery resources of this state and that are willing to provide significant amounts of time and labor to that purpose.

(j) There is need for a comprehensive salmon, steelhead trout, and anadromous fisheries plan, program, and state government organization to guide the state's efforts to protect and increase the naturally spawning salmon, steelhead trout, and anadromous fishery resources of the state.

CALIFORNIA SALMONID STREAM HABITAT RESTORATION MANUAL

6902. The Legislature, for purposes of this chapter, declares as follows:

(a) It is the policy of the state to significantly increase the natural production of salmon and steelhead trout by the end of this century. The Department shall develop a plan and a program that strives to double the current natural production of salmon and steelhead trout resources.

(b) It is the policy of the state to recognize and encourage the participation of the public in privately and publicly funded mitigation, restoration, and enhancement programs in order to protect and increase naturally spawning salmon and steelhead trout resources.

(c) It is the policy of the state that existing natural salmon and steelhead trout habitat shall not be diminished further without offsetting the impacts of the lost habitat.

Article 2. Definitions

6910. Unless the context clearly requires a different meaning, the definitions in this article govern the construction of this chapter.

6911. "Production" means the survival of fish to adulthood as measured by the abundance of the recreational and commercial catch together with the return of fish to the state's spawning streams.

6912. "Program" means the program for protection and increasing the naturally spawning salmon and steelhead trout of the state provided for in Article 3 (commencing with Section 6920).

Article 3. Salmon, Steelhead Trout, and Anadromous Fisheries Program

6920. (a) The Department shall, with the advice of the Advisory Committee on Salmon and Steelhead Trout and the Commercial Salmon Trollers Advisory Committee, prepare and maintain a detailed and comprehensive program for the protection and increase of salmon, steelhead trout, and anadromous fisheries.

(b) The Department shall consult with every public agency whose policies or decisions may affect the goals of this program to determine if there are feasible means for those public agencies to help the Department achieve the goals of this program.

6921. The program shall identify the measures the Department will carry out to achieve the policies set fourth in Section 6902.

6922. The program shall include, but is not limited to, all of the following elements:

(a) Identification of streams where the natural production of salmon and steelhead trout can be increased primarily through the improvement of stream and stream bank conditions without effect on land ownership, land use practices, or changes in stream flow operations.

(b) Identification of streams where the natural production of salmon and steelhead trout can be increased only through the improvement of land use practices or changes in stream flow operations.

(c) Identification of streams where the protection of, and increase in, salmon and steelhead trout resources require, as a result of significant prior loss of stream habitat, the construction of artificial propagation facilities.

(d) A program element for evaluating the effectiveness of the program.

(e) Recommendations for an organizational structure, staffing, budgeting, long-term sources of funding, changes in state statutes and regulations and federal and local government policy and such other administrative and legislative actions as the Department finds to be necessary to accomplish the purposes of this chapter.

CALIFORNIA SALMONID STREAM HABITAT RESTORATION MANUAL

(f) Identification of measures to protect and increase the production of other anadromous fisheries consistent with policies set forth in Section 6902.

(g) Identification of alternatives to, or mitigation of, manmade factors which cause the loss of juvenile and adult fish in California's stream systems.

6923. Measures which are the responsibility of other agencies or persons, such as the repair or replacement of dysfunctional fish screens, are not eligible for funding under the program.

6924. The Department shall determine the initial elements of the program and transmit a report describing those elements to the Legislature and the Advisory Committee on Salmon and Steelhead Trout within six months of the effective date of this chapter.

SEC. 3. The Department of Fish and Game shall determine the initial elements of the salmon, steelhead trout, and anadromous fisheries program initiated pursuant to Chapter 8 (commencing with Section 6900) of Part 1 of Division 6 of the Fish and Game Code, shall coordinate existing programs, and shall implement the elements of the program. In addition to the personnel positions authorized in the Budget Act of 1988, the Department shall use moneys allocated to the salmon, steelhead trout, and anadromous fisheries program, upon appropriation by the legislature, to provide three additional personnel years for the purposes of maintaining a salmon, steelhead trout, and anadromous fisheries program. The Department shall annually submit a budget for the purpose of continuing this program.

SEC. 4. The sum of one hundred twenty-five thousand dollars (\$125,000) is hereby appropriated from the Environmental License Plate Fund, and the sum of one hundred sixty-six thousand dollars (\$166,000) is hereby appropriated from the Fish and Game Preservation Fund to the Department of Fish and Game to establish the salmon, steelhead trout, and anadromous fisheries program pursuant to Chapter 8 (commencing with Section 6900) of Part 1 of Division 6 of the Fish and Game Code. The Department may also utilize its allocation of funds received pursuant to Chapter 10B (commencing with Section 777) of Title 16 of the United States Code for this program.

SEC. 5. This act is an urgency statute necessary for the immediate preservation of the public peace, health, or safety within the meaning of Article IV of the Constitution and shall go into immediate effect. The facts constituting the necessity are:

The decline of naturally spawning salmon, steelhead trout, and other anadromous fish resources is occurring at such a rate that some segment of these native California fish may be threatened with extinction. In order to stop the decline and restore the fishery resource at the earliest possible time, it is necessary that this act take effect immediately.

CALIFORNIA SALMONID STREAM HABITAT RESTORATION MANUAL

APPENDIX B.

COOPERATIVE FISH PRODUCTION IN CALIFORNIA

Artificial fish production is accomplished through three separate administrative processes:

- State or Federal hatcheries operated for mitigation of water project damages or for fisheries enhancement.
- Aquaculture contracts for production of mitigation or fisheries enhancement fish for public harvest. Some fish such as striped bass are reared for mitigation purposes by registered aquaculturists; refer to IFD Informational Leaflet No. 34 for the laws and regulation on aquaculture.
- Cooperative fish rearing operations for production of fish to accelerate fisheries restoration or to enhance fisheries.

Each of these options for fish production can play an important role in the management and restoration of California's fisheries resources. In addition to maintaining State hatcheries, the Department of Fish and Game (DFG) strongly advocates involvement by the public sector where it is economically and operationally advantageous to the fisheries. The policies and State laws pertaining to cooperative fish rearing which permit, contract, or grant rearing of public domain fish for return to the public domain are aimed at maintenance of a strong and beneficial public involvement in fish rearing. Aquaculture is regulated under a special set of laws and regulations which permit the sale of the fish produced.

SPECIAL PURPOSE FACILITIES

A wide variety of facilities and strategies are used by DFG and its cooperators to fulfill the needs for artificial production of fish for restoration and enhancement.

Rescue Rearing

Annually, Department personnel rescue fish stranded in inhospitable conditions due to poor water quality or lack of flow. The fish are collected and then relocated to suitable waters. Occasionally, it is preferable to place rescued fish in rearing facilities where the fish are grown to a larger size and released to the wild at the time of year most likely to result in their survival. Rearing facilities for rescued fish may be used to insure the survival of a run of fish, to reintroduce fish to suitable streams, or where natural rearing conditions have temporarily been too severely degraded to maintain wild populations.

Trapping Weirs

Trapping weirs are sometimes used to trap fish for tagging, marking, measuring, transporting, or obtaining eggs for fish rearing programs. These weirs are usually fish-proof fences installed across streams to direct fish into a containment device. All fish moving upstream or downstream can be stopped at the weir and can only pass when the weir and trap are deactivated

CALIFORNIA SALMONID STREAM HABITAT RESTORATION MANUAL

or removed. Care must be taken to avoid harming fish during handling, and juvenile fish must be provided a hiding place in the trap to reduce predation by larger fish or by other species that have been captured.

Weirs used for counting or marking fish are sometimes kept in operation for days or even weeks to obtain the necessary number of fish to meet the purpose of the project. Fish not retained for project purposes are observed or marked and then released to continue on their way.

Weirs used for obtaining fish for relocation to another area or for obtaining eggs are normally installed for a short period of time or are periodically deactivated to allow the majority of the fish to pass unhindered. This allows the stream to retain its basic population of fish, and reduces the potential for adversely impacting production of the stream. A weir is not allowed in areas where it could cause harm to the fishery.

Ocean Net Pen Rearing

Ocean net pen rearing operations are used to rear and acclimate chinook salmon fingerlings from freshwater to salt water conditions in a protected environment where the salmon can be imprinted to the nearby bay. Ocean net pen rearing is used mainly for ocean fishery enhancement.

Ocean net pen rearing operations require suitable water quality and temperature, water depth, and minimal tidal action in the harbor or bay. Usually a plastic liner is inserted into the net pen which is filled with filtered fresh water and oxygenated. Over a period of three to six days, sea water is gradually added until the liner contains full strength sea water. The liners are then removed, as the salmon are then acclimated to the sea water. The chinook salmon are usually reared from two weeks to four months for imprinting purposes. The longer term provides protection for the chinook salmon during poor summer ocean conditions, El Nino events, and predators. The fish are released at the rearing location when they have reached a targeted size.

Rearing Ponds or Other Facilities

DFG cooperators typically produce salmon and steelhead juveniles by rearing fish in small artificial ponds. The rearing ponds require fry from an acceptable sources. Most frequently, to meet genetic stock selection requirements, the fry are from eggs taken from natal fish captured in local streams and the eggs are incubated in a hatch box, egg baskets, or in stacks of egg trays.

Rearing facilities require a reliable source of high quality water ranging in temperature from 45E to 59E Fahrenheit. All water intake structures must meet Department of Fish and Game fish proof screening and flow bypass criteria. These specifications are found within the Fish and Game Code Sections 5900 - 6100 et. seq. Required screen size is listed in a 1984 memo by Department of Fish and Game Engineers. This memo is available from the Department of Fish and Game, Environmental Services Division at DFG Regional offices.

Chinook salmon are typically reared until mid-May and are released as juveniles weighing no less than 90 fish to the pound. Coho salmon and steelhead trout require similar water conditions but should be reared for one full year. Coho salmon must be released in March, April, or May. Generally, survival for steelhead is greatest for large fish that count 2 or 3 to the pound

CALIFORNIA SALMONID STREAM HABITAT RESTORATION MANUAL

when they are released as one-year-old fish during the winter months. Coho that are too large at time of release will frequently return to the spawning grounds the following fall as "grilse" which are only two years old. Grilse do not contribute to the commercial fishery and seldom contribute to the sport fishery. For that reason, it is better to release coho in March, April, or May at 6 to 12 fish to the pound so they will be more likely to spend two summers growing in the ocean. Some cooperators, with expressed permission from the Department, may release fish at smaller sizes into newly restored or underseeded areas. This allows the fish to "imprint" on the area for future returns. The fish generally will stay within the area until stream flows and temperatures trigger natural migration downstream to the ocean. Usually, only one species of fish is allowed to be released in one location to prevent inordinate levels of competition for food and habitat.

GENETIC CONSIDERATIONS

Genetic considerations must be made in the selection of fish stocks for rearing or relocation programs. Live salmon and steelhead may not be taken from one stream or lake and put in a different stream without a specific permit from DFG. Generally, movement of fish will be allowed within all or part of a river system or drainage basin. This means that transportation of live fish is limited to areas that the genetic strain of fish could normally be expected to frequent on their own.

These limitations on the transportation and stocking of live fish into different rivers is to protect the general fish population. Fish from different waters could carry disease unique to their source stream. This could cause mortality among fish endemic to the receiving stream. Conversely, the transplanted stocks could lack immunity to diseases present in their new home. Introduced fish that are not genetically suited to their new home can also have long term effects on their new neighbors. If the fish interbreed, which would typically happen, then their offspring may inherit genetic traits that are not suited for survival in some part of their ocean or stream habitats. For example, stocks genetically suited to a short migration would be ill suited for locations far from the ocean. Some stocks are suited for late winter spawning; these would not do well in a location that only provided favorable spawning conditions in autumn. If some limited reproduction did occur, even with endemic stocks, their offspring would likely be poorly suited for survival.

Habitat conditions and genetic adaptations determine the long-term productivity and survival of salmon or steelhead stocks. Subtle differences in habitat, genetics, and endemic stocks must be carefully evaluated before stock transfer is carried out. Generally, relocation is restricted to intra-basin transfer, or to similar, nearby watersheds. Relocation of fish from the South Fork Eel River fall-run chinook population is confined to the South Fork Eel River and its tributaries, and to Warm Springs Hatchery on the Russian River where there are no native fall-run chinook to be impacted. Larger streams like the Sacramento River are restricted even further; fish from the lower Sacramento are used to stock the upper half of the river only in emergencies.

CALIFORNIA SALMONID STREAM HABITAT RESTORATION MANUAL

GENERAL INFORMATION ABOUT PUBLICLY OPERATED FISH REARING PROGRAMS

Contracts and permits that may be required:

- Before trapping or spawning any fish, all fish rearing projects must have a permit from the appropriate DFG Regional Manager.
- A National Marine Fisheries Service (NMFS) permit is required before handling any fish listed by the Federal Threatened and Endangered Species Act.
- Any lake or streambed alteration requires a written 1601-1603 agreement from the local Fish and Game Biologist or Warden.
- Certified Spawn Taker: A DFG training session must be attended by any individual actively participating in an artificial spawning (egg taking) project.
- A State Water Resources Control Board permit is required for appropriative water use.
- Water pumped from a stream requires a 1601-1603 agreement from the area Fish and Game Biologist or Warden.
- A Regional Water Quality Control Board waste discharge permit is required for any discharge.
- No payments will be made to a contractor without a fully executed contract, memorandum of understanding, or joint powers agreement. Payments will not be made for work completed before the approval date or after the closing date of the contract.
- No work will be started until all permits have been obtained, and copies mailed to the Contract Administrator. All cooperative rearing projects must conform to the California Environmental Quality Act.
- All publicly operated fish rearing facilities will be linked to restoration goals and objectives with an approved written project and management plan providing for evaluation and covering a period of five years, linked to an overall long-term watershed fishery restoration plan.

CALIFORNIA SALMONID STREAM HABITAT RESTORATION MANUAL

Fish Culture Practices and Site Requirements

- An adequate water supply, with a suitable emergency backup system, through the proposed period of operation must be demonstrated.
- Water temperatures between 42E and 56E Fahrenheit are required for egg incubation.
- Year round water temperatures between 45E and 59E Fahrenheit are required for rearing yearling or post-smolt salmonids.
- Water supplies must have a minimum of seven parts per million dissolved oxygen, and be free of harmful gasses and pollutants. A pH between 6.7 and 8.2 is desirable.
- Zinc, copper, lead, and cadmium are lethal to fish and eggs. Galvanized pipe may not be used for hatchery or incubator water supplies.
- Ultraviolet lighting, such as fluorescent lights, may not be used in spawning and incubation areas. UV light, especially sunlight, is detrimental to fish eggs. Incandescent lighting is recommended. Windows should be covered with black plastic to prevent sunlight from entering the room.
- Feeding must be started when swim-ups appear. The appropriate size starter mash for the species will be fed at least 10 times daily during this early feeding stage. Larger fish must also be fed daily though less often. DFG Fish Bulletin 164 should be consulted for feeding criteria in conjunction with the food chart provided by the feed supplier.
- Rearing ponds must be cleaned on a regular basis to prevent build-up of biomass and algae as a control for diseases. Biomass and algae contribute to the production of toxic gasses which is lethal to fish.
- The rearing and incubation facility must be secure from vandals and predators. The facility must be kept in a clean condition at all times.
- Frozen fish food must be kept at -10E Fahrenheit. No more than two daily feedings may be thawed at one time. No feed will be used after the lot expiration date.
- Fish screen sizes should be changed as fish grow. See DFG Fish Bulletin 164 for details.
- No treatment other than salt can be used without prior written permission from the DFG Pathology Section.

CALIFORNIA SALMONID STREAM HABITAT RESTORATION MANUAL

- It is DFG policy that steelhead trout and coho salmon will be raised to yearlings before release. Chinook salmon will be raised to a minimum size of 90 fish to the pound.
- If a project does not receive the eggs or fish agreed upon in the regional permit, the contract funds will be reduced using criteria established by DFG.
- Cost effectiveness will be calculated for each project based upon fish and egg inventories and total dollars spent.

SPECIFIC GUIDELINES FOR CREATION OF FIVE-YEAR FISH REARING PLAN

The following outline is a guide for the production of a five-year fish rearing plan, as required by State Fish and Game Commission Policy, for the operation of a cooperative fish rearing facility.

The purpose of the five-year fish rearing plan is to develop background information, goals, operational procedures, and monitoring plans for all existing and proposed cooperative fish rearing programs, regardless of funding sources. This plan will assist Department personnel to assess the environmental issues and suitability of existing and proposed programs. An update of the five-year management plan will be required when any major change occurs in hatchery operation, watershed condition, or new environmental issues are raised concerning the rearing facility and/or watershed. The plan is the responsibility of the project sponsors but should be developed with input from the DFG regional fishery biologist. The supervisor of the regional fisheries program will make the final decision concerning the acceptance of the management plan.

The acceptance of the five-year management plan does not guarantee five years of project operation, but it does indicate the Department's intention to provide the necessary trapping and rearing permits as long as the project adheres to the approved plan. The project sponsor is responsible for providing adequate project funding and obtaining all necessary permits.

Program Summary

Project Name:

Organization: (give name and address)

Contact Person: (give name, address and telephone)

Program Goal: (give purpose and objective(s) of program, including number of years of operation)

General Rearing Plan: (separate information for each species)

Species of fish to be reared:

Number to be reared:

Size(s) at release:

Date(s) of release:

CALIFORNIA SALMONID STREAM HABITAT RESTORATION MANUAL

Release site(s):

Source of eggs or fry:

Project Funding: (state how project will be funded)

Supporting and Cooperating Organizations: (give names and addresses and a contact person)

(start new page for remainder of information)

Detailed Project Description

Project Location: (mark locations on map or indicate latitude and longitude of rearing, release and trapping sites, and describe physical and legal access; describe land ownership and land use agreement)

Rearing Water Source:

Flow: (for the rearing period give range of flows expected at water source, for both primary and emergency backup)

Water rights: (describe the status of the water right)

Temperature: (give range in temperature of water source during rearing period)

Turbidity: (describe seasonal levels of turbidity and settleable solids to be expected in water source)

Dissolved oxygen: (provide any available information on dissolved oxygen levels of water source(s))

Other water quality factors: (provide any available information on chemical makeup of water at source(s))

Physical Facilities: (fully describe rearing facilities including water delivery system, water treatment system, capacity of water delivery system, type and size of rearing tanks or ponds, pond effluent treatment facilities (must meet Regional Water Quality Control Board requirements), and water discharge system - include a full set of diagrams)

Egg incubation facilities (if any): (provide same information as required for "Rearing Facilities," including diagrams)

Adult trapping and egg taking facilities (if any): (fully describe adult trapping and egg taking facilities including type of trap, holding tanks and spawning area and equipment - including full set of diagrams)

Plan of Operation:

Water system: (fully describe capacity and operation of system including water collection and delivery (for both primary and backup), water treatment (including aeration and removal of sediment and any toxicants, and treatment of effluent))

Rearing facilities: (fully describe operation of facilities including number of eggs or fry needed, pond loading rates (number of fish per gallon), feeding methods and rates, type of food, removal of wastes, treatment of disease (note: DFG approval required for use of chemicals) and recovery of fish)

CALIFORNIA SALMONID STREAM HABITAT RESTORATION MANUAL

Egg incubation facilities (if any): (fully describe operation of facilities including incubator loading rates, treatment of disease and recovery of fry)

Adult trapping and egg taking facilities (if any): (fully describe operation of facilities including proposed trapping schedule, selection of broodstock, method of spawning and disposition of spawned and unspawned fish)

Personnel: (list persons expected to work on project and describe qualifications of each)

Project Justification

Species Status: (Describe adult and juvenile fish population trends and status in affected stream and drainage; provide information on the affected stream's capacity for both juveniles and adults)

Project Effects:

Wild populations: (fully describe expected positive and negative effects from project on established wild populations in the affected stream and drainage, including expected genetic effects)

Other environmental effects: (describe potential effects, positive and negative, on other hatchery operations, other resources and human uses in the affected area; attach a completed environmental checklist)

Alternatives to Proposed Project: (describe alternatives to the project and their positive and negative aspects - include a "No Project" alternative)

Project Evaluation

Project History: (for established projects, provide annual records by species of adults spawned, eggs taken, number and size planted, affects on wild populations and contribution of the project's production to spawning runs and sport and commercial fisheries)

Concurrent Evaluation: (describe your plan for keeping project records on water temperature, fish mortality, growth, feed rates, fish tagging, fish trapping records, etc.)

Long Term Evaluation: (provide a plan for evaluating the long term effects of the cooperative rearing project by using techniques such as spawning surveys, migrant traps, tagging, etc.)

CALIFORNIA SALMONID STREAM HABITAT RESTORATION MANUAL

FISH AND GAME CODE SECTIONS

Article 1. General Provisions

6400 - Fish placing without permission is unlawful. It is unlawful to place, plant, or cause to be placed or planted, in any of the waters of this State, any live fish, any fresh or salt water animal, or any aquatic plant, whether taken without or within the State, without first submitting it for inspection to, and securing the written permission of the Department.

Article 5. Private Nonprofit Hatcheries

1170 - Permit. The Commission may issue a permit, subject to such restrictions and regulations as the Commission deems desirable, to a nonprofit organization to construct and operate an anadromous fish hatchery.

1171 - Financial capacity as prerequisite. The Commission shall not issue a permit unless it determines the nonprofit organization has the financial capability to successfully construct and operate the hatchery and will diligently and properly conduct operation authorized under the permit.

1172 - Grounds for denial of permit. No permit will be issued which may tend to deplete the natural runs of anadromous fish, result in waste or deterioration of fish, or when proposed operation is located on a stream or river below a State or Federal fish hatchery or egg taking station.

1173 - Hatchery or wild fish; status. All fish handled under authority of this article during the time they are in the hatchery or in the wild are the property of the State and when in the wild may be taken under the authority of a sport or commercial fishing license as otherwise authorized for wild fish.

1174 - Conditions. Any permit granted by the Commission pursuant to this article shall contain all of the following conditions:

- (a) If after a hearing the Commission finds that the operation described in the permit and conducted pursuant to this article is not in the best public interest, the commission may alter the conditions of the permit to mitigate the adverse effects, or may cause an orderly termination of the operation under the permit. An orderly termination shall not exceed a three-year period and shall culminate in the revocation of the permit in its entirety.
- (b) If the Commission finds that the operation has caused deterioration of the natural run of anadromous fish in the waters covered by the permit, it may require the permittee to return the fishery to the same conditions as was prior to issuance of the permit. If the permittee fails to take appropriate action, the Commission may direct the Department to take the action, and the permittee shall bear any cost incurred by the Department.

CALIFORNIA SALMONID STREAM HABITAT RESTORATION MANUAL

- (c) Prior to release into State waters and at any other time deemed necessary by the Department, the fish may be examined by the Department to determine that they are not diseased or infected with any disease which, in the opinion of the Department, may be detrimental to the State fishery resources. (amended by Stats 1986 ch. 1244)

1175 - Operation responsibility. The State shall assume no responsibility for the operation of a hatchery pursuant to this article and shall not be in any manner liable for its operation. (added by Stats 1970 ch. 862)

Note: Section 2 of Chapter 862 provides: Any permit issued under this act shall be on an experimental basis until its impact on the fishery resource can be ascertained and, therefore, this act shall be applicable only to the waters of Rowdy Creek, contained within Del Norte County.

2081 - Endangered species; exceptions. Through permits or memorandums of understanding, DFG may authorize individuals, public agencies, universities, zoologic gardens, and scientific or educational institutions, to import, export, take, or possess any endangered species, threatened species, or candidate species for scientific, educational, or management purposes.

6901 - Legislative findings. The Legislature, for purposes of this chapter (Chapter 8. Salmon, Steelhead Trout, and Anadromous Fisheries Program Act), finds as follows:

- (e) Proper salmon and steelhead trout resource management requires maintaining adequate levels of natural, as compared to hatchery, spawning and rearing.
- (f) Reliance upon hatchery production of salmon and steelhead trout in California is at or near the maximum percentage that it should occupy in the mix of natural and artificial production in the state. Hatchery production may be an appropriate means of protecting and increasing salmon and steelhead in specific situations; however, when both are feasible alternatives, preference shall be given to natural production.
- (g) The protection of, and increase in, the naturally spawning salmon and steelhead trout of the State must be accomplished primarily through the improvement of stream habitat.

ARTICLE 6. Cooperative Salmon and Steelhead Rearing Facilities

1200 - Rearing facilities; agreements. The Department is authorized to enter into agreements with counties, nonprofit groups, private persons, individually or in combination, for the management and operation of rearing facilities for salmon and steelhead. All such agreements shall be in accordance with the policies of the Commission and the criteria of the Department which govern the operation under such agreements.

The purpose for operating such facilities shall be to provide additional fishing resources and to augment the natural runs.

CALIFORNIA SALMONID STREAM HABITAT RESTORATION MANUAL

1201 - Financial ability; demonstration. An applicant who wishes to enter into an agreement to operate a rearing facility shall demonstrate, to the satisfaction of the Department prior to executing such agreement, such applicant's financial ability to properly operate the rearing facility. The Department shall develop and specify the means for an applicant to make such a demonstration.

1203 - Fish release in accordance with policy. The release of fish reared in facilities pursuant to this article shall be made in accordance with the policy of the Commission.

1204 - Funding. The Department shall fund the agreements provided for in Section 1200 only on a matching basis with the person or entities who enter into such agreements. Funds appropriated for the purposes of this article shall not be used to purchase equipment or for construction.

The Department shall be reimbursed from funds appropriate for the purposes of this article for administrative costs, legal costs, and supervisorial costs relating to the execution and supervision of such agreements by the Department.

1205 - Department responsibilities as to fish size, etc. according to agreement. The Department shall, subject to the limitations of appropriate egg sources and funding, make available fish of appropriate size and species to persons or entities who enter into agreements pursuant to this article.

1206 - Salmon, etc. release at point of conception. Salmon and steelhead raised pursuant to this article shall be released in streams, rivers, or waters north of Point Conception and upon release shall have unimpeded access to the sea.

15900 - Private stocking of anadromous fish (ocean ranching). A registered aquaculturist may be granted a permit by the commission, under any terms and conditions that the commission may prescribe, to release and capture anadromous fish in state waters which have been reared in an aquaculture facility. (*Effective only until 1/1/2001.*) Regulations covering this activity are contained in Section 15901 - 15908 of the Code, and Section 238.5 of Title 14.

TITLE 14 OF THE CALIFORNIA ADMINISTRATIVE CODE

238.5 - Stocking of Aquaculture Products

No person shall stock aquaculture products in this state except in accordance with the following general terms and conditions:

- (h) Except for those specific areas and waters covered in Section 238.5 (c)(1) and all authorized species not listed in Section 238.5(c), no person shall stock aquatic plants and animals except as follows:
 - 1) Each stocking of fish shall require a separate Private Stocking Permit (FG 749) issued by the department. A copy of this permit shall accompany all shipments. However, with the exception of Inyo and Mono counties, a copy of the same permit

CALIFORNIA SALMONID STREAM HABITAT RESTORATION MANUAL

(FG 749) may be used for additional consignments of the same species when stocked in the same water, until canceled by the Department.

- 2) Application for the private stocking permit shall be made to the regional manager of the DFG Region in which the fish are to be stocked. An application will be supplied to each applicant upon request.
- 3) No person shall stock any species of fish in any water in which the stocking of such fish is contrary to the fisheries management programs of the Department for that water or drainage, or in any water from which such fish might escape to other waters where such fish are not already present. All applicants will be advised upon request of the said departmental fisheries management programs.
- 4) Permittee shall notify the regional office of the department not less than 10 days in advance of stocking in order to make arrangements for inspection. Such inspection may be waived at the discretion of the Department. If, upon inspection, diseased or parasitized fish or fish of unauthorized species are found by the Department to be present, they shall be disposed of by the permittee as directed by the Department. The Department may require that the expense of any inspection made necessary by the provisions of these regulations be borne by the permittee.

FISH AND GAME COMMISSION POLICY

COOPERATIVELY OPERATED REARING PROGRAMS FOR SALMON AND STEELHEAD

- I. The State's salmon and steelhead resources may be used to support cooperative rearing programs. Rearing programs may be of two types: (1) those that grow fish for use in accelerating the restoration/rehabilitation of depleted wild populations in underseeded habitat and (2) those that are dedicated solely to growing fish for harvest. The following constraints apply to both types:
 - A. Only those fish surplus to the needs of the Department's programs shall be utilized for such programs and allocation shall be based on past performance and the Department's evaluation of the potential of proposed new programs.
 - B. The suitability and acceptance or rejection of proposed programs shall be determined by the Department after reviewing a written proposal. A written project and management plan providing for evaluation and covering a period of five years must be evaluated and approved by the Department. Prior to reauthorization the Department must determine that the project is in compliance with the approved plan and continuance of the program is in the best interest of the State's fishery resources.
 - C. Routine care and food costs shall be the financial responsibility of the sponsoring entity. The Department shall provide technical advice and special assistance as appropriate.

CALIFORNIA SALMONID STREAM HABITAT RESTORATION MANUAL

- D. Fish raised in these programs shall not be stocked in, or broodstock captured from, waters where the Department has determined that adverse effects to native fish populations or other aquatic species may result.

- II. The bulk of the state's salmon and steelhead resources shall be produced naturally. The State's goals of maintaining and increasing natural production take precedence over the goals of cooperatively operated rearing programs.

SALMON

It is the policy of the Fish and Game Commission that:

- I. Salmon shall be managed to protect, restore and maintain the populations and genetic integrity of all identifiable stocks. Naturally spawned salmon shall provide the foundation for the Department's management program.

- II. Salmon streams shall be inventoried for quantity and quality of habitat, including instream flow requirements. Restoration plans shall identify habitats for restoration and acquisition and opportunities to protect or guarantee future instream flows. Commercial Salmon Trollers Stamp and other funding shall be directed to implement the plans.

- III. Existing salmon habitat shall not be diminished further without offsetting the impacts of the lost habitat. All available steps shall be taken to prevent loss of habitat, and the Department shall oppose any development or project which will result in irreplaceable loss of fish. Artificial production shall not be considered as appropriate mitigation for loss of wild fish or their habitat.

- IV. Salmon shall be rescued only when they will be returned to the stream system of origin. Rescue of juvenile salmon shall be limited to circumstances where fish can be held until habitat conditions improve, or where immediate release can be made in understocked areas of their natal stream system.

- V. In coastal streams without Department hatcheries, artificial rearing shall be limited to areas where the Department determines it would be beneficial to supplement natural production to re-establish or enhance the depleted wild population. In the Sacramento, American, Feather, San Joaquin, Klamath, and Trinity river systems, hatchery production shall be used to meet established mitigation goals. At the discretion of the Department excess eggs and fish from State, Federal, or cooperative hatcheries may be used to provide additional fish for the commercial and sport fisheries.

- VI. Resident fish will not be planted or resident fisheries developed in drainages of salmon waters, where, in the opinion of the Department, such planting or development will interfere with salmon populations. Exceptions to this policy may be authorized by the Commission (a) where the stream is no longer adaptable to anadromous runs, or (b) during the mid-summer period in those individual streams considered on a water-by-

CALIFORNIA SALMONID STREAM HABITAT RESTORATION MANUAL

water basis where there is a high demand for angling recreation and such planting or development has been determined by the Department not to be detrimental to salmon.

STEELHEAD RAINBOW TROUT

It is the policy of the Fish and Game Commission that:

- I. Steelhead rainbow trout shall be managed to protect and maintain the populations and genetic integrity of all identifiable stocks. Naturally spawned steelhead shall provide the foundation of the Department's management program.
- II. Steelhead shall be rescued only when they will be returned to the stream system of origin. Rescue of juvenile steelhead shall be limited to circumstances where fish can be held until habitat conditions improve, or where immediate release can be made in understocked areas of their natal stream system.
- III. Restoration and acquisition plans shall be developed and implemented to safeguard such critical habitats such as estuaries, coastal lagoons, spawning and rearing areas, and to protect or guarantee future instream flows. All steelhead streams shall be inventoried for quantity and quality of habitat, including stream flow conditions. Steelhead Restoration Card and other funding shall be directed to implement the plans.
- IV. Existing steelhead trout habitat shall not be diminished further without offsetting mitigation of equal or greater long-term habitat benefits. All available steps shall be taken to prevent loss of habitat, and the Department shall oppose any development or project which will result in irreplaceable losses. Artificial production shall not be considered appropriate mitigation for loss of wild fish or their habitat.
- V. Sport fishing for sea-run steelhead shall be encouraged where the Department has determined that harvest will not harm existing wild populations. Harvest of juveniles shall only be permitted where such harvest does not impair adequate returns of adults for sport fishing and spawning. Special restrictions on the harvest of wild juvenile steelhead may be necessary when a fishery includes both wild and hatchery stocks.
- VI. Resident fish will not be planted or resident fisheries developed in drainages of steelhead waters, where, in the opinion of the Department, such planting or development will interfere with steelhead populations.
- VII. Exceptions to this policy may be made by the Commission (a) where the stream is no longer adaptable to anadromous runs, or (b) during the mid-summer period in those individual streams considered on a water-by-water basis where there is a high demand for angling recreation and such planting or development has been determined by the Department not to be detrimental to steelhead.

CALIFORNIA SALMONID STREAM HABITAT RESTORATION MANUAL

The following waters are excepted.

Nacimiento River	San Luis Obispo County
North Fork Battle Creek	Shasta County, upstream from Manton
Cow Creek	Shasta County upstream from Fern Road and Ingot
Antelope Creek	Tehama County, upstream from Ponderosa Way
Deer Creek	Tehama County, upstream from upper Deer Creek Falls
American River	Sacramento County, only in Arden Pond

TROUT

It is the policy of the Fish and Game Commission that:

- I. Natural reproduction and rearing of trout will be encouraged to the greatest extent possible by protecting and improving habitat and by affording protection from disease, predators and competing fish species.
- II. Populations of wild trout shall be sustained in suitable waters to provide a diversity of angling opportunities. In some waters it may be necessary to restrict angler harvest to the extent that such harvest has virtually no long-term effect on numbers and sizes of fish in the populations.
- III. Artificial propagation and rearing of trout is a major Department program, but will be utilized only when necessary to augment natural production. Stocking fingerling and sub-catchable-sized trout shall take priority over planting catchable-sized trout in the hatchery stocking program when the smaller fish will maintain satisfactory fishing.

Hatchery trout shall not be stocked in waters where they may compete or hybridize with trout which are threatened, endangered or species of special concern. Exceptions may be made for stocking waters which are not part of a species recovery program.

- IV. Catchable-sized trout shall be stocked only:
 - A. In lakes, reservoirs and streams where natural reproduction and growth are inadequate to maintain populations capable of supporting fishing; and
 - B. When it is reasonable to expect at least 50 percent by number or weight will be taken by anglers.

In stocking catchable-sized trout, lakes and larger streams shall have priority over smaller streams. Suitable waters with heavy fishing pressure compared to the size of planting allotments shall have priority. Trophy fish, weighing one pound or more may constitute up to 10 percent by weight of each load of catchables stocked, if they replace an equivalent poundage of catchables in the allotment for the water stocked.

CALIFORNIA SALMONID STREAM HABITAT RESTORATION MANUAL

- V. Sub-catchable-sized trout may be stocked in lakes, reservoirs and streams where appropriate to augment trout populations in such waters, and to increase fishing opportunities and success. Fingerlings shall be stocked primarily in waters where reproduction is limiting and satisfactory angling can be supported with fingerling stocking, where the population has been destroyed, and in lakes where they will establish a new fishery or augment the existing fishery.
- VI. Water companies, utility districts and other public or private agencies in control of urban lakes shall be encouraged to finance put-and-take trout fishing in such waters when suitable for such purposes. The Department shall provide technical advice and otherwise assist in the development and maintenance of such programs.

DEPARTMENT OF FISH AND GAME OPERATIONS MANUAL (POLICY)

Section 5220 - Importation of trout and salmon eggs.

Several serious fish diseases are known to be transmitted by eggs. The only treatment for some of these diseases is destruction of all infected fish. Because of the potential threat to broodstock, hatchery production, and wild fish, all trout and salmon or their eggs imported by the DFG from out-of-state will be sent to and retained at the Yountville Fish Facility until they have been certified disease-free by the Fish Disease Section. All importations of eggs must have prior written approval from the Division Chief.

Trout eggs exchanges or purchases for DFG hatcheries will be arranged by Inland Fisheries Division (IFD) subject to the following restrictions:

- a. Eggs may be imported only if the egg source has been tested by competent pathologists or hatchery biologists and are free of certain diseases. (See Section 5435, DFG Operations Manual);
- b. Eggs may not be purchased from so-called "egg brokers." These dealers obtain eggs from worldwide sources and it is impossible to maintain adequate checks on the condition of their eggs;
- c. Live salmon and trout and their eggs may not be imported into California from Idaho.

Section 5225 - Transfer of fish or eggs. Live fish and egg transfers between DFG facilities are considered during the January meeting of the Hatchery Operations Committee (HOC) (see Section 5210). All egg transfers within, or into, DFG hatchery system must be documented using form FG 701, "Records of Eggs Shipped and Received", transfers of eggs or fish into the system shall be coordinated by IFD with the approval of Pathology and the Division Chief.

Pathology approval (use Form FG 701A "Pathology Approval to Ship Eggs or Fish") shall be obtained at least 30 days prior to any proposed transfer of eggs or fish into the DFG hatchery system (see Fish Hatchery Operations Manual for more detail).

CALIFORNIA SALMONID STREAM HABITAT RESTORATION MANUAL

Trout and salmon eggs to be transferred within the DFG hatchery system which were not considered in the January fish production and allocation meeting of the HOC shall be coordinated by IFD and require Directorate approval.

Egg transfers may require special treatment by pathology to prevent disease transmittal. Special labeling/marketing of containers used for shipping may also be required.

Section 5240 - Cooperative rearing programs. The DFG may enter into agreements with counties, non-profit groups or private persons for management and operation of rearing facilities for salmon and steelhead (Fish and Game Code Sections 1200-1206). The Fish and Game Commission (FGC) policy supports the program, with restraints on its size and goals.

Section 5330 - Fingerling trout. Fingerling trout shall be utilized primarily to stock naturally barren waters, waters where the population has been destroyed, waters that have inadequate recruitment and lakes where fingerlings will provide an adequate fishery.

Fingerling trout shall be stocked pursuant to the approved annual regional trout allotments. Addition of any new water to the fingerling trout stocking program requires prior approval from the Division Chief.

Trout fingerlings surplus to existing allotments may be stocked in waters within reasonable distances from hatcheries where transportation costs are minimal, provided the waters have been previously planted. This is preferable to destroying such surplus fish.

Section 5335 - Sub-catchable trout. Sub-catchable trout shall be planted in waters with a potential for their growth. Sub-catchable trout shall be given priority over catchable trout when they can support all or a part of the fishery, and when expected costs of putting fish in the creek are less than that expected from catchable fish.

Sub-catchable trout shall be stocked pursuant to the approved annual regional trout allotments. Addition of any new water to the sub-catchable trout stocking program requires prior approval from the Division Chief.

Section 5340 - Catchable trout. Catchable trout shall be stocked only in heavily fished roadside lakes and streams where natural reproduction is inadequate to provide satisfactory fisheries. Exception may be made for special waters with approval of the Division Chief.

Waters shall not be stocked with catchable trout unless it is reasonable to expect that 50 percent or more of the stocked fish, by number or weight, will be taken by anglers.

Catchable trout shall be stocked pursuant to the approved annual regional trout allotments.

Addition of any new water to the catchable trout stocking program requires approval from the Division Chief.

Section 5355 - Temperature and flow criteria for catchable trout. Catchable trout shall not be stocked in streams when water temperatures reach 75^E Fahrenheit and it appears that such

CALIFORNIA SALMONID STREAM HABITAT RESTORATION MANUAL

temperatures will continue to occur regularly or when stream flows drop below 10 cubic feet per second (cfs). The exception is that suitable streams with flows between 2 and 10 cfs may be planted if water temperatures do not exceed 70^E Fahrenheit and other conditions are satisfactory. Stocking shall be discontinued if conditions are unsuitable because of shallow water, lack of pools, growth of algae, poor water quality, or other reasons.

Catchable trout shall not be stocked in lakes or reservoirs after surface water temperatures reach 78^E Fahrenheit and it appears that such temperatures will continue to occur regularly, nor after a trout die-off is attributed in whole or in part to an oxygen deficiency. Stocking shall be discontinued if algae blooms, aquatic weed growth, high turbidity, high alkalinity, or other conditions render the lake unsuitable for catchable trout or for fishing.

Catchable trout shall not be stocked in lakes or reservoirs until water temperatures reach 42^E Fahrenheit or higher most afternoons, or in streams until water temperatures reach 45^E Fahrenheit or higher most afternoons.

Catchable trout stocking may be suspended in reservoirs during periods of spill in order to avoid losses of planted fish to downstream areas where trout may not be readily available to anglers.

Section 5360 - Native anadromous salmon and trout in inland waters. Anadromous salmon or trout from sources within the state may not be stocked in inland waters without prior approval of the Deputy Director for Fisheries. This stocking may be done only if the fish are surplus to the needs of the regular stocking program.

Section 5365 - Native anadromous salmon and trout in anadromous waters. Serious problems occur in several drainages in California. To prevent the spread of these diseases, restrictions on movement of fish between drainages are necessary. It is also important to protect the genetic integrity of fish in several drainages that have been relatively unaffected by past stockings.

A policy is now being developed to address these problems. In the meantime, all movement of fish between drainages must have prior written approval of the Division Chief.

Section 5370 - Time and size of planting anadromous salmon and trout. Causal relationships have been established between survival and size of fish at release and the timing of release. Following are guidelines to be used in size of release and timing of release for chinook salmon, coho salmon, and steelhead trout from DFG hatcheries and cooperative rearing facilities.

- a. **Chinook salmon.** Chinook salmon will normally be held until they reach at least 90/lb. Central Valley fall-run chinook stocks usually attain this size about May 1. Exceptions must be approved by the Division Chief.

Chinook salmon reared to yearlings normally reach a size of 8 to 12/lb. in October and should be released before November 1st.

CALIFORNIA SALMONID STREAM HABITAT RESTORATION MANUAL

- b. **Coho salmon and steelhead trout.** Coho salmon should range from 10 to 20/lb. and steelhead trout should be at least 10/lb. at the time of release. The time period for release of coho salmon and steelhead trout is only between March 15 and May 1 except with approval of the Division Chief.

Section 5430 - Private stocking of anadromous fish. Under authority of Section 15900 of the Fish and Game Code, the Fish and Game Commission may grant a permit to a registered aquaculturist to rear and stock anadromous fish in State waters (ocean ranching). Regulations covering this activity are contained in Section 15901-15908 of the code, and Section 235.2 of Title 14.

Permits are issued by Wildlife Protection Division after approval is given by the FGC. All stocking of fish under this permit must have advance approval of the DFG.

CALIFORNIA SALMONID STREAM HABITAT RESTORATION MANUAL

APPENDIX C.

HYDROLOGIC BASIN PLANNING MAPS

Hydrologic unit boundaries are displayed on a series of 12 hydrologic basin maps for California at a scale of 1 to 500,000. Each map is based upon a Hydrologic Basin Planning Area. These maps may be used for: geocoding water-related data for computer storage and retrieval, such as sampling stations, sewage treatment facilities, industrial dischargers, stream flows, and water quality and aquatic tissue monitoring data; water quantity/quality problem (pollution) identification and control; and coordinating water resource planning. The 12 hydrologic basins are:

North Coast (NC)	Tulare Lake (TL)
San Francisco Bay (SF)	North Lahontan (NL)
Central Coast (CC)	South Lahontan (SL)
Los Angeles (LA)	Colorado River (CR)
Sacramento (SB)	Santa Ana (SA)
San Joaquin (SJ)	San Diego (SD)

These basins are surface water drainage areas, with some minor adjustments and follow Regional Board boundaries and the previously defined DWR hydrologic study areas.

State Board and DWR hydrologic boundaries are now congruent at all four levels (basin, unit, area, and subarea) of the hierarchy. The numbering systems for the areas are different, but the names and areas are identical. The state hydrologic boundaries are correlated with, and allow use of, a number of State Board, Regional Board, and other State agencies' mapping systems and/or associated databases. The State Board and DWR have agreed to use different numbering (coding) systems for the hydrologic hierarchy, but the two coding systems are related and have been documented in a reference computer file.

The numbering system used in the USGS hydrologic hierarchy is different than the State systems, but has been referenced to the State numbering systems in the same computer file noted above. This correlation between coding systems allows an interchange among mapping databases at the State and Federal level.

To obtain copies of the hydrologic basin planning area maps:

Chief, Surveillance and Monitoring Unit
Division of Water Quality
State Water Resources Control Board
P.O. Box 100
Sacramento, California 95801

CALIFORNIA SALMONID STREAM HABITAT RESTORATION MANUAL

APPENDIX D.

AERIAL PHOTO SOURCES

One of the best initial contacts for researching aerial photography and related information is the Earth Science Information Center (ESIC), operated by the U.S. Geologic Survey (USGS). For example, ESIC's Aerial Photography Summary Record System identifies over 130 California sources of aerial photography, public and private. In addition to the California office in Menlo Park, ESIC also maintains liaisons with the State Agencies listed below.

Another good source is the aerial photo "clearing house" for the U.S. Department of Agriculture (USDA) and the Agriculture Stabilization and Conservation Service (ASCS). The ASCS can provide photo indexes and hard copies of current and historical aerial photography, as well as information on in-progress and planned aerial photo missions by the federal agencies. Allow four to six weeks for delivery. Private sources have quicker turn-around times (some offer overnight service), but prices for typical products (9 x 9 contact prints or simple enlargements) are substantially higher than federal and state sources.

FEDERAL ESIC

USGS
Earth Science Information Center
345 Middlefield Rd.
MS 532
Menlo Park, CA 94025
(415) 329-4309

NASA Ames Research Center
Aircraft Data Facility
MS 240-12; Bldg 240, Room 219
Moffet Field, CA 94035-1000
(415) 604-6252

OTHER FEDERAL AGENCIES

U.S. Department of Agriculture
Agricultural Stabilization &
Conservation Service
Aerial Photography Field Office
P.O. Box 30010
Salt Lake City, UT 84130
(801) 975-3503

U.S. Forest Service
Region 5 Office
630 Sansome Street
San Francisco, CA 94111
(415) 705-2836

U.S. Department of Interior
Bureau of Reclamation
Mid-Pacific Region
2800 Cottage Way, Room W1324
Sacramento, CA 95825
(916) 978-5010

U.S. Environmental Protection Agency
Environmental Sciences Division
Landscape Ecology Branch
P.O. Box 93478
Las Vegas, NV 89193-3478
(702) 798-2100

CALIFORNIA SALMONID STREAM HABITAT RESTORATION MANUAL

U.S. Army Corps of Engineers
Regulatory Functions Branch
333 Market St. 8th Floor
San Francisco, CA 94105
(415) 977-8462

U.S. Army Corps of Engineers
Survey Branch, Sacramento District
1325 J St
Sacramento, CA 95814-2922
(916) 557-7158

U.S. Department of Interior
Bureau of Indian Affairs
Sacramento Office, Br. Of Land Operations
2800 Cottage Way, Room W2550
Sacramento, CA 95825
(916) 979-2600

U.S. Geological Survey
EROS Data Center
Sioux Falls, SD 57148
(605) 594-6151

U.S. Army Corps of Engineers
Survey Branch, Los Angeles District
645 Durfee Ave
El Monte, CA 91733
(818) 401-4009

U.S. Geological Survey
Western Mapping Center
345 Middlefield Rd
Menlo Park, CA 94025
(650) 853-8300

STATE ESIC AGENCIES

OTHER STATE AGENCIES

California Department of Conservation
Division of Mines and Geology
Information Office
801 K Street, MS 12-30
Sacramento, CA 95814-3532
(916) 445-1825

CALTRANS
Division of Highways, Photogrammetry Br.
1120 N St., MS 35
Sacramento, CA 95814
(916) 227-7680

Library, Map Collection
San Diego State University
San Diego, CA 92182-0511
(619) 594-5832
(916) 653-4881
Map and Imagery Laboratory
Davidson Library University of California Santa Barbara
Santa Barbara, CA 93106
(805) 893-2779

CA Department of Water Resources
1416 9th St.
P.O. Box 942836
Sacramento, CA 94236-9257

COUNTY AGENCIES

County assessors, planners, and public works departments often have historical aerial and other photography used for timber tax assessment or early land surveys.

CALIFORNIA SALMONID STREAM HABITAT RESTORATION MANUAL

PRIVATE FIRMS

A selection of firms serving California and other western states is provided below. Additionally, ESIC=s Aerial Photography Summary Record System for address and phone numbers of all organizations which contribute photo archive information.

Richard B. Davis Company
140 Rowdy Creek Rd
Smith River, CA 95567
(707) 487-6277

PDS
1090 Bailey Hill Rd. Suite E
Eugene, OR 97402
(541) 343-8877

Pacific Aerial Surveys
8407 Edgewater Dr
Oakland, CA 94621-1403
(510) 632-2020

Aerial Data Systems
990 Klamath Lane, Suite 18
Yuba City, CA 95993-8962
(530) 673-1430

WAC Corporation
520 Conger Street
Eugene, OR 97402
(800) 845-8088
(541) 342-5169

Aerial Photomapping Services
2929 Larkin Ave.
Clovis, CA 93612
(209) 291-0147

Chase Jones
1500 S. W. 12th Avenue
Portland, OR 97201
(503) 228-9844

I. K. Curtis Services, Inc.
2901 Empire Avenue
Burbank, CA 91504
(818) 842-5127

CALIFORNIA SALMONID STREAM HABITAT RESTORATION MANUAL

APPENDIX E.

LIST OF CALIFORNIA FISH SPECIES

The California Department of Fish and Game uses the following standardized abbreviations for aquatic species found in California.

<u>Variety</u>	<u>Abbreviation</u>
Lamprey	LP
White sturgeon	WST
Green sturgeon	GST
American shad	AS
Threadfin shad	TFS
Freshwater smelt	FS
Delta smelt	DS
Mountain whitefish	WF
Salmon	
Pink salmon	PINK
Chum salmon	CHUM
Coho salmon	COHO
Chinook salmon	CHIN
Sockeye salmon	SOCK
Kokanee salmon	KOK
Trout	
Brown trout	BN
Cutthroat trout	CT
Coast cutthroat trout	CT-C
Lahontan cutthroat trout	CT-L
Paiute cutthroat trout	CT-P
Rainbow trout	RT
Steelhead rainbow trout	SH
Coleman stock	RT-C
Kamloops rainbow trout	RT-K
Junction Kamloops stock	RT-KJ
Hot Creek stock	RT-H
Mt. Shasta stock	RT-S
Mt. Whitney stock	RT-W
Pit River stock	RT-P
Eagle Lake trout	ELT

**CALIFORNIA SALMONID STREAM
HABITAT RESTORATION MANUAL**

<u>Variety</u>	<u>Abbreviation</u>
Golden trout	GT
Little Kern golden stock	GT-LK
South Fork Kern golden trout	GT-SF
Chars	
Brook trout	EB
San Joaquin stock	EB-SJ
Lake trout	LT
Arctic grayling	AG
Suckers	SKR
Owens sucker	SKR-O
Lost River sucker	SKR-LR
Modoc sucker	SKR-MO
Western sucker	SKR-W
Mountain sucker	SKR-MT
Klamath smallscale sucker	SKR-KS
Klamath largescale sucker	SKR-KL
Santa Ana sucker	SKR-SA
Tahoe sucker	SKR-T
Shortnose sucker	SKR-SN
Humpback sucker	SKR-H
Minnows	
Common carp	CP
Grass carp	GC
Goldfish	GF
Golden shiner	GSH
Sacramento blackfish	BLK
Hardhead	HH
Hitch	HCH
Squawfish	SQ
Colorado squawfish	SQ-C
Sacramento squawfish	SQ-S
Lahotan redbreast	LRS
Roach	RCH
Tui chub	TC
Dace	DC
Red shiner	PRS
Fathead minnow	FHM

**CALIFORNIA SALMONID STREAM
HABITAT RESTORATION MANUAL**

<u>Variety</u>	<u>Abbreviation</u>
Catfish	
Channel catfish	CCF
White catfish	WCF
Blue catfish	BCF
Flathead catfish	FCF
Brown bullhead	BB
Black bullhead	BLB
Yellow bullhead	YB
Mosquitofish	GAM
Molly	MOL
Inland silverside	IS
Striped bass	SB
White bass	WHB
Yellow perch	YP
Bigscale logperch	BLP
Sunfish	
Redeye bass	REB
Smallmouth bass	SMB
Spotted bass	SPB
Alabama spotted bass	SPB-A
Northern spotted bass	SPB-N
Largemouth bass	LMB
Northern largemouth bass	LMB-N
Florida largemouth bass	LMB-F
Warmouth	WB
Green sunfish	GSF
Pumpkinseed	PSD
Redear sunfish	RSF
Bluegill	BG
Northern bluegill	BG-N
Southeastern bluegill	BG-F
Sacramento perch	SP
White crappie	WCR
Black crappie	BCR
Northern Black crappie	BCR-N
Blacknose crappie	BCR-A
Florida black crappie	BCR-F

**CALIFORNIA SALMONID STREAM
HABITAT RESTORATION MANUAL**

<u>Variety</u>	<u>Abbreviation</u>
Tule perch	TP
Sculpin	SCP
Stickleback	STB
Striped mullet	MUL
Yellowfin goby	YFG
Longjaw mudsucker	LJM
Tilapia	TIL
Redbelly tilapia	TIL-Z
Mozambique tilapia	TIL-M
<u>Tilapia hornorum</u>	TIL-H
Pupfish	PUP
Bairdiella	BAR
Sargo	SAR
Orangemouth corvina	ORC
Crayfish	CF
Signal crayfish	PL
Shasta crayfish	PF
Red swamp crayfish	PC
<u>Orconectes virilis</u>	OV
Freshwater prawn (<u>Macrobrachium</u>)	MR
Asian clam (<u>Corbicula</u>)	COR

**CALIFORNIA SALMONID STREAM
HABITAT RESTORATION MANUAL**

APPENDIX F

**STATE AND FEDERAL ENDANGERED AND THREATENED SPECIES
ASSOCIATED WITH SALMONID HABITAT**

This is a list of the animals found within California or off the coast of the state that have been classified as Endangered or Threatened by the California Fish and Game Commission (state list) or by the U. S. Secretary of the Interior or the U. S. Secretary of Commerce (federal list).

The official California listing of Endangered and Threatened animals is contained in the California Code of Regulations, Title 14, Section 670.5. The official federal listing of Endangered and Threatened animals is published in the Federal Register, 50 CFR 17.11.

Animals that are candidates for state listing and animals proposed for federal listing are also included on this list. A state candidate species is one the Fish and Game Commission has formally noticed as being under review by the Department for addition to the state list. A federal proposed species is one for which a proposed regulation has been published in the Federal Register.

Code Designation: Totals as of October 2001

SE = State-listed Endangered	47
ST = State-listed Threatened.....	30
FE = Federally listed Endangered	77
FT = Federally listed Threatened.....	40
SCE = State candidate (Endangered).....	1
SCT = State candidate (Threatened).....	0
FPE = Federally proposed (Endangered).....	3
FPT = Federally proposed (Threatened).....	1
FPD = Federally proposed (Delisting).....	2
DE = Delisted.....	1

Common and scientific names are shown as they appear on the state or federal lists. If the nomenclature differs for a species that is included on both lists, the state nomenclature is given and the federal nomenclature is shown in a footnote. Synonyms, names changes, and other clarifying points are also footnoted.

Critical Habitat is defined in Section 3 of the federal Endangered Species Act as specific areas, both occupied and unoccupied, that is essential to the conservation of a listed species and that may require special management considerations or protection.

Recovery Plans are discussed in Section 4 of the federal Endangered Species Act. Each plan incorporates site-specific management actions necessary for the conservation and survival of the species.

The “List Date” for final federal listing and final Critical Habitat designation (Desig.) is the date the listing or designation becomes effective, this is usually not the date of publication of the rule in the Federal Register, it is usually 30 days after publication.

Codes designation for Critical Habitat and Recovery Plans:

**CALIFORNIA SALMONID STREAM
HABITAT RESTORATION MANUAL**

F= Final
P= Proposed
R= Revised

Changes to this update of the list are denoted by *

	State	Listing Status		Designation	Critical Habitat	Recovery Plan		
		List Date	Federal		List Date	Date	Version	Date
<u>GASTROPODS</u>								
Trinity bristle snail (<i>Monadenia setosa</i>)	ST ¹	10-02-80						
Morro shoulderband (= banded dune) snail (<i>Helminthoglypta walkeriana</i>)			FE	1-17-95	F	3-9-01	F	1998
White abalone (<i>Haliotis sorenseni</i>)			FE	6-28-01				
<u>CRUSTACEANS</u>								
Riverside fairy shrimp (<i>Streptocephalus woottoni</i>)			FE	8-3-93	F	6-29-01	F	1998
Conservancy fairy shrimp (<i>Branchinecta conservatio</i>)			FE	9-19-94				
Longhorn fairy shrimp (<i>Branchinecta longiantenna</i>)			FE	9-19-94				
Vernal pool fairy shrimp (<i>Branchinecta lynchi</i>)			FT	9-19-94				
San Diego fairy shrimp (<i>Branchinecta sandiegoensis</i>)			FE	2-3-97	F	10-23-00	F	1998
Vernal pool tadpole shrimp (<i>Lepidurus packardi</i>)			FE	9-19-94				

¹ On January 1, 1985, all species designated as "rare" were reclassified as "threatened", as stipulated by the California Endangered Species Act.

**CALIFORNIA SALMONID STREAM
HABITAT RESTORATION MANUAL**

	Listing Status				Critical Habitat	Recovery Plan		
	State	List Date	Federal	List Date	Designation	Date	Version	Date
Shasta crayfish ² (<i>Pacifastacus fortis</i>)	SE	2-26-88	FE	9-30-88			F	1998
California freshwater shrimp (<i>Syncaris pacifica</i>)	SE	10-2-80	FE	10-31-88			F	1998
<u>INSECTS</u>								
Zayante band-winged grasshopper (<i>Trimerotropis infantilis</i>)			FE	2-24-97	F	3-9-01	F	1998
Mount Hermon June beetle (<i>Polyphylla barbata</i>)			FE	2-24-97			F	1998
Delta green ground beetle (<i>Elaphrus viridis</i>)			FT	8-8-80	F	8-8-80	F	1985
Valley elderberry longhorn beetle (<i>Desmocerus californicus dimorphus</i>)			FT	8-8-80	F	8-8-80	F	1984
Ohlone tiger beetle (<i>Cicindela ohlone</i>)			FE	10-3-01				
Kern primrose sphinx moth (<i>Euproserpinus euterpe</i>)			FT	4-8-80	P	7-3-78		
Mission blue butterfly (<i>Icaricia icarioides missionensis</i>)			FE	6-1-76	P	2-8-77	F	1984
Lotis blue butterfly (<i>Lycaeides argyrognomon lotis</i>)			FE	6-1-76	P	2-8-77	F	1985
Palos Verdes blue butterfly (<i>Glaucopsyche lydamus palosverdesensis</i>)			FE	7-2-80	F	7-2-80	F	1984

² Federal: Shasta (=placid) crayfish

**CALIFORNIA SALMONID STREAM
HABITAT RESTORATION MANUAL**

	Listing Status			Designation	Critical Habitat	Recovery Plan	
	State	Federal	List Date		Date	Version	Date
El Segundo blue butterfly (<i>Euphilotes battoides allyni</i>)		FE	6-1-76	P	2-8-77	F	1998
Smith's blue butterfly (<i>Euphilotes enoptes smithi</i>)		FE	6-1-76	P	2-8-77	F	1984
San Bruno elfin butterfly (<i>Incisalia mossii bayensis</i> ³)		FE	6-1-76	P	2-8-77	F	1984
Lange's metalmark butterfly (<i>Apodemia mormo langei</i>)		FE	6-1-76	P	2-8-77	R	1984
Bay checkerspot butterfly (<i>Euphydryas editha bayensis</i>)		FT	10-18-87	P	10-16-00	F	1998
Quino checkerspot (<i>Euphydryas editha quino</i>)		FE	1-16-97	P	2-7-01		
Laguna Mountains skipper (<i>Pyrgus ruralis lagunae</i>)		FE	1-16-97				
Callippe silverspot butterfly (<i>Speyeria callippe callippe</i>)		FE	12-5-97	P	3-28-80		
Behren's silverspot butterfly (<i>Speyeria zerene behrensii</i>)		FE	12-5-97				
Oregon silverspot butterfly (<i>Speyeria zerene hippolyta</i>)		FT	7-2-80	F	7-2-80		

³ Federal: *Callophrys, mossi bayensis*

**CALIFORNIA SALMONID STREAM
HABITAT RESTORATION MANUAL**

	Listing Status			Designation	Critical Habitat	Recovery Plan	
	State	List Date	Federal		List Date	Date	Version
Myrtle's silverspot butterfly (<i>Speyeria zerene myrtleae</i>)			FE	6-22-92			F 1998
Delhi Sands flower-loving fly (<i>Rhaphiomidas terminatus abdominalis</i>)			FE	9-23-93			F 1997
<u>FISHES</u>							
Winter-run chinook salmon ⁴ (<i>Oncorhynchus tshawytscha</i>)	SE	9-22-89	FE	2-3-94	F		3-23-99
Chinook salmon-California coastal ESU ⁵ (<i>Oncorhynchus tshawytscha</i>)			FT ⁶	11-15-99	F		2-16-00
Spring-run chinook salmon (<i>Oncorhynchus tshawytscha</i>)	ST	2-5-99	FT ⁷	11-15-99	F		2-16-00
Coho salmon-Central Calif Coast ESU (<i>Oncorhynchus kisutch</i>)	SE ⁸ SE ⁹	12-31-95 8-30-02	FT ¹⁰	12-2-96			

⁴ Federal: Sacramento River winter run chinook salmon

⁵ ESU= Evolutionarily Significant Unit

⁶ Naturally spawned coastal spring & fall Chinook salmon between Redwood Creek in Humboldt Co. & the Russian River in Sonoma Co.

⁷ Federal: Central Valley Spring-Run ESU. Includes populations spawning in the Sacramento River & its tributaries

⁸ The state listing is limited to coho south of San Francisco Bay.

⁹ The state endangered listing includes populations south of Punta Gorda.

¹⁰ The federal listing is limited to naturally spawning populations in streams between Punta Gorda, Humboldt Co. & the San Lorenzo River, Santa Cruz Co.

**CALIFORNIA SALMONID STREAM
HABITAT RESTORATION MANUAL**

	Listing Status			Critical Habitat	Recovery Plan			
	State	List Date	Federal	List Date	Designation	Date	Version	Date
Coho salmon-So. Oregon/No. Calif ESU ¹¹ (<i>Oncorhynchus kisutch</i>)	ST ¹²	8-30-02	FT	6-5-97	F	3-17-00		
Little Kern golden trout (<i>Oncorhynchus mykiss whitei</i>) ¹³			FT	4-13-78	F	4-13-78		
Lahontan cutthroat trout (<i>Oncorhynchus clarki henshawi</i>) ¹⁴			FT	7-16-75	F	1995		
Paiute cutthroat trout (<i>Oncorhynchus clarki seleniris</i>) ¹⁵			FT FE	7-16-75 3-11-67				
Steelhead-Northern California ESU ¹⁶ (<i>Oncorhynchus mykiss</i>)			FT	8-7-00				
Steelhead-Central California Coast ESU ¹⁷ (<i>Oncorhynchus mykiss</i>)			FT	10-17-97	F	3-17-00		
Steelhead-South/Central California Coast ESU ¹⁸ (<i>Oncorhynchus mykiss</i>)			FT	10-17-97	F	3-17-00		

¹¹ Populations between Cape Blanco, Oregon & Punta Gorda, California.

¹² The federal listing includes populations between Cape Blanco Oregon, & Punta Gorda. The state threatened listing includes populations north of Punta Gorda.

¹³ Federal: *Oncorhynchus* (=Salmon) *aguabonita whitei*

¹⁴ Federal: *Oncorhynchus* (=Salmo) *clarki henshawi*

¹⁵ Federal: *Oncorhynchus* (=Salmo) *clarki seleniris*

¹⁶ Naturally spawned populations residing below impassable barriers in coastal basins from Redwood Creek in Humboldt Co. to, and including, the Gualala River in Mendocino Co.

¹⁷ Coastal basins from the Russian River, south to Soquel Creek, inclusive. Includes the San Francisco & San Pablo Bay basins, but excludes the Sacramento-San Joaquin River basins.

¹⁸ Coastal basins from the Pajaro River south to, but not including, the Santa Maria River.

**CALIFORNIA SALMONID STREAM
HABITAT RESTORATION MANUAL**

	Listing Status			Designation	Critical Habitat	Recovery Plan		
	State	List Date	Federal		List Date	Date	Version	Date
Steelhead-Southern California ESU ¹⁹ (<i>Oncorhynchus mykiss</i>)			FT	10-17-97	F	3-17-00		
Steelhead-Central Valley ESU ²⁰ (<i>Oncorhynchus mykiss</i>)			FT	5-18-98	F	3-17-00		
Bull trout (<i>Salvelinus confluentus</i>)	SE	10-2-80	FT	12-1-99				
Delta smelt (<i>Hypomesus transpacificus</i>)	ST	12-9-93	FT	3-5-93	F	12-19-94	F	1996
Mohave tui chub (<i>Gila bicolor mohavensis</i>)	SE	6-27-71	FE	10-13-70			F	1984
Owens tui chub (<i>Gila bicolor snyderi</i>)	SE	1-10-74	FE	8-5-85	F	8-5-85	F	1998
Cowhead Lake tui chub (<i>Gila bicolor vaccaceps</i>)			FPE	3-30-98				
Bonytail ²¹ (<i>Gila elegans</i>)	SE SR	1-10-74 6-27-71	FE	4-23-80	F	3-21-94	R	1990
Sacramento splittail (<i>Pogonichthys macrolepidotus</i>)			FT	3-10-99			F	1996
Colorado squawfish ²² (<i>Ptychocheilus lucius</i>)	SE	6-27-71	FE	3-11-67	F	3-21-94	R	1991
Lost River sucker (<i>Deltistes luxatus</i>)	SE SR	1-10-74 6-27-71	FE	7-18-88	P	12-1-94	F	1993
Modoc sucker (<i>Catostomus microps</i>)	SE SR	10-2-80 1-10-74	FE	6-11-85	F	6-11-85		

¹⁹ Coastal basins from the Santa Maria River, south to the southern extent of the range (presently considered to be Malibu Creek. Proposed rulemaking 12-19-2000 to extend to southern portion of the range to San Mateo Creek in San Diego Co.).

²⁰ The Sacramento and San Joaquin Rivers and their tributaries.

²¹ Federal: Bonytail chub

²² Current nomenclature and federal listing: Colorado pikeminnow

**CALIFORNIA SALMONID STREAM
HABITAT RESTORATION MANUAL**

	Listing Status			Designation	Critical Habitat	Recovery Plan	
	State	List Date	Federal		List Date	Date	Version
Santa Ana sucker (<i>Catostomus santaanae</i>)			FT	5-12-00			
Shortnose sucker (<i>Chasmistes brevirostris</i>)	SE SR	1-10-74 6-27-71	FE	7-18-8	P	12-1-94	F 1993
Razorback sucker (<i>Xyrauchen texanus</i>)	SE SR	1-10-74 6-27-71	FE	10-23-91	F	3-21-94	
Desert pupfish (<i>Cyprinodon macularius</i>)	SE	10-2-80	FE	3-31-86	F	3-31-86	F 1993
Cottonball Marsh pupfish (<i>Cyprinodon salinus milleri</i>)	ST	1-10-74					
Owens pupfish (<i>Cyprinodon radiosus</i>)	SE	6-27-71	FE	3-11-67			F 1998
Unarmored threespine stickleback (<i>Gasterosteus aculeatus williamsoni</i>)	SE	6-27-71	FE	10-13-70	P	11-17-80	F 1985
Tidewater goby (<i>Eucyclogobius newberryi</i>)			FPD ₂₃ FE	6-24-99 2-4-94	F	11-20-00	
Rough sculpin (<i>Cottus asperrimus</i>)	ST	1-10-74					

AMPHIBIANS

Calif. tiger salamander - Santa Barbara Co. DPS ²⁴ (<i>Ambystoma californiense</i>)			FE ²⁵	9-15-00			
---	--	--	------------------	---------	--	--	--

²³ Proposal to delist refers to populations north of Orange County only.

²⁴ DPS= Distinct Vertebrate Population Segment

²⁵ Federal listing refers to the Santa Barbara County DPS only.

**CALIFORNIA SALMONID STREAM
HABITAT RESTORATION MANUAL**

	Listing Status			Designation	Critical Habitat	Recovery Plan		
	State	List Date	Federal		List Date	Date	Version	Date
Santa Cruz long-toed salamander (<i>Ambystoma macrodactylum croceum</i>)	SE	6-27-71	FE	3-11-67	P	6-22-78	D	1999
Siskiyou Mountains salamander (<i>Plethodon stormi</i>)	ST	6-27-71						
Tehachapi slender salamander (<i>Batrachoseps stebbinsi</i>)	ST	6-27-71						
Kern Canyon slender salamander (<i>Batrachoseps simatus</i>)	ST	6-27-71						
Desert slender salamander (<i>Batrachoseps aridus</i>) ²⁶	SE	6-27-71	FE	6-4-73			F	1982
Shasta salamander (<i>Hydromantes shastae</i>)	ST	6-27-71						
Limestone salamander (<i>Hydromantes brunus</i>)	ST	6-27-71						
Black toad (<i>Bufo exsul</i>)	ST	6-27-71						
Arroyo toad ²⁷ (<i>Bufo californicus</i>)			FE	1-17-95	F	3-9-01	F	1999
California red-legged frog (<i>Rana aurora draytonii</i>)			FT ²⁸	5-20-96	F	4-12-01	D	2000

²⁶ Current taxonomy: *Batrachoseps major aridus*

²⁷ Former taxonomy: *Bufo microscaphus californicus*

²⁸ Federal listing does not include Humboldt, Trinity, and Mendocino Counties; Glenn, Lake & Sonoma Counties west of the Central Valley hydrologic Basin; Sonoma Creek & Petaluma River drainages which flow into San Francisco Bay, & north of the Walker Creek drainage which flows to the Pacific Ocean

**CALIFORNIA SALMONID STREAM
HABITAT RESTORATION MANUAL**

	Listing Status			Designation	Critical Habitat	Recovery Plan		
	State	List Date	Federal		List Date	Date	Version	Date
Mountain yellow-legged frog - So. Calif. Pop. ²⁹ (<i>Rana muscosa</i>)			FPE	12-28-99				
<u>REPTILES</u>								
Desert tortoise (<i>Gopherus agassizii</i>)	ST	8-3-89	FT	4-2-90	F	2-8-94	F	1994
Green sea turtle (<i>Chelonia mydas</i>)			FT FE	7-28-78 10-13-70	F	3-23-99	R	1998
Loggerhead sea turtle (<i>Caretta caretta</i>)			FT	7-28-78	P	3-19-80	R	1998
Olive (=Pacific) Ridley sea turtle (<i>Lepidochelys olivacea</i>)			FT	7-28-78	P	3-19-80	R	1998
Leatherback sea turtle (<i>Dermochelys coriacea</i>)			FE	6-2-70	F	3-23-99	R	1998
Barefoot banded gecko ³⁰ (<i>Coleonyx switaki</i>)	ST	10-2-80						
Coachella Valley fringe-toed lizard (<i>Uma inornata</i>)	SE	10-2-80	FT	9-25-80	F	9-25-80	F	1984
Blunt-nosed leopard lizard (<i>Gambelia silus</i>) ³¹	SE	6-27-71	FT	3-11-67			F	1998
Island night lizard (<i>Xantusia riversiana</i>)			FT	8-11-67			F	1984
Southern rubber boa (<i>Charina bottae umbratica</i>)	ST	6-27-71						
Alameda whipsnake (<i>Masticophis lateralis euryxanthus</i>)	ST	6-27-71	FT	12-5-97	F	10-3-00		
San Francisco garter snake (<i>Thamnophis sirtalis tetrataenia</i>)	SE	6-27-71	FE	3-11-67			F	1985

²⁹ Federal listing proposal refers to populations in the San Gabriel, San Jacinto & San Bernardino Mountains only.

³⁰ Current nomenclature: Barefoot gecko

³¹ Current taxonomy: *Gambelia sila*

**CALIFORNIA SALMONID STREAM
HABITAT RESTORATION MANUAL**

	Listing Status				Critical Habitat	Recovery Plan		
	State	List Date	Federal	List Date	Designation	Date	Version	Date
Giant garter snake (<i>Thamnophis couchi gigas</i>) ³²	ST	6-27-71	FT	10-20-93			D	1999
<u>BIRDS</u>								
Short-tailed albatross (<i>Phoebastria albatrus</i>)			FE	8-30-00				
California brown pelican ³³ (<i>Pelecanus occidentalis californicus</i>)	SE	6-27-71	FE	10-13-70			F	1983
California condor (<i>Gymnogyps californianus</i>)	SE	6-27-71	FE	3-11-67	F	9-22-77	R	1996
Bald eagle (<i>Haliaeetus leucocephalus</i>)	SE (rev) SE	10-2-80	FPD FT FE (rev) FE	7-6-99 8-11-95 2-14-78 3-11-67				
Swainson's hawk (<i>Buteo swainsoni</i>)	ST	4-17-83						
American peregrine falcon (<i>Falco peregrinus anatum</i>)	SE	6-27-71	DE FE	8-25-99 10-13-70	F	9-22-77	F	1982
California black rail (<i>Laterallus jamaicensis coturniculus</i>)	ST	6-27-71						
California clapper rail (<i>Rallus longirostris obsoletus</i>)	SE	6-27-71	FE	10-13-70			F	1984
Light-footed clapper rail (<i>Rallus longirostris levipes</i>)	SE	6-27-71	FE	10-13-70			F	1979

³² Current taxonomy and federal listing: *Thamnophis gigas*

³³ Federal: Brown pelican, *Pelecanus occidentalis*

**CALIFORNIA SALMONID STREAM
HABITAT RESTORATION MANUAL**

	Listing Status			Designation	Critical Habitat	Recovery Plan	
	State	List Date	Federal		List Date	Date	Version
Yuma clapper rail (<i>Rallus longirostris</i> <i>yumanensis</i>)	ST	2-22-78	FE	3-11-67		F	1983
Greater sandhill crane (<i>Grus canadensis</i> <i>tabida</i>)	ST	4-17-83					
Western snowy plover ³⁴ (<i>Charadrius</i> <i>alexandrinus nivosus</i>)			FT	4-5-93	F	12-7-99	
Mountain plover (<i>Charadrius</i> <i>montanus</i>)			FPT	2-16-99			
California least tern (<i>Sterna antillarum</i> <i>browni</i>)	SE	6-27-71	FE	10-13-70		F	1980
Marbled murrelet (<i>Brachyramphus</i> <i>marmoratus</i>) ³⁵	SE	3-12-92	FT	9-30-92	F	5-24-96	F 1997
Western yellow- billed cuckoo (<i>Coccyzus</i> <i>americanus</i> <i>occidentalis</i>)	SE ST	3-26-88 6-27-71					
Elf owl (<i>Micrathene</i> <i>whitneyi</i>)	SE	10-2-80					
Northern spotted owl (<i>Strix occidentalis</i> <i>caurina</i>)			FT	6-22-90	F	1-15-92	
Great gray owl (<i>Strix nebulosa</i>)	SE	10-2-80					
Gila woodpecker (<i>Melanerpes</i> <i>uropygialis</i>)	SE	3-17-88					
Gilded northern flicker ³⁶ (<i>Colaptes auratus</i> <i>chrysoides</i>)	SE	3-17-88					

³⁴ Federal status applies only to the Pacific coastal population.

³⁵ Federal: *Brachyramphus marmoratus marmoratus*

³⁶ Current taxonomy: Gilded flicker (*Colaptes chrysoides*)

**CALIFORNIA SALMONID STREAM
HABITAT RESTORATION MANUAL**

	Listing Status			Critical Habitat	Recovery Plan			
	State	List Date	Federal	List Date	Designation	Date	Version	Date
Willow flycatcher (<i>Empidonax traillii</i>)	SE ³⁷	1-2-91						
Southwestern willow flycatcher (<i>Empidonax traillii extimus</i>)			FE	3-29-95	F	7-22-97	D	2001
Bank swallow (<i>Riparia riparia</i>)	ST	6-11-89						
Coastal California gnatcatcher (<i>Polioptila californica californica</i>)			FT	3-30-93	F	10-24-00		
San Clemente loggerhead shrike (<i>Lanius ludovicianus mearnsi</i>)			FE	8-11-77			F	1984
Arizona Bell's vireo (<i>Vireo bellii arizonae</i>)	SE	3-17-88						
Least Bell's vireo (<i>Vireo bellii pusillus</i>)	SE	10-2-80	FE	5-2-86	F	2-2-94	D	1998
Inyo California towhee ³⁸ (<i>Pipilo crissalis eremophilus</i>)	SE	10-2-80	FT	8-3-87	F	8-3-87	F	1998
San Clemente sage sparrow (<i>Amphispiza belli clementeae</i>)			FT	8-11-77			F	1984
Belding's savannah sparrow (<i>Passerculus sandwichensis beldingi</i>)	SE	1-10-74						

MAMMALS

³⁷ State listing includes all subspecies

³⁸ Federal: Inyo California (=brown) towhee

**CALIFORNIA SALMONID STREAM
HABITAT RESTORATION MANUAL**

	Listing Status			Designation	Critical Habitat	Recovery Plan		
	State	List Date	Federal		List Date	Date	Version	Date
Buena Vista Lake shrew (<i>Sorex ornatus relictus</i>)			FPE	6-1-00			F	1998
Riparian brush rabbit (<i>Sylvilagus bachmani riparius</i>)	SE	5-29-94	FE	3-24-00			F	1998
Point Arena mountain beaver (<i>Aplodontia rufa nigra</i>)			FE	12-12-91			F	1998
San Joaquin antelope squirrel (<i>Ammospermophilus nelsoni</i>)	ST	10-2-80						
Mohave ground squirrel (<i>Spermophilus mohavensis</i>)	ST	6-27-71						
Pacific pocket mouse (<i>Perognathus longimembris pacificus</i>)			FE	9-26-94			F	1998
Morro Bay kangaroo rat (<i>Dipodomys heermanni morroensis</i>)	SE	6-27-71	FE	10-13-70	F	8-11-77	F	1982
Giant kangaroo rat (<i>Dipodomys ingens</i>)	SE	10-2-80	FE	1-5-87			F	1998
Stephens' kangaroo rat (<i>Dipodomys stephensi</i>) ³⁹	ST	6-27-71	FE	9-30-88				
San Bernardino kangaroo rat (<i>Dipodomys merriami parvus</i>)			FE	9-24-98	P	12-8-00		

³⁹ Federal: includes *Dipodomys cascus*

**CALIFORNIA SALMONID STREAM
HABITAT RESTORATION MANUAL**

	Listing Status				Critical Habitat	Recovery Plan		
	State	List Date	Federal	List Date	Designation	Date	Version	Date
Tipton kangaroo rat (<i>Dipodomys nitratoides nitratoides</i>)	SE	6-11-89	FE	7-8-88			F	1998
Fresno kangaroo rat (<i>Dipodomys nitratoides exilis</i>)	SE SR	10-2-80 6-27-71	FE	3-1-85	F	1-30-85	F	1998
Salt-marsh harvest mouse (<i>Reithrodontomys raviventris</i>)	SE	6-27-71	FE	10-13-70			F	1984
Amargosa vole (<i>Microtus californicus scirpensis</i>)	SE	10-2-80	FE	11-15-84	F	1-15-84	F	1997
Riparian woodrat (<i>Neotoma fuscipes riparia</i>)			FE	3-24-00				
Sierra Nevada red fox (<i>Vulpes vulpes necator</i>)	ST	10-2-80						
San Joaquin kit fox (<i>Vulpes macrotis mutica</i>)	ST	6-27-71	FE	3-11-67			F	1998
Island fox (<i>Urocyon littoralis</i>)	ST	6-27-71						
Guadalupe fur seal (<i>Arctocephalus townsendi</i>)	ST	6-27-71	FT	12-16-85				
Steller (=northern) sea lion (<i>Eumetopias jubatus</i>)			FT	4-5-90	F	3-23-99		
Wolverine (<i>Gulo gulo</i>)	ST	6-27-71						
Southern sea otter (<i>Enhydra lutris nereis</i>)			FT	1-14-77			F	1981
Sei whale (<i>Balaenoptera borealis</i>)			FE	6-2-70				

**CALIFORNIA SALMONID STREAM
HABITAT RESTORATION MANUAL**

	Listing Status			Designation	Critical Habitat	Recovery Plan		
	State	List Date	Federal		List Date	Date	Version	Date
Blue whale (<i>Balaenoptera musculus</i>)			FE	6-2-70				
Finback whale ⁴⁰ (<i>Balaenoptera physalus</i>)			FE	6-2-70				
Humpback whale ⁴¹ (<i>Megaptera novaeangliae</i>)			FE	6-2-70				
Right whale ⁴² (<i>Balaena glacialis</i> (includes <i>australis</i>))			FE	6-2-70				
Sperm whale (<i>Physeter macrocephalus</i> (= <i>catodon</i>))			FE	6-2-70				
California (=Sierra Nevada) bighorn sheep (<i>Ovis canadensis californiana</i>)	SE	8-27-99	FE	1-3-00				
Penninsular bighorn sheep DPS ⁴³ (<i>Ovis canadensis nelsoni</i>)	ST	6-27-71	FE	3-18-98	F	3-5-01	F	2000

⁴⁰ Also known as Fin whale

⁴¹ Also known as Hump-backed whale

⁴² Also known as Black right whale

⁴³ The subspecies *O.c. cremnobates* has been synonymized with *O.c. nelsoni*. Penninsular bighorn sheep are now considered to be a Distinct Vertebrate Population Segment.

**CALIFORNIA SALMONID STREAM
HABITAT RESTORATION MANUAL**

PARTIAL LIST OF STATE AND FEDERALLY LISTED PLANTS

Common Name	Scientific Name	Classification
Ramshaw Meadows Abronia	<i>Abronia alpina</i>	FC
Sonoma Alopecurus	<i>Alopecurus aequalis</i>	FE
Marsh Sandwort	<i>Arenaria paludicola</i>	SE, FE
Fish Slough Milk-Vetch	<i>Astragalus lentiginosus</i> var. <i>piscinensis</i>	FT
Sodaville Milk-Vetch	<i>Astragalus lentiginosus</i> var. <i>sesquimetralis</i>	SE
Bakersfield Smallscale	<i>Atriplex tularensis</i>	SE
Bensoniella	<i>Bensoniella oregona</i>	SR
Nevin's Barberry	<i>Berberis nevinii</i>	SE, FE
Indian Valley Brodiaea	<i>Brodiaea coronaria</i> ssp. <i>rosea</i>	SE
White Sedge	<i>Carex albida</i>	SE, FE
Ash-Gray Indian Paintbrush	<i>Castilleja cinerea</i>	FT
Pitkin Marsh Indian Paintbrush	<i>Castilleja uligosa</i>	SE
Scott's Valley Spineflower	<i>Chorizanthe robusta</i> var. <i>hartwegii</i>	FE
Fountain Thistle	<i>Cirsium fontinale</i> var. <i>fontinale</i>	SE, FE
Chorro Creek Bog Thistle	<i>Cirsium fontinale</i> var. <i>obispoense</i>	SE, FE
Palmate-Bracted Bird's-Beak	<i>Cordylanthus palmatus</i>	SE, FE
Cuyamaca Larkspur	<i>Delphinium hesperium</i> ssp. <i>cuyamaca</i>	SR
Geysers Dichanthelium	<i>Dichanthelium lanuginosum</i>	SE
Cuyamaca Lake Downingia	<i>Downingia concolor</i> var. <i>brevior</i>	SE
Delta Button-Celery	<i>Eryngium racemosum</i>	SE
Boggs Lake Hedge-Hyssop	<i>Gratiola heterosepala</i>	SE
Ash Meadows Gumplant	<i>Grindelia fraxino-pratensis</i>	FT
Water Howellia	<i>Howellia aquatilis</i>	FT
Burke's Goldfields	<i>Lasthenia burkei</i>	SE, FE
Mason's Lilaeopsis	<i>Lilaeopsis masonii</i>	SR
Western Lily	<i>Lilium occidentale</i>	SE, FE
Pitkin Marsh Lily	<i>Lilium pardalinum</i> ssp. <i>pitkinense</i>	SE, FE
Baker's Meadowfoam	<i>Limnanthes bakeri</i>	SR
Point Reyes Meadowfoam	<i>Limnanthes douglasii</i> ssp. <i>sulphurea</i>	SE
Parish's Meadowfoam	<i>Limnanthes gracilis</i> ssp. <i>parishii</i>	SE
Sebastopol Meadowfoam	<i>Limnanthes vinculans</i>	SE, FE
Father Crowley's Lupine	<i>Lupinus padre-crowleyi</i>	SR
Willow Monardella	<i>Monardella linoides</i> ssp. <i>viminea</i>	SE, FE
Amargosa Nitrophila	<i>Nitrophila mohavensis</i>	SE, FE
Calistoga Popcorn-Flower	<i>Plagiobothrys strictus</i>	ST, FE
North Coast Semaphore Grass	<i>Pleuropogon hooverianus</i>	SC
San Bernardino Blue Grass	<i>Poa atropurpurea</i>	FE
Napa Blue Grass	<i>Poa napensis</i>	SE, FE
Santa Lucia Mint	<i>Pogogyne clareana</i>	SE
Hickman's Cinquefoil	<i>Potentilla Hickmanii</i>	SE, FE
Gambel's Water Cress	<i>Rorippa gambelii</i>	ST, FE
Tahoe Yellow Cress	<i>Rorippa subumbellata</i>	SE, FC
Adobe Sanicle	<i>Sanicula maritima</i>	SR
Owens Valley Checkerbloom	<i>Sidalcea covillei</i>	SE
Kenwood Marsh Checkerbloom	<i>Sidalcea oregana</i> ssp. <i>valida</i>	SE FE,
Bird-Foot Checkerbloom	<i>Sidalcea pedata</i>	SE, FE

**CALIFORNIA SALMONID STREAM
HABITAT RESTORATION MANUAL**

Scadden Flat Checkerbloom	<i>Sidalcea stipularis</i>	SE
California Seablite	<i>Suaeda californica</i>	FE
California Dandelion	<i>Taraxacum californicum</i>	FE
Slender-Petaled Thelypodium	<i>Thelypodium stenopetalum</i>	SE, FE
Pacific Grove Clover	<i>Trifolium polydon</i>	SR

The above list of plants includes only those species in the DFG Natural Diversity Data Base in categories relating to selected aquatic and riparian habitats⁴⁴. The statewide species list for state and federal listed plants, species of special concern and federal category species that could be present in areas in or adjacent to fisheries restoration projects is extensive. Many sensitive plant species or communities that are not considered "aquatic" or "riparian" may occur within or near the riparian zones in some watersheds, and upslope control of sediment sources may involve non-riparian habitats. Occurrence of sensitive plant species within a proposed project site should be investigated on a case-by-case basis by personnel trained in botanical surveys, who have knowledge of local plant species. It is recommended that DFG regional plant ecologists be contacted in initial project planning stages for information about the potential of sensitive plant occurrence in or near the project area. In addition, it is recommended that project planners consult the California Native Plant Society's *Inventory of Rare and Endangered Vascular Plants of California*, and the most current version of DFG's *Special Plants List* for specific species status.

Information regarding life history, habits, and distribution for threatened and endangered plant and animal species is provided in *The Annual Report on the Status of California State listed Threatened and Endangered Animals and Plants*, published by DFG; this report is available online at <http://www.dfg.ca.gov>.

⁴⁴ The plant list was compiled for the following CNDDDB Habitats:

- Aquatic
- Bog and Fen
- Freshwater Marsh
- Klamath/N. Coast Flowing Water
- Meadow and Seep
- Riparian Forest
- Riparian Woodland
- South Coast Flowing Water
- Sac. San Joaquin Flowing Water

CALIFORNIA SALMONID STREAM HABITAT RESTORATION MANUAL

Chinook Federal Listing Status Map for California by Evolutionary Significant Unit (ESU).

Please note that the Sacramento Winter ESU (Federal Status: Endangered)
also includes the Central Valley Spring ESU, which has a different Federal listing status (Threatened).

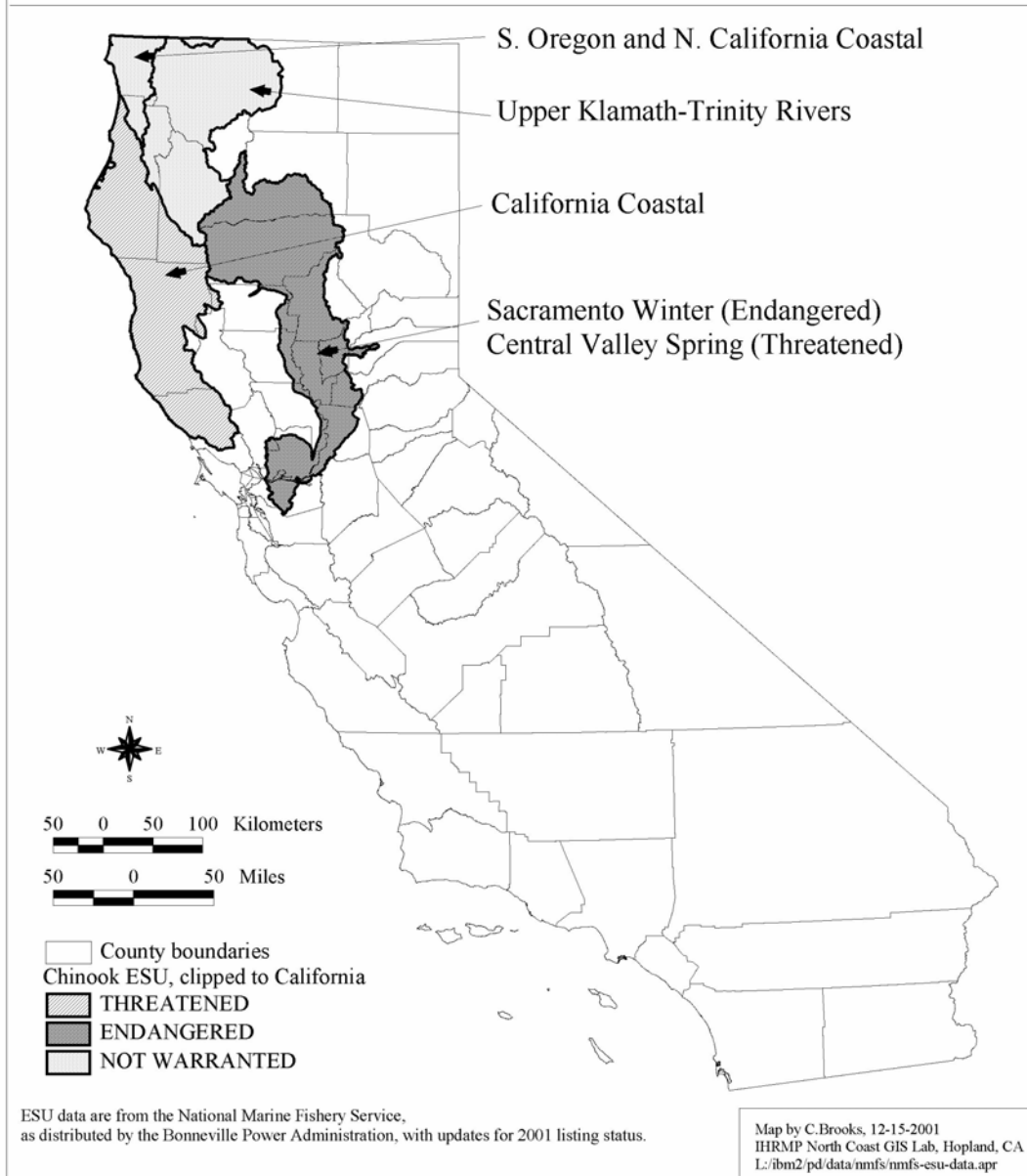

CALIFORNIA SALMONID STREAM HABITAT RESTORATION MANUAL

Steelhead Federal Listing Status Map for California
by Evolutionary Significant Unit (ESU).

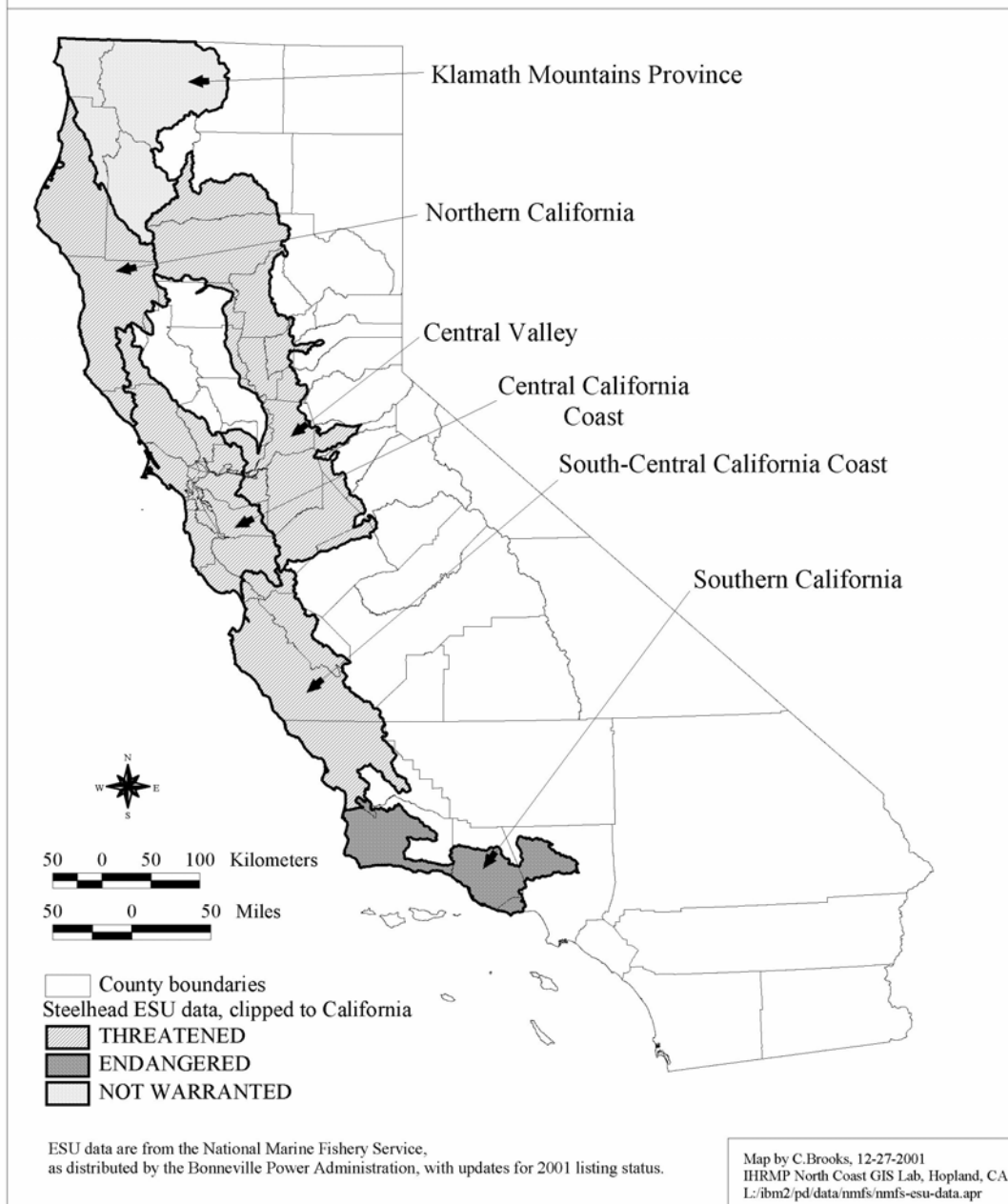

CALIFORNIA SALMONID STREAM HABITAT RESTORATION MANUAL

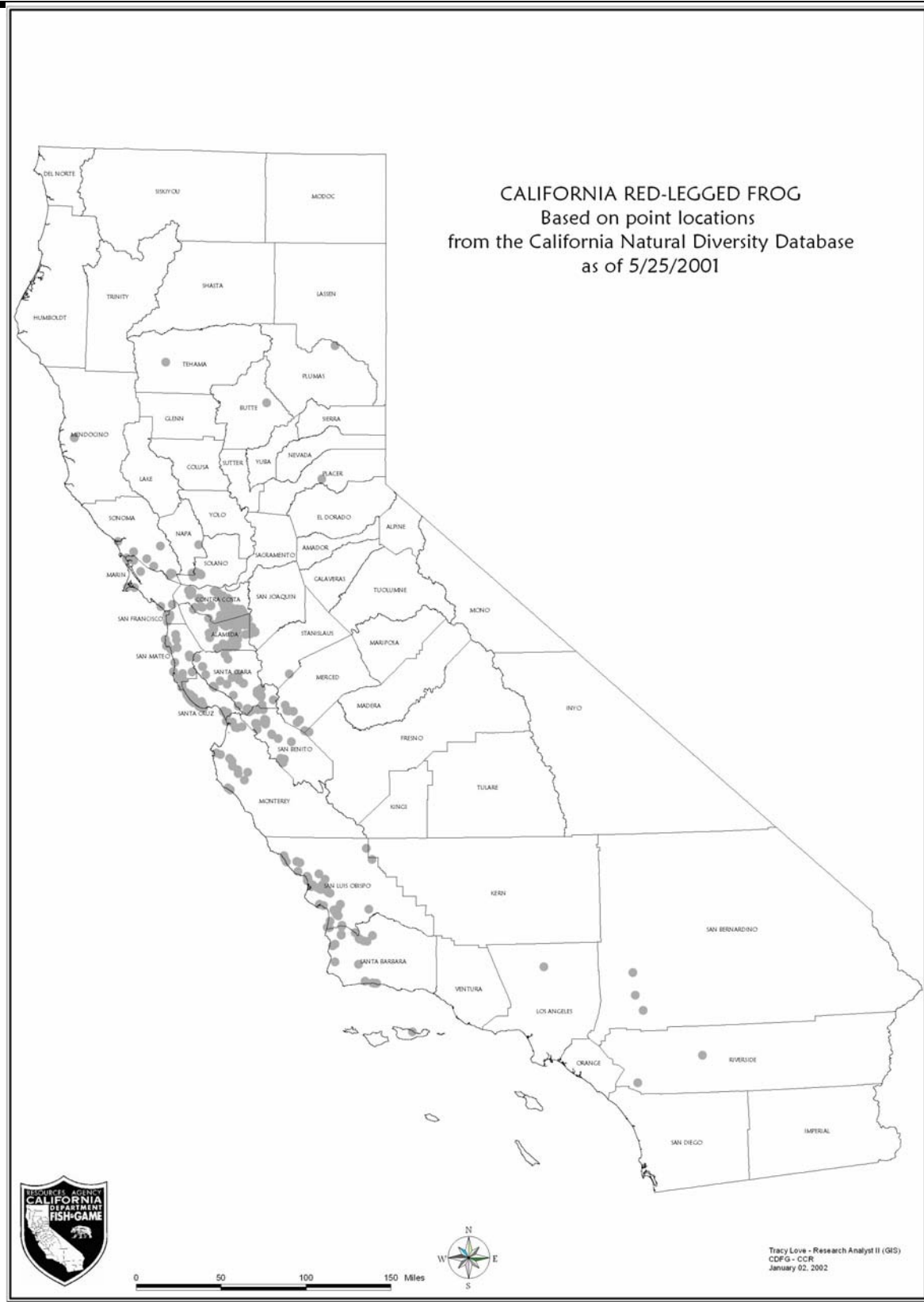

CALIFORNIA SALMONID STREAM HABITAT RESTORATION MANUAL

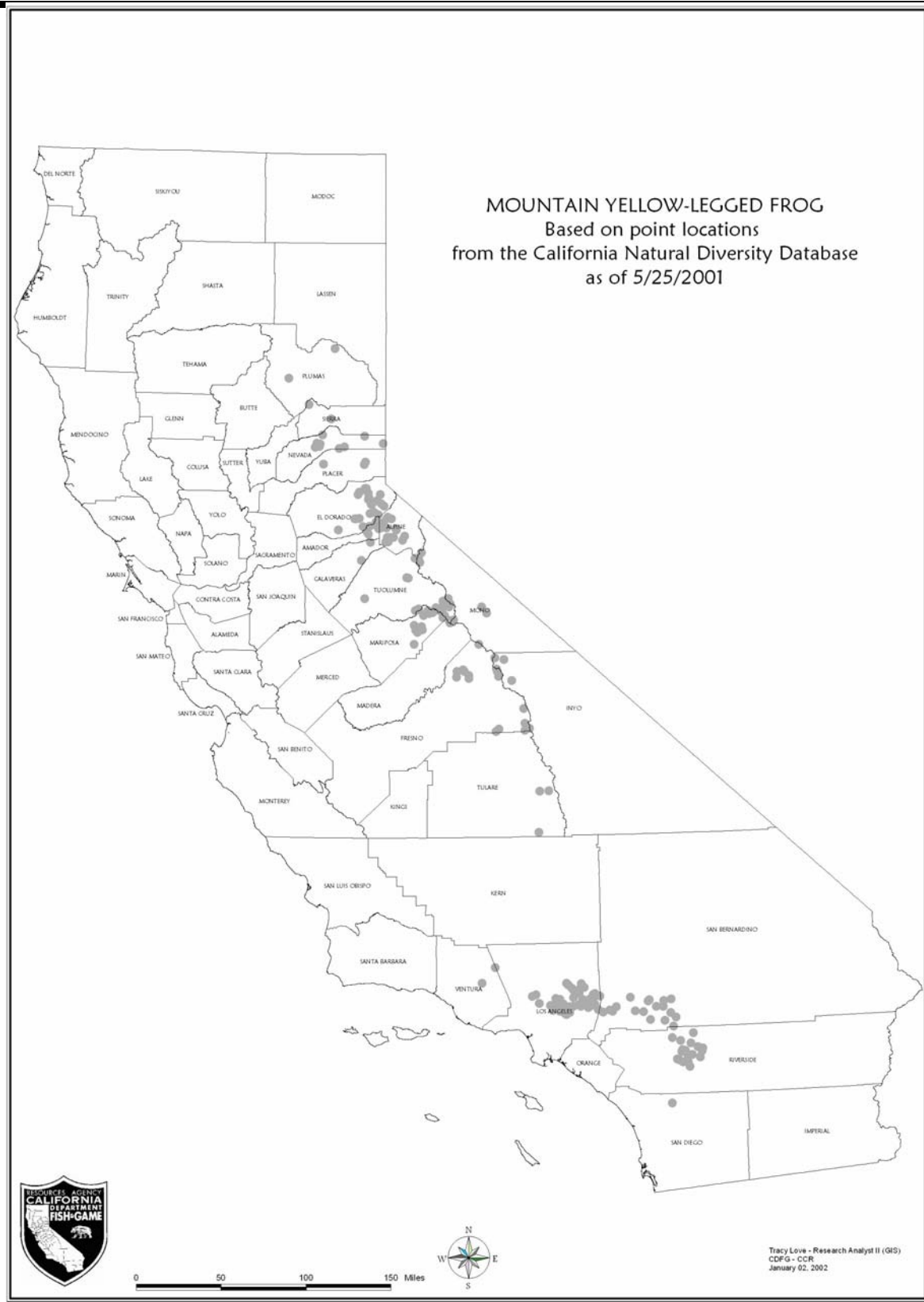

CALIFORNIA SALMONID STREAM HABITAT RESTORATION MANUAL

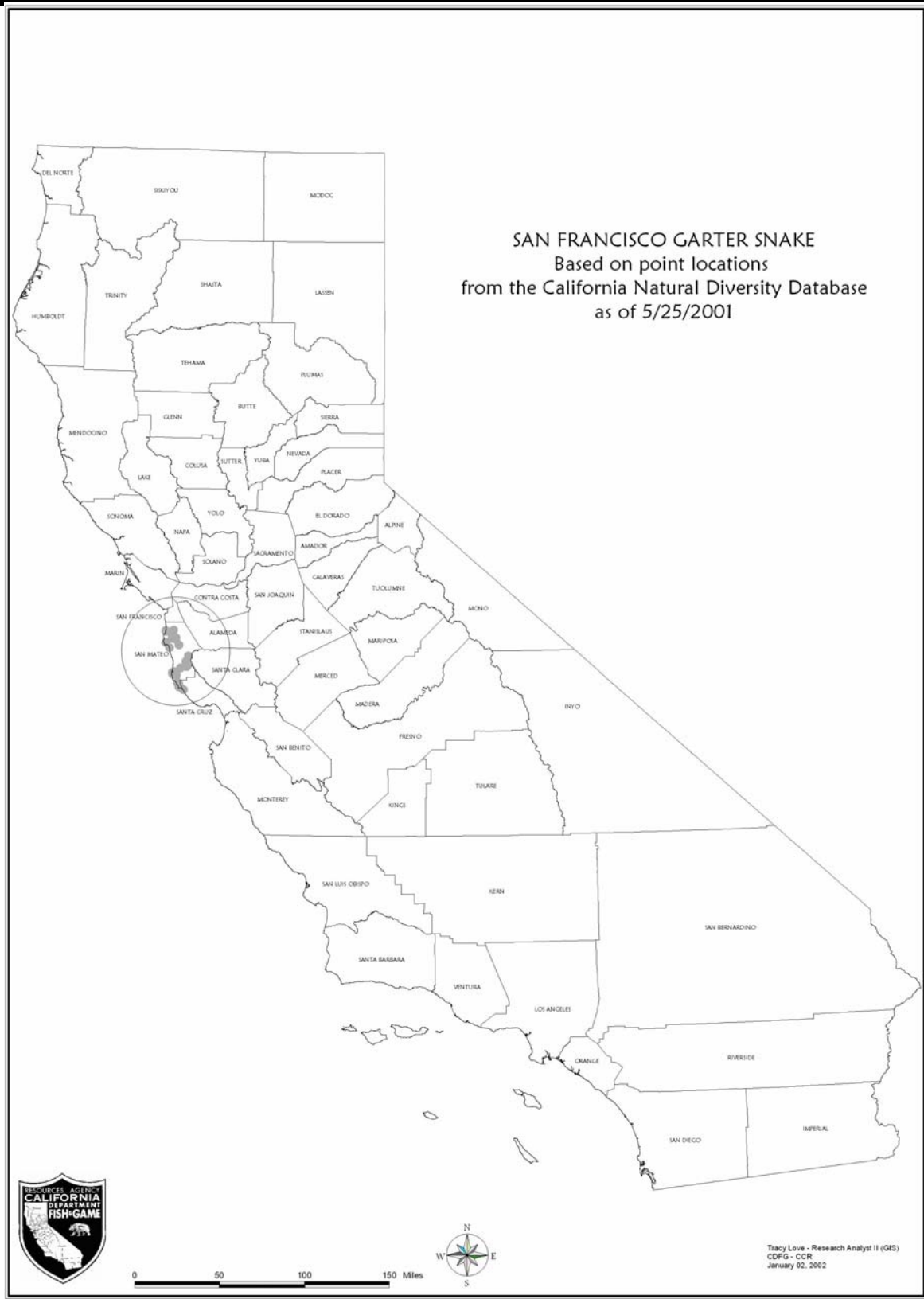

CALIFORNIA SALMONID STREAM HABITAT RESTORATION MANUAL

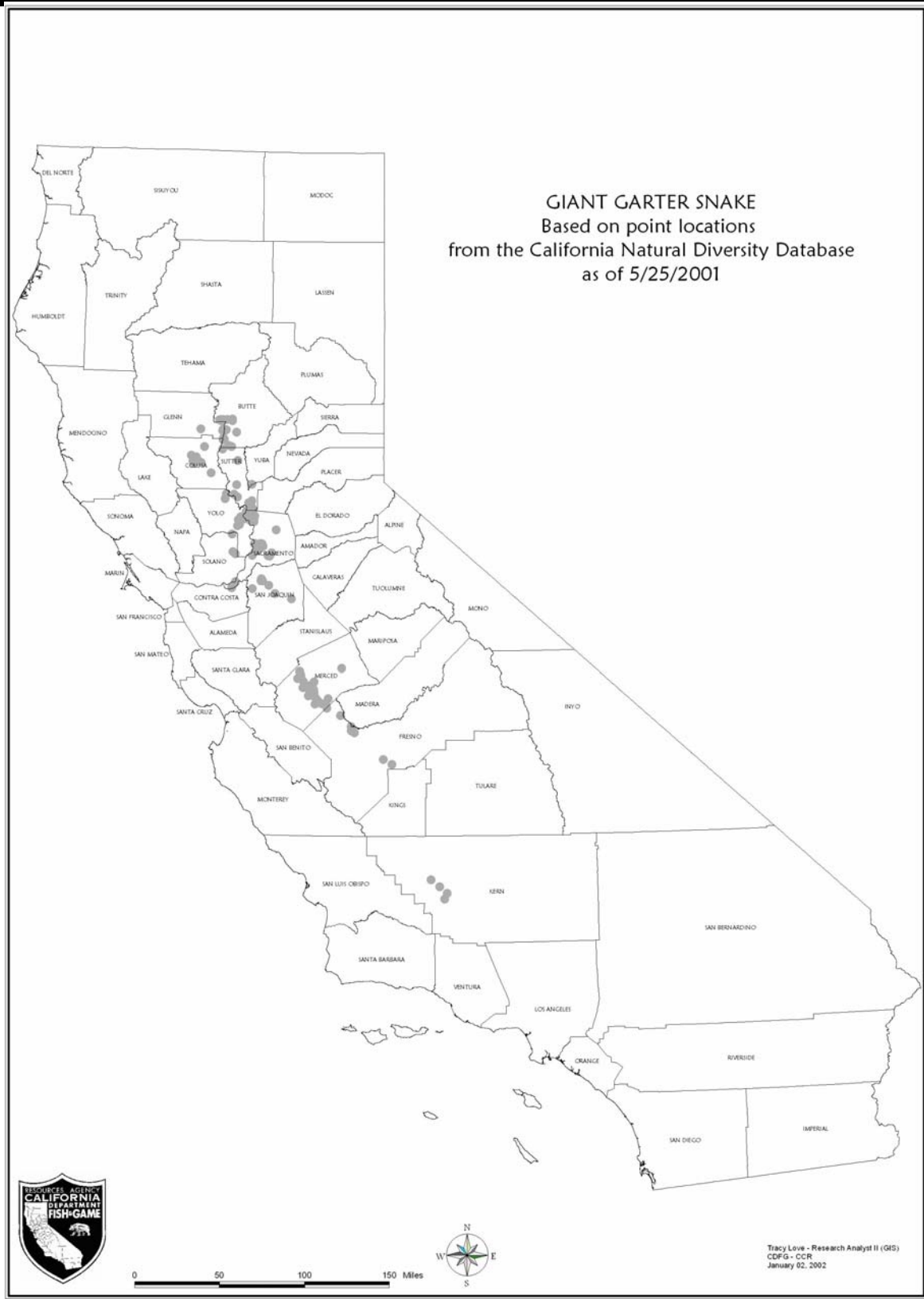

CALIFORNIA SALMONID STREAM HABITAT RESTORATION MANUAL

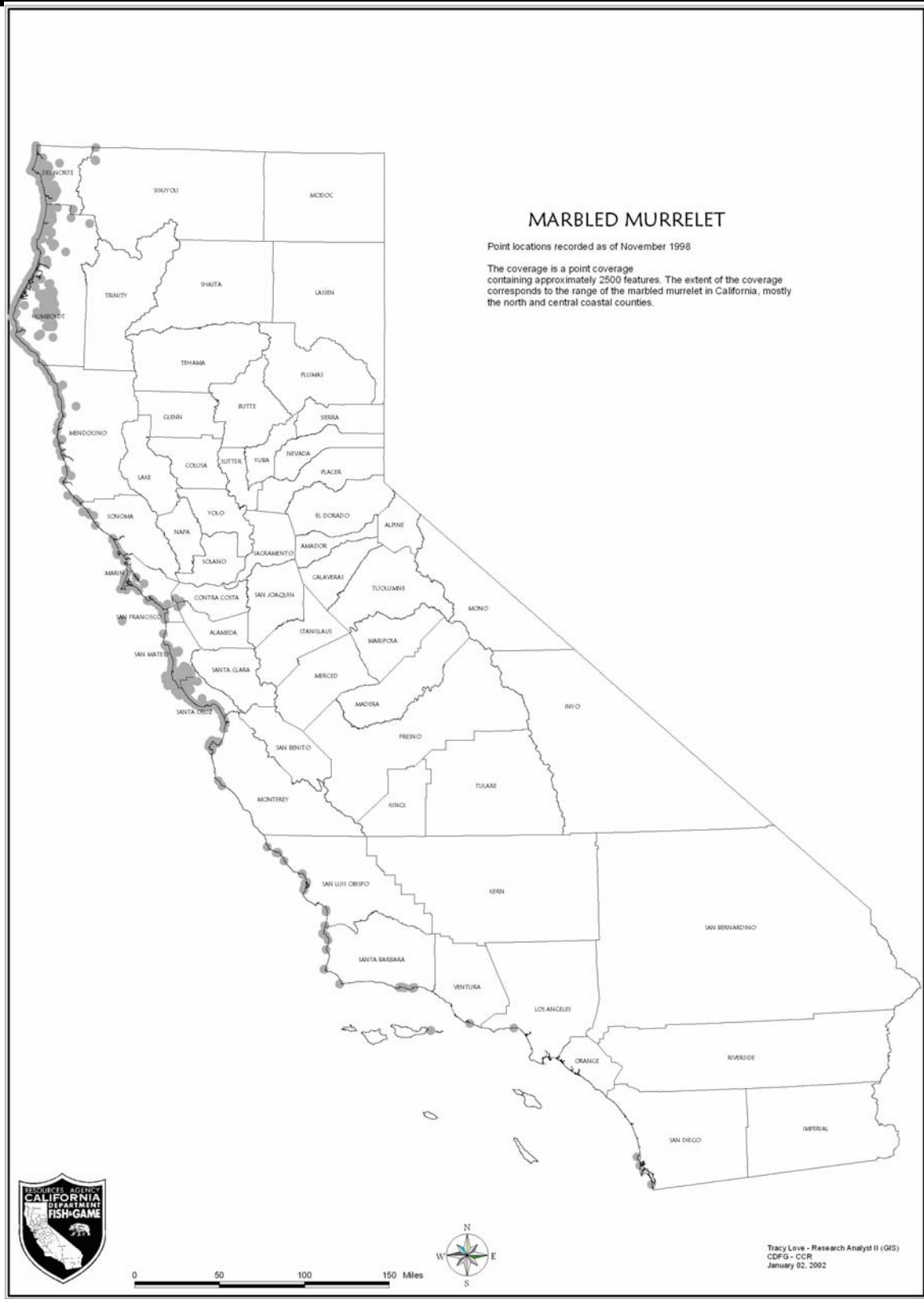

CALIFORNIA SALMONID STREAM HABITAT RESTORATION MANUAL

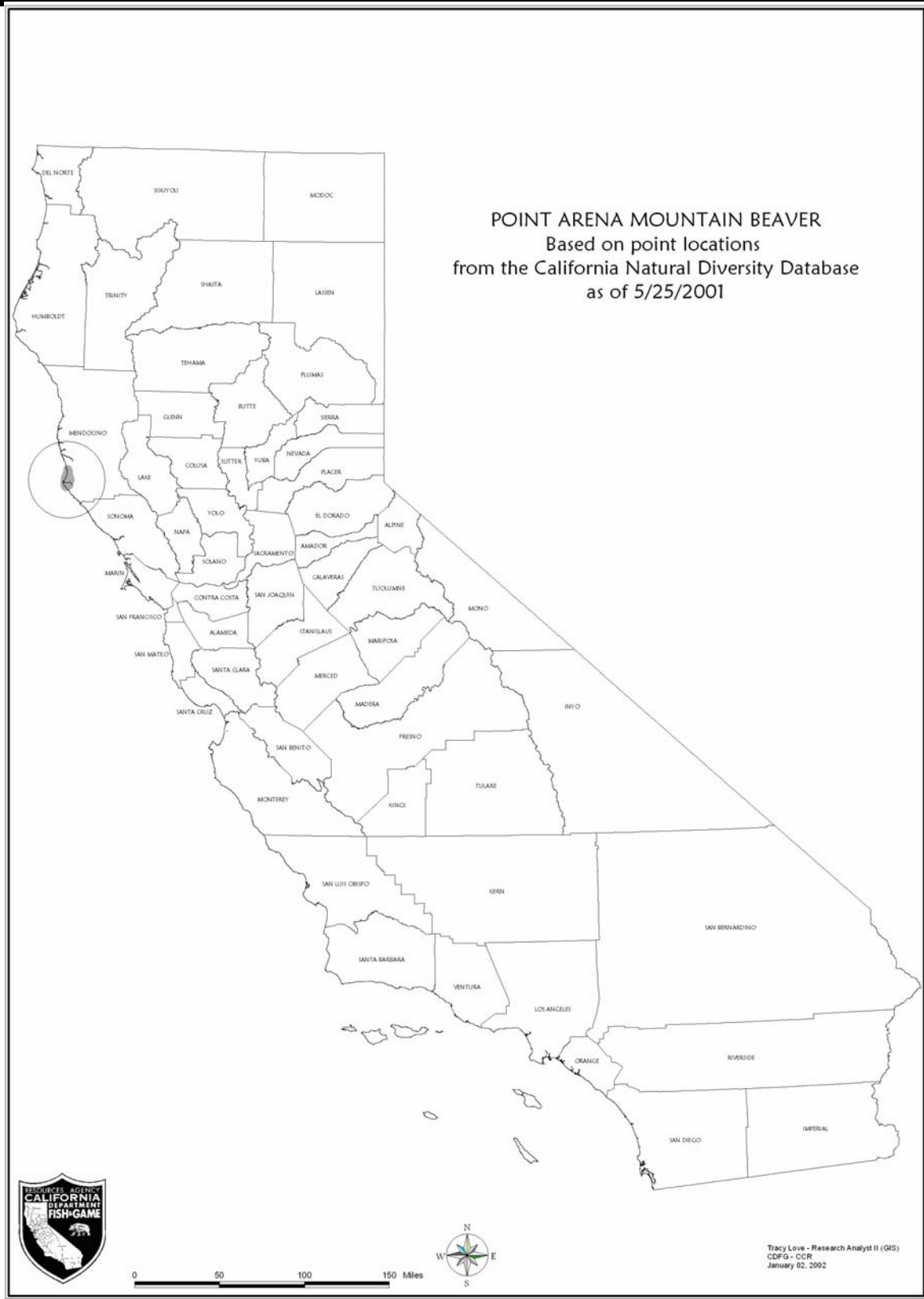

**CALIFORNIA SALMONID STREAM
HABITAT RESTORATION MANUAL**

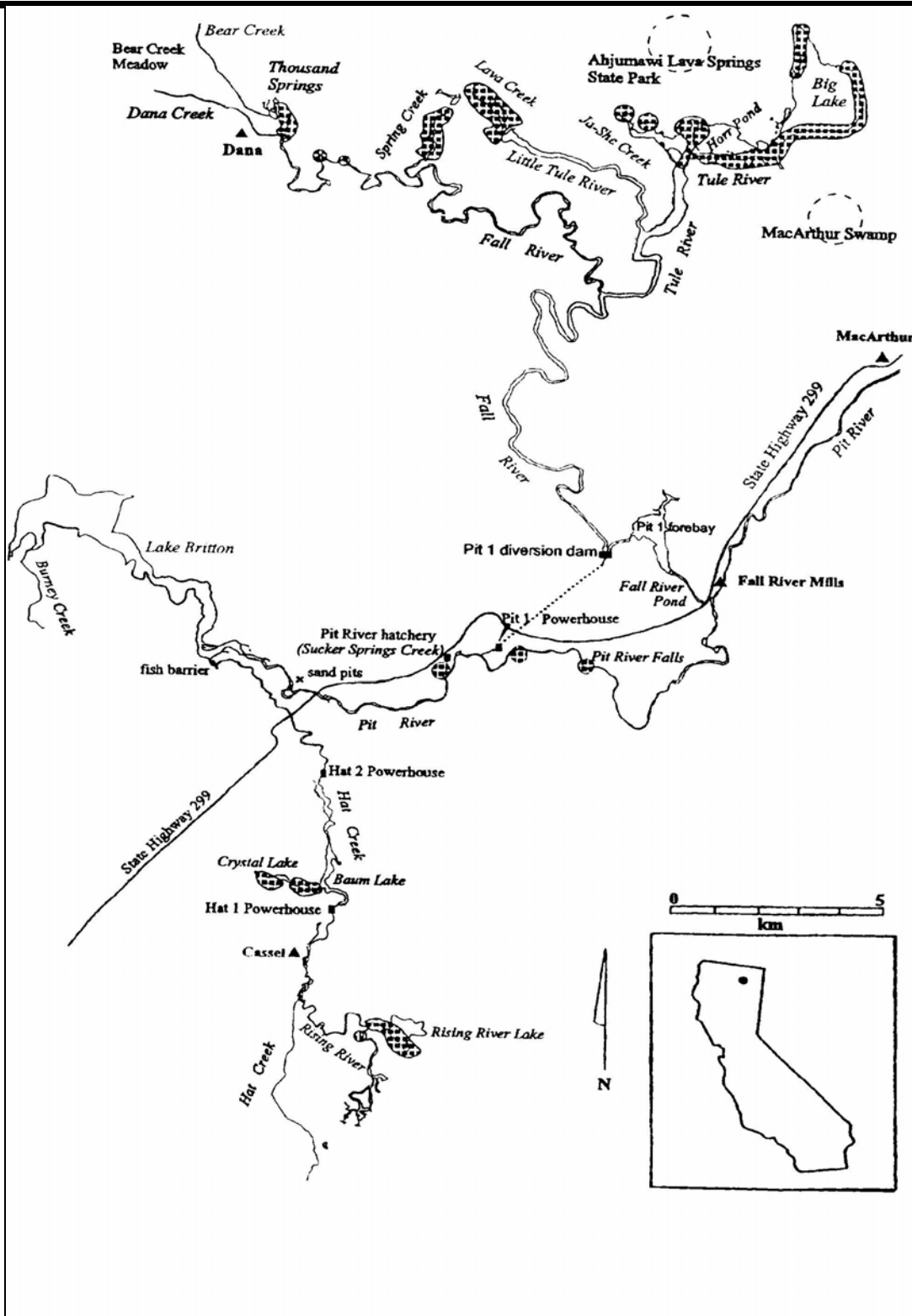

Distribution of all known locations of Shasta crayfish in Shasta County (Source: U.S. Fish and Wildlife Service, Recovery Plan for the Shasta Crayfish (*Pacifastacus fortis*), August 28, 1998).

**CALIFORNIA SALMONID STREAM
HABITAT RESTORATION MANUAL**

APPENDIX G.

CONVERSIONS, MEASUREMENTS, AND ABBREVIATIONS

Length

<u>To convert</u>	<u>Multiply by</u>
Centimeters to inches	0.3937
to feet	0.03281
Feet to meters	0.304801
to centimeters	30.4801
Inches to meters	0.0254
to centimeters	2.54
to millimeters	25.4
Kilometers to miles	0.6214
to feet	3,280.83
Meters to yards	1.0936
to feet	3.2808
to inches	39.37
Miles to kilometers	1.6094
to meters	1,609.35
Millimeters to inches	0.03937
Yards to centimeters	91.4402
to meters	0.9144

Area

<u>To convert</u>	<u>Multiply by</u>
Acres to hectares	0.405
to square feet	43,560.00
to square kilometers	0.004047
to square meters	4,047.00
to square miles	0.00156
Hectares to acres	2.469
to square feet	107,639.1
to square kilometers	0.01
to square meters	10,000.00
to square miles	0.003858
Square centimeters to square inches	0.155

**CALIFORNIA SALMONID STREAM
HABITAT RESTORATION MANUAL**

Area (cont'd)

<u>To convert</u>	<u>Multiply by</u>
Square feet to acres	0.0000229
to hectares	0.0000093
to square centimeters	929.034
to square meters	0.0929
Square inches to square millimeters	645.16
to square centimeters	6.4516
to square meters	0.000645
Square kilometers to acres	247.104
to square miles	0.3861
Square kilometers to hectares	100.00
Square meters to acres	0.000247
to hectares	0.0001
to square feet	10.7639
to square inches	1,550.00
to square yards	1.19599
Square miles to acres	640.00
to hectares	259.20
to square kilometers	2.59
Square millimeters to square inches	0.00155
Square yards to square meters	0.83613

Volume

<u>To convert</u>	<u>Multiply by</u>
Acre-feet to cubic feet	43,560.00
to cubic hectometers	0.0012335
to cubic meters	1,233.5
to cubic yards	1,613.3
to gallons	325,850.00
to cubic kilometers	0.0000012335
Cubic centimeters to cubic feet	0.0000353
to cubic inches	0.061023
to milliliters	1.00
Cubic decimeters to cubic feet	0.035314
to liters	1.00

**CALIFORNIA SALMONID STREAM
HABITAT RESTORATION MANUAL**

Volume (cont'd)

<u>To convert</u>	<u>Multiply by</u>
Cubic feet to acre-feet	0.0000229
to cubic centimeters	28,317.00
to cubic decimeters	28.317
to cubic inches	1,728.00
to cubic meters	0.02832
to cubic yards	0.03704
to gallons	7.48
to liters	28.317
to quarts	29.922
Cubic inches to cubic centimeters	16.387
to cubic feet	0.00058
to fluid ounces	0.554
to gallons	0.0043
to liters	0.0164
to pints	0.0346
to quarts	0.0173
Cubic hectometers to acre-feet	810.70
Cubic meters to acre-feet	0.0008107
to cubic feet	35.314
to cubic yards	1.30794
to gallons	264.170
to liters	1,000.00
Cubic yards to acre-feet	0.0006198
to cubic feet	27.00
to cubic meters	0.7646
Cubic yards to gallons	201.974
to liters	764.559
Gallons to acre-feet	0.00000307
to cubic feet	0.1337
to cubic inches	231.00
to cubic meters	0.003785
to cubic yards	0.00495
to fluid ounces	128.00
to liters	3.78543
Liters to cubic decimeters	1.00
to cubic feet	0.035314
to cubic inches	61.0234
to cubic meters	0.001

**CALIFORNIA SALMONID STREAM
HABITAT RESTORATION MANUAL**

Volume (cont'd)

<u>To convert</u>	<u>Multiply by</u>
Liters to cubic yards	0.0013079
to gallons	0.26417
to pints	2.11336
to quarts	1.05668
Milliliters to cubic centimeters	1.00
Ounces (fluid) to cubic centimeters	29.5737
to cubic inches	1.8047
Pints to cubic inches	28.875
to liters	0.4732
Quarts to cubic feet	0.03342
to cubic inches	57.75
to liters	0.94636

Weight

<u>To convert</u>	<u>Multiply by</u>
Grams to kilograms	0.001
to pounds	0.002205
to ounces	0.03527
Kilograms to grams	1,000.00
to pounds	2.205
to tons (metric)	0.001
to tons (short)	0.0011025
Ounces to grams	28.349527
to pounds	0.0625
Pounds to grams	453.5924
to kilograms	0.45359
to ounces	16.00
to tons (metric)	0.0004536
to tons (short)	0.0005
Tons (metric) to kilograms	1,000.00
to pounds	2,205.00
to tons (short)	1.1025
Tons (short) to kilograms	907.18
to pounds	2,000.00
to tons (metric)	0.90718

**CALIFORNIA SALMONID STREAM
HABITAT RESTORATION MANUAL**

Volume/Time (Flow)

<u>To convert</u>	<u>Multiply by</u>
Acre-feet per day to cubic feet per second	0.5043
to cubic meters per second	0.0143
to gallons per minute	226.24
to million gallons per day	0.3258
Cubic feet/second to acre-feet/day	1.983
to acre-inch per hour	0.992
to cubic feet per day	86,400.00
to cubic meters per second	0.028317
to gallons per day	646,272.00
to gallons per minute	448.80
to gallons per second	7.48
to liters per second	28.317
Cubic meters/second to acre-feet/day	70.0456
to cubic feet per second	35.314
to gallons per minute	15,850.37
to liters per second	1,000.00
to million gallons per day	22.824
Gallons per minute to acre-feet per day	0.00442
to cubic feet per second	0.00223
to cubic meters per second	0.00006309
to gallons per day	1,440.00
to liters per second	0.06309
Liters/second to cubic feet/second	0.035314
to cubic meters per second	0.001
to gallons per minute	15.85
Million gallons/day to acre-feet/day	3.0689
to cubic feet per second	1.547
to cubic meters per second	0.043813
to gallons per minute	695.00

Yield

<u>To convert</u>	<u>Multiply by</u>
Kilograms per hectare to pounds per acre	0.8916
Pounds per acre to kilograms per hectare	1.122

CALIFORNIA SALMONID STREAM HABITAT RESTORATION MANUAL

Temperature

°C is equal to $(^{\circ}\text{F} - 32) \times 5 / 9$

°F is equal to $(^{\circ}\text{C} \times 1.8) + 32$

Miscellaneous Water Measurements

1 gallon of water weighs 8.34 pounds

1 cubic foot of water weighs 62.4 pounds

Acre-feet $\times 43560 / 86400 \times X =$ cubic feet/second discharge
over a period of X days

ABBREVIATIONS

Spell out

acres(s)	mile(s)	ton(s)
cent(s)	month(s)	
dollar(s)	ohm(s)	

Abbreviate

alternating current	ac
barrel(s)	bl
body weight	body wt
bushel(s)	bu
centimeter(s)	cm
count per minute	count/min
count per second	count/s
cubic centimeter(s)	cm ³
cubic foot (feet)	ft ³
cubic foot per second	cfs
cubic kilometer(s)	km ³
cubic meter(s)	m ³
cubic meter per second	m ³ /s
cubic microns(s)	μ ³
cubic millimeter(s)	mm ³
cubic yards(s)	yd ³

CALIFORNIA SALMONID STREAM HABITAT RESTORATION MANUAL

ABBREVIATIONS (cont'd)

Abbreviate

Day	d
degree (space)	deg or °
degree, Celsius	°C
degree, Fahrenheit	°F
diameter	diam
direct current	dc
dozen	doz
dry weight	dry wt
east	E
fathom	fm
focal length	f/
foot (feet)	ft
gallon(s)	gal
grain(s)	gr
gram(s)	g
hectare	ha
horsepower	hp
hour(s)	h
hundredweight	cwt
inch	in.
kilogram(s)	kg
kilometer(s)	km
kilometer per hour	km/h
latitude	lat
lethal concentration, 50%	LC50
lethal dose, medial	LD50
liter	l
logarithm (common, base 10) <u>in formulas</u>	log, log ₁₀
logarithm (natural, base e) <u>in formulas</u>	ln, log _e
longitude	long
meter(s)	m
megagram(s)	Mg
microgram	µg
micron(s) (10 ⁻³ mm)	µ
mile per hour	mile/h
milligram(s)	mg
milligram(s) per gram	mg/g
milligram(s) per liter	mg/l
milliliter(s)	ml

CALIFORNIA SALMONID STREAM HABITAT RESTORATION MANUAL

ABBREVIATIONS (cont'd)

Abbreviate

millimeter(s)	mm
minimum or minute(s)	min
minute (time)	min
north	N
number (in enumeration)	no.
ounce	oz
page(s)	p.
parts per billion	ppb
parts per million	ppm
percent	%
per thousand	o/oo
pound(s)	lb
pounds per square inch	lb/in ²
second(s) (time)	s
second(s) (angular measure)	"
south	S
species (taxonomy only, singular)	<u>sp.</u>
species (taxonomy only, plural)	<u>spp.</u>
species, new	<u>sp. nov.</u>
specific gravity	sp gr
square	sq
square centimeter(s)	cm ²
square foot (feet)	ft ²
square meter(s)	m ²
square millimeter(s)	mm ²
standard deviation	SD
standard error	SE
subspecies	<u>ssp.</u>
Temperature	temp
Time	use 24-hr system
variety(ies)	var.
volt	v
volume (with number in tables)	V
volume/volume (conc.)	v/v
watt	W
week	wk
weight	wt
west	W

CALIFORNIA SALMONID STREAM HABITAT RESTORATION MANUAL

ABBREVIATIONS (cont'd)

Abbreviate

Yard	yd
Year	yr

Write latitude in the form: lat 33°41'30"N

Write longitude in the form: long 118°09'05"W

CALIFORNIA SALMONID STREAM HABITAT RESTORATION MANUAL

APPENDIX H.

THE MANNING ROUGHNESS COEFFICIENT

Typical channel designs rely on hydraulic engineering criteria and geomorphic parameters, such as critical bed and bank shear stresses, considerations of bedload transport, and "equilibrium" valley slopes (Rundquist et al., 1986; Jackson and Van Haveren, 1984). Other work utilizes empirical equations, that despite their limitations, continue to demonstrate their utility (Dury 1973; Williams 1986). The reader is referred to Graf (1971), U.S. Army Corps of Engineers (1970), and Bray (1982) for a review of common design approaches. For our purposes, we will follow a utilitarian approach, that allows designers to predict if a modified cross-section will convey the bankfull discharge.

Geomorphic research (Wolman and Leopold 1957; Hey 1982) has shown that most rivers experience a bankfull flood once every two years, and that these flows are the most important in defining channel shape (Wolman and Miller 1960; Yu and Wolman, 1987). Although other flows are important, for our purposes, bankfull discharge (Q_{bf}) is designated as the design discharge.

The Manning Equation and Profile Alterations

The Manning equation is a common mathematical method for designing channel modifications (Mott 1979; Dunne and Leopold 1978). One form of the Manning equation is presented here.

$$Q_{bf} = (1.49 R^{2/3} S^{1/2}) / n (A)$$

- Where:
- Q_{bf} = bankfull discharge (ft^3/s)
 - R = hydraulic radius (ft) and $R = WP/A$, (the ratio of wetted perimeter to cross-sectional area of flowing water), where WP = wetted perimeter (ft)
 - A = area of cross-section below the Q_{bf} elevation (ft^2)
 - S = average slope of the longitudinal profile or longitudinal template (ft/ft)
 - n = the dimensionless Manning roughness coefficient

CALIFORNIA SALMONID STREAM HABITAT RESTORATION MANUAL

For the form of the Manning equation described here, discharge (Q_{bf}) can be calculated from a cross-section or preferably, derived from discharge records, slope (average for the reach) is derived from the longitudinal profile data. The Manning roughness coefficient "n" is selected from reference books, or more preferably, back calculated from a specific paired reference cross-section. Hydraulic radius (R) and cross-sectional area (A), both descriptors of cross-sectional configuration, are manipulated using reference templates as a guide, through the introduction of structures or other features to create a suitable geometry for a particular site. It is evident that different channel shapes can have the same hydraulic radius and cross-sectional area, (e.g., a trapezoidal channel versus a semi-circular or triangular channel). Consequently, the real test of this approach is to arrive at an inherently stable channel geometry that also provides quality instream habitat for fish. In this work, there is no better help available than that provided by existing stream features. Since the reference templates serve as examples of existing stream conditions, designers should rely on them as valuable references. Again: Mimic nature.

Because this equation is sensitive to the value of the "n" coefficient, it is easy to under-design or over-design a channel modification. Consequently, references have been developed to assist in assigning an "n" value. These references are based on actual calculations of "n" from known discharge and cross-sectional data (Barnes 1967; Dunne and Leopold 1978; and Jarrett 1985). Because most channels in mountain environments have a high degree of bed armor and channel roughness, "n" values for these channels usually range between 0.05 and 0.08. For specific enhancement cross-sections an "n" value should be back calculated from the matched reference cross-section.

Guidelines for cross-sectional channel shapes are difficult to categorize, because of the range of variation in natural channels. However, a modified trapezoid shape is usually appropriate for riffle and run sections. Pool cross-sections vary with their location in the channel (e.g. bends vs inflections), but most commonly encountered pool cross-sections are asymmetric. In other words, they have shallow slip-off slopes on the inner bank and near steep slopes on the outer bank. Pools also tend to be about 25 percent less wide than riffles. Cross-sectional modifications should mimic these shapes as close as practical. Again, use the matched reference templates as guides for new channel configurations.

Designers only need to fit, through trial and error calculation with the Manning equation, an altered cross-section to the design discharge (Q_{bf}). For example, the first trial cross-section (existing shape with an added structural modification), when solved for its component parts of hydraulic radius (R) and area (A), may produce a configuration which cannot convey the design discharge. With this knowledge, the trial cross-section is modified, using the reference cross section as a guide, but with a larger area, and a greater R value. When this new trial cross-section is broken down into its component parts and inserted into the Manning equation, the design discharge may be slightly higher than necessary. At this point in the iterative process it is often helpful to refer back to the field notes and longitudinal templates to reconfirm or reject earlier assumptions concerning the reference cross-section and the modified cross-section.

CALIFORNIA SALMONID STREAM HABITAT RESTORATION MANUAL

The designer should pay close attention to all the channel forming variables (e.g., a bedrock bank, sudden change in stream direction, instream roughness objects, slope and length of up stream riffle, slope and length of down stream riffle, slope and length of pool feature, etc.) when modifying a cross-section. Designers should attempt to simulate as many of these variables as possible using the reference section, field notes and longitudinal profile templates as guides. If a channel design is too "large" for a given Q_{bf} , the section may have a tendency to fill with sediment. Conversely, if a cross-section is too "small" for a given Q_{bf} , then the section may have a tendency to scour. It is important to persevere, and reach a final configuration that fits the channel forming discharge or Q_{bf} . Eventually, an appropriate altered channel cross-sectional shape is derived along with a set of assumptions that must be met during construction.

Another dimension to this process is to observe changes in discharge capacity by varying "n" values. For example, a channel described as having a cobble bottom and clean sides may have an "n" of 0.040, while the same channel with bank vegetation may have an "n" of 0.055. Because it is better to over-design than under-design a channel modification, "n" should be chosen conservatively. For more accuracy in complex situations, individual cross-sections can be divided into vertical segments, with individual "n" values assigned to each segment. This procedure enables greater precision, particularly for complex asymmetrical cross-sections, and is described in detail by Chow (1959). This design process can be simplified by using computer programs for either programmable calculators or micro-computers. Most computer-based drawing programs easily calculate areas for non-symmetrical polygons and perimeters, facilitating rapid iterations.

Channel Manipulation Through Placement of Instream Structures

Longitudinal and Cross-Sectional Analysis of an Actual Reach.

Longitudinal and cross-sectional data for a tributary of the Klamath River in northern California were selected to provide an example of how a designer might install a wing deflector within a reach to create a pool. To illustrate the design methodology described herein, only one of the final cross-section designs is presented; normally, a complete series of design cross-sections would be compiled. The number of cross-sections needed depends on the complexity of the site and the degree of channel changes required. Usually a minimum of 3 or 4 design cross-sections are required, while lengthy or complex sites may require dozens.

Figure H-1 shows a segment of the longitudinal profile identified as a run with the potential for modification into a pool. Notice that the average slope for the reach is similar for both the reference pool and the design site. Also the slopes of both the up and down stream riffles correspond favorably. The field notes identify, "Station 42+23...what appears to be an overly wide channel at this point allows stream energy to be dissipated over a broad cross-section...". Confining the cross-sectional area through the design site might transform this run into a pool.

CALIFORNIA SALMONID STREAM HABITAT RESTORATION MANUAL

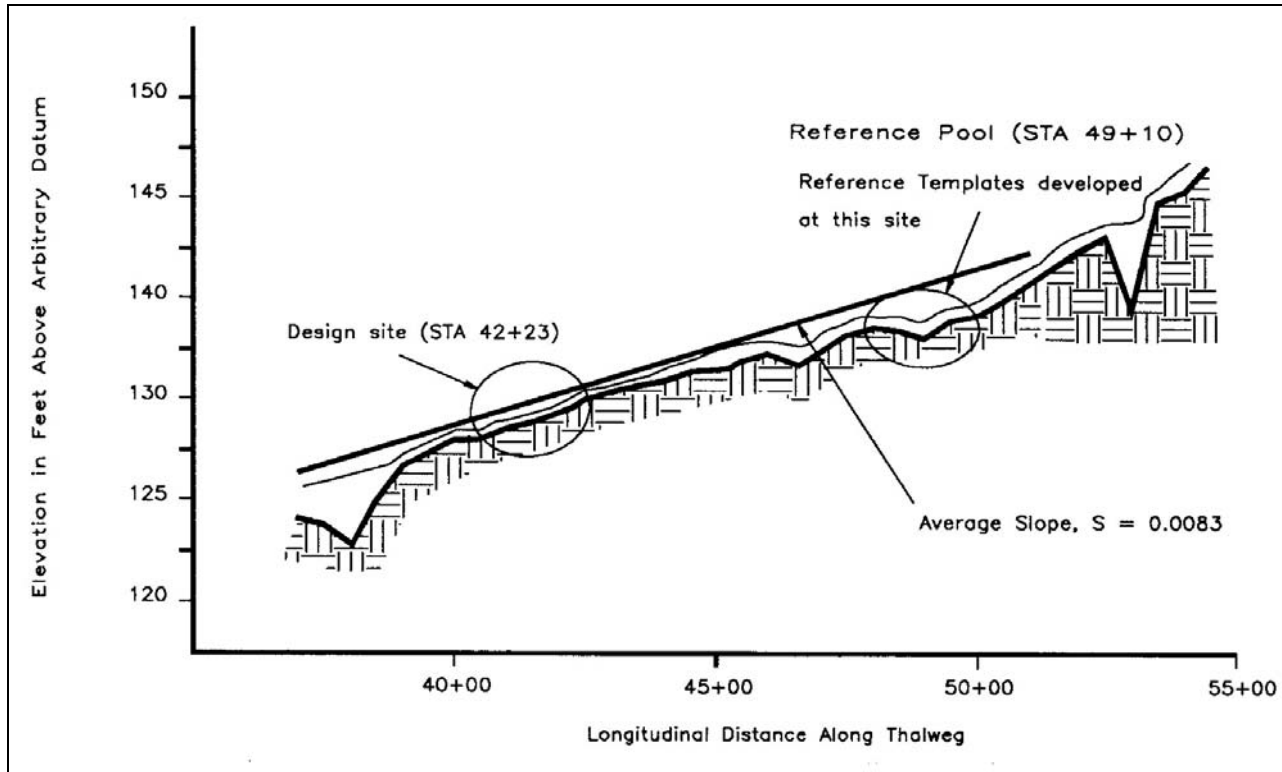

Figure H-1. Longitudinal profile of a design reach, Tarup Creek, Del Norte County, California. (Inter-Fluve, Inc. 1984).

Drafting the cross-sectional survey for the run at Station 42+23 produces the profile in Figure 2. When compared with the selected reference cross section for a pool (Station 49+10), the previously derived conclusions of the field notes can be confirmed; the cross section at STA 42+23 is overly wide and shallow. Since this run is located on a shallow bend to the left, a pool will be designed on the outside of this bend using a log wing deflector to alter the cross section and simulate the shape of the reference section. Note that the reference template matched with the station 42+23 cross section in Figure H-2 has been flipped horizontally to correspond with a left bank pool.

CALIFORNIA SALMONID STREAM HABITAT RESTORATION MANUAL

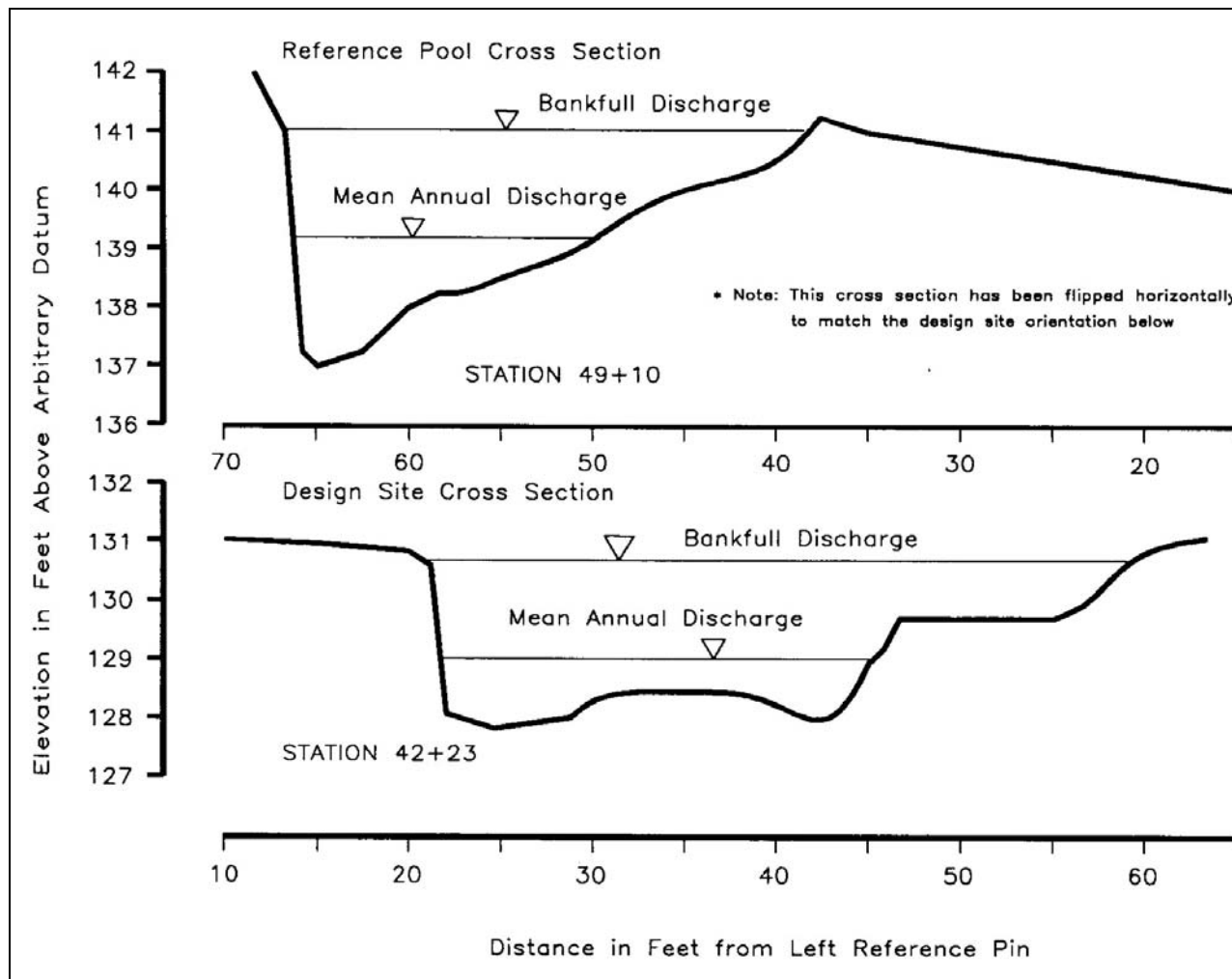

Figure H-2. Cross-sectional profiles of a reference pool and a selected design site, Tarup Creek, Del Norte County, California. (Inter-Fluve, Inc. 1984).

Design of a Habitat Alteration Using the Manning Equation as a Guide.

As previously stated, altered cross-section designs should closely resemble the reference template. The ability to emulate the stability and function of the reference cross section plays a major role in the success of this technique. Remember too, if a channel design is too "large" for a given bankfull discharge (Q_{bf}), the section will have a tendency to fill, and if too "small", the section will have a tendency to scour.

Bankfull discharge elevations for the reference pool and new design criteria are matched by superimposing the reference pool template on the design site template. For clarity, the two templates are shown separately in Figure H-3. Matching bankfull discharge elevations is required to maintain water surface continuity. The "New Design Site Cross Section" replaces the gravel bar of the existing cross section with a log-wing deflector. The new cross section now matches the template. This combination of the reference template, STA 42+23 cross section, and the log-wing deflector becomes the first trial cross section to be subjected to hydraulic analysis.

CALIFORNIA SALMONID STREAM HABITAT RESTORATION MANUAL

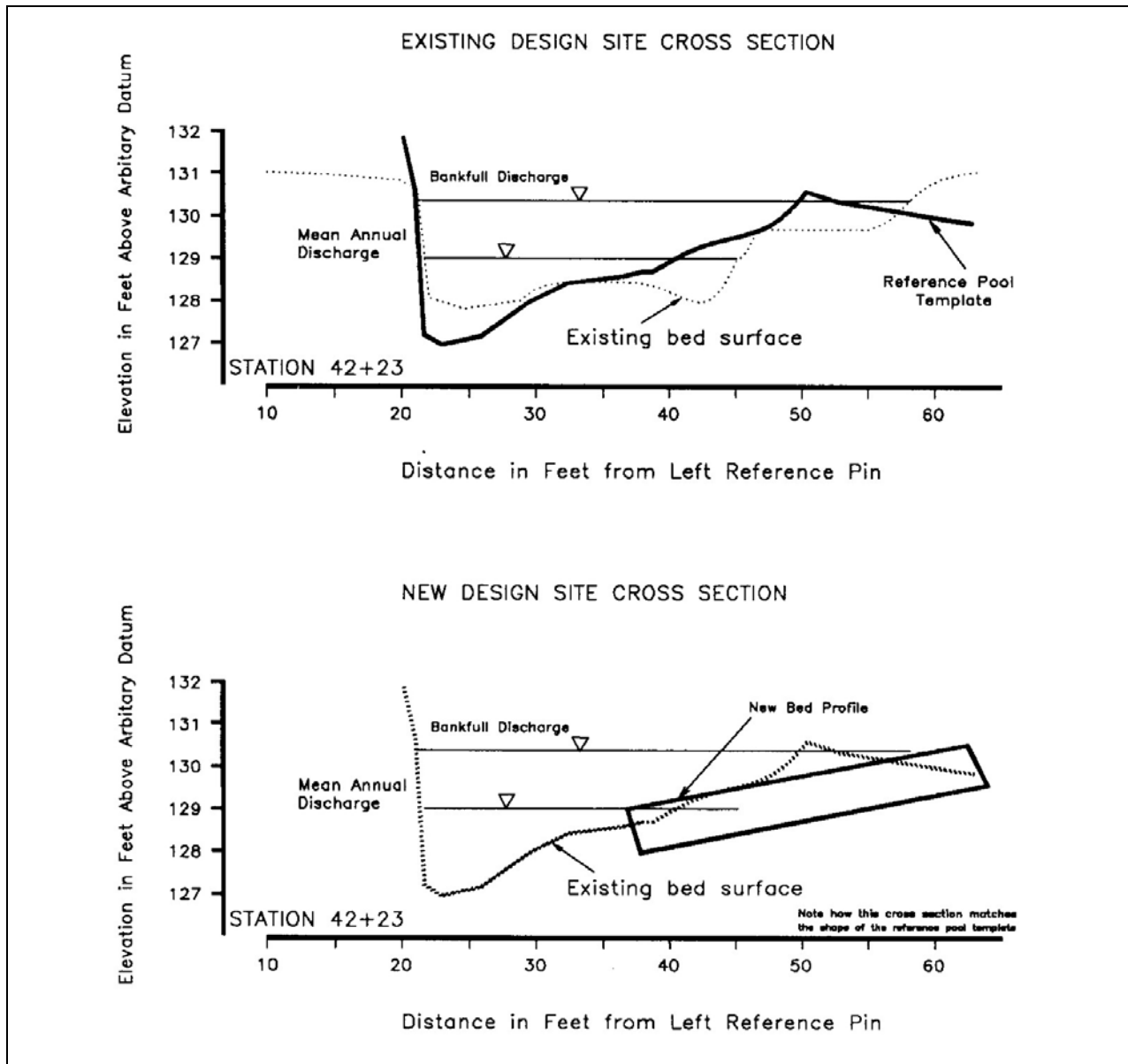

Figure H-3. Cross-sectional profile of a reference pool superimposed on a selected design site, Tarup Creek, Del Norte County, California (Inter-Fluve, Inc. 1984).

Multiple iterations, each time substituting different values for A and R in the Manning equation, results in the final cross section, shown as Figure H-4. Notice that to maintain the same bankfull discharge and provide exemplary pool habitat, cross-sectional area was altered and consequently some bottom material must be removed from the channel to form the pool. Actual construction specifications should depict the placement of this material around the wing deflector, smoothing the log's transition into the existing topography. Further similar hydraulic analysis (not shown in this example) for upstream and downstream stations would produce a series of cross-section designs fully describing the site.

CALIFORNIA SALMONID STREAM HABITAT RESTORATION MANUAL

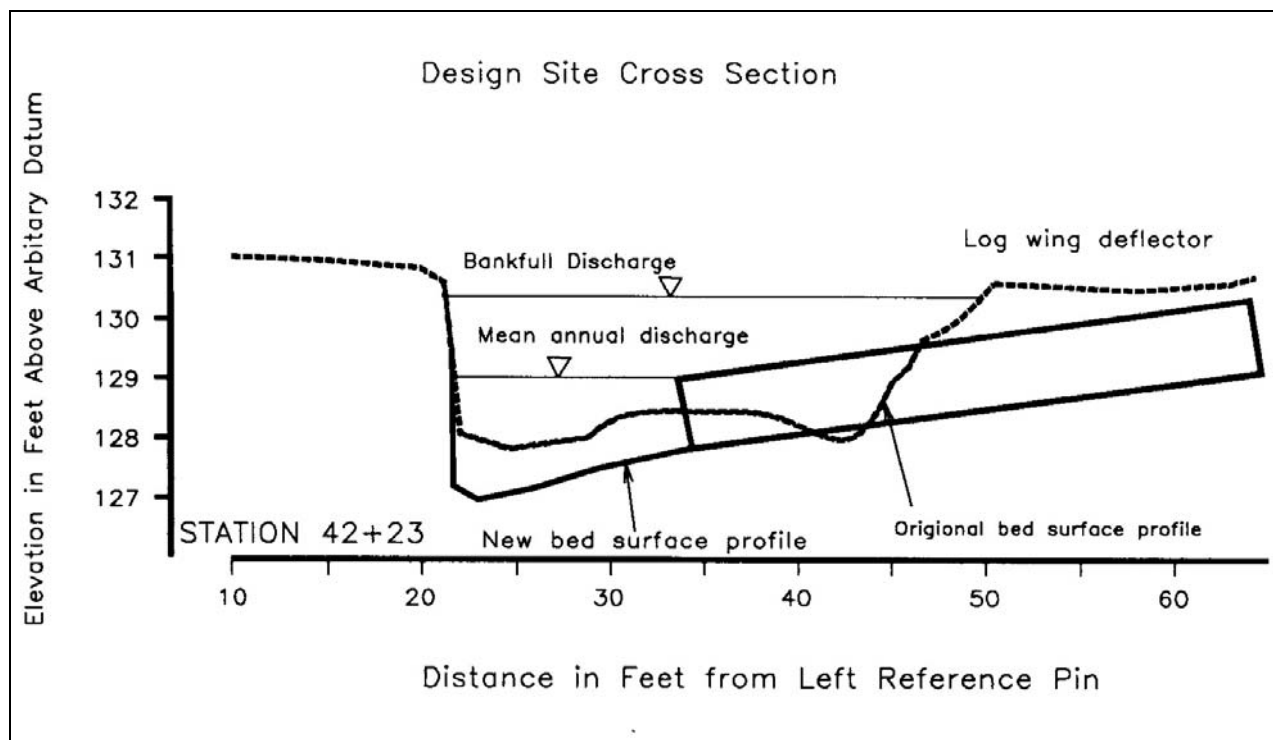

Figure H-4. Final cross-sectional design profile for station 42+23, Tarup Creek, Del Norte County, California. (Inter-Fluve, Inc. 1984).

This hydraulic analysis method enables the designer to estimate the bankfull discharge passed by the enhanced cross-section and clarifies the intensity of work required to modify the stream channel. More importantly, this method allows designers to achieve a major enhancement goal: to faithfully emulate natural cross sections that are providing desirable fish habitats.

Background Theory

Two methods for determining the Manning roughness coefficient or "n" value will be given. The first is from a table of "n" values (Table 1) reproduced with permission from McGraw-Hill, Inc. from the *Handbook of Hydraulics*, Brater, Ernest F. and King, Horace Williams, 1976., Sixth Edition, McGraw-Hill, USA. The second is a method for actually calculating the Manning roughness coefficient "n" based on measurement of flow and channel cross sections by George Heise, Associate Hydraulic Engineer, California Department of Fish and Game. The "n" value from the table will be adequate most of the time. For precise work, the calculated "n" value is recommended.

**CALIFORNIA SALMONID STREAM
HABITAT RESTORATION MANUAL**

Table H-1. Values of "n" to be used with the Manning equation.

Surface	Best	Good	Fair	Bad
Uncoated cast-iron pipe	0.012	0.013	0.014	0.015
Coated cast-iron pipe	0.011	0.012*	0.013	
Commercial wrought-iron pipe, black	0.012	0.013	0.014	0.015
Commercial wrought-iron pipe, galvanized	0.013	0.014	0.015	0.017
Smooth brass and glass pipe	0.009	0.010	0.011	0.013
Smooth lockbar and welded "OD" pipe	0.010	0.011*	0.013*	
Riveted and spiral steel pipe	0.013	0.015*	0.017*	
Vitrified sewer pipe	0.010 or 0.011	0.013*	0.015	0.017
Common clay drainage tile	0.011	0.012*	0.014*	0.017
Glazed brickwork	0.011	0.012	0.013*	0.015
Brick in cement mortar; brick sewers	0.012	0.013	0.015*	0.017
Neat cement surfaces	0.010	0.011	0.012	0.013
Cement mortar surfaces	0.011	0.012	0.013*	0.015
Concrete pipe	0.012	0.013	0.015*	0.016
Wood stave pipe	0.010	0.011	0.012	0.013
Plank Flumes:				
Planed	0.010	0.012*	0.013	0.014
Unplaned	0.011	0.013*	0.014	0.015
With battens	0.012	0.015*	0.016	
Concrete-lined channels	0.012	0.014*	0.016*	0.018
Cement-rubble surface	0.017	0.020	0.025	0.030
Dry-rubble surface	0.025	0.030	0.033	0.035
Dressed-ashlar surface	0.013	0.014	0.015	0.017
Semicircular metal flumes, smooth	0.011	0.012	0.013	0.015
Semicircular metal flumes, corrugated	0.0225	0.025	0.0275	0.030
Canals and Ditches:				
Earth, straight and uniform	0.017	0.020	0.0225*	0.025
Rock cuts, smooth and uniform	0.025	0.030	0.033*	0.035
Rock cuts, jagged and irregular	0.035	0.040	0.045	
Winding sluggish canals	0.0225	0.025*	0.0275	0.030
Dredged earth channels	0.025	0.0275*	0.030	0.033
Canals with rough stony beds, weeds on earth banks	0.025	0.030	0.035*	0.040
Earth bottom, rubble sides	0.028	0.030*	0.033*	0.035

**CALIFORNIA SALMONID STREAM
HABITAT RESTORATION MANUAL**

Table H-1 (cont'd). Values of "n" to be used with the Manning equation.

Surface	Best	Good	Fair	Bad
Natural Stream Channels				
(1) Clean, straight bankfull stage, no rifts or deep pools	0.025	0.0275	0.030	0.033
(2) Same as (1), but some weeds and stones	0.030	0.033	0.035	0.040
(3) Winding, some pools and shoals, clean	0.033	0.035	0.040	0.045
(4) Same as (3), lower stages, more ineffective slope and sections	0.040	0.045	0.050	0.055
(5) Same as (3), some weeds and stones	0.035	0.040	0.045	0.050
(6) Same as (4), stony sections	0.045	0.050	0.055	0.060
(7) Sluggish river reaches, rather weedy or with very deep pools	0.050	0.060	0.070	0.080
(8) Very weedy reaches	0.075	0.100	0.125	0.150

* Values commonly used in designing.

CALIFORNIA SALMONID STREAM HABITAT RESTORATION MANUAL

Calculation of Manning Roughness Coefficient "n" Based on Field Measurements

The following procedure for back calculating Manning roughness coefficients from measured discharge and measured channel cross-sections is based on Geological Survey Water-Supply Paper 1849 *Roughness Characteristics of Natural Channels* (Barnes 1967).

The analysis is limited to turbulent flow in fully rough channels. This condition is usually present in natural channels. It should be noted that channel roughness may vary with depth from the influence of riparian vegetation or other roughness elements in the channel. Where possible, flow measurements should be taken and calculations made at more than one rate of discharge.

Background and Theory

Most open-channel flow formulas can be expressed in the following general terms,

$$Q = C A R^x S^y \quad (1)$$

where: Q is the discharge, in cubic feet per second; C is a factor of flow resistance; A is the wetted cross-sectional area of the channel, in square feet; R is the hydraulic radius, in feet; and S is the energy gradient, in feet/feet. The Manning equation is a well known variation of equation (1) and can be used as the basis for computing reach properties and roughness coefficients. The Manning equation is

$$Q = \frac{1.486}{n} A R^{2/3} S^{1/2} \quad (2)$$

where: n is a roughness coefficient and other variables in the equation are as defined above.

CALIFORNIA SALMONID STREAM HABITAT RESTORATION MANUAL

The Manning equation was developed for conditions of uniform flow in which the water surface profile and energy gradient are parallel to the streambed, and the area, hydraulic radius, and depth remain constant throughout the reach. For lack of a better solution, it is assumed that the equation is also valid for nonuniform reaches, invariably found in natural channels, if the energy gradient is modified to reflect only the losses due to boundary friction. The energy equation for a reach of nonuniform channel between two adjacent sections is

$$(h + h_v)_1 = (h + h_v)_2 + (h_f)_{1,2} + k(\Delta h_v)_{1,2} \quad (3)$$

where:

h	=	Elevation of water surface at the respective sections above a common datum;
h_v	=	Velocity head at the respective section = $\alpha V^2/2g$;
h_f	=	Energy loss due to boundary friction in the reach;
h_v	=	Upstream velocity head minus the downstream velocity head;
$k(\Delta h_v)$	=	Energy loss due to acceleration or deceleration of velocity in a contracting or expanding reach; and
k	=	A coefficient taken to be zero for contracting reaches and 0.5 for expanding reaches.

In computing the values of n the value of α , the velocity head coefficient, can be considered to be 1.00.

The friction slope S to be used in the Manning equation is thus defined as

$$S = \frac{h_f}{L} = \frac{\Delta h + \Delta h_v - k(\Delta h_v)}{L} \quad (4)$$

where: Δh is the difference in water-surface elevation at the two sections and L is the length of the reach.

CALIFORNIA SALMONID STREAM HABITAT RESTORATION MANUAL

In using the Manning equation the quantity $(1.486/n)AR^{2/3}$, called conveyance and designated K , is computed for each section. The mean conveyance in the reach between any two sections is computed as the geometric mean of the conveyance of the two sections. The discharge equation in terms of conveyance is:

$$Q = \sqrt{K_1 K_2 S} \quad (5)$$

where: S is the friction slope as previously defined.

The average value of the Manning "n" is computed for each reach from the measured discharge, the water surface profile, and the hydraulic properties of the reach as defined by the number of cross sections measured. The following equation, which is based on the same concepts and definitions as equations 2 through 5, is used to compute the value of Manning "n". The equation is applicable to a multi-section reach of M cross sections which are designated 1, 2, 3, ... $M-1$, M .

$$n = \frac{1.486}{Q} \sqrt{\frac{(h + h_v)_1 - (h + h_v)_M - [(k\Delta h_v)_{1,2} + (k\Delta h_v)_{2,3} + \dots + (k\Delta h_v)_{(M-1),M}]}{\frac{L_{1,2}}{Z_1 Z_2} + \frac{L_{2,3}}{Z_2 Z_3} + \dots + \frac{L_{(M-1),M}}{Z_{(M-1)} Z_M}}} \quad (6)$$

where: $Z = AR^{2/3}$ and other quantities are as previously defined.

Computation Procedure

Determine the channel discharge (Q) by using flow meters or any other standard methodology. The flow measurement should correspond to the discharge at which the water surface profile measurements are taken at the selected cross sections.

Prepare a planimetric map of the project reach of the channel by plotting data from a field survey of the site. The location of all cross sections measured should be shown on the map. The waters edge, corresponding to measured discharges, can also be shown on the map for clarification. The distance between cross sections (L) can be determined from the map or derived directly from survey field notes.

CALIFORNIA SALMONID STREAM HABITAT RESTORATION MANUAL

Develop the water surface profile along each bank for the measured discharge by plotting the elevation and stationing of the water edge. The water surface elevations (h) at each cross section can be taken as the average of the water surface elevation on each bank as determined from the water surface profiles.

Plot the channel cross sections from the field survey data. Show the measured water surface elevation on each cross section corresponding to the measured flow.

From the cross section plots measure the wetted perimeter (P), the wetted area (A), and calculate the hydraulic radius ($R=A/P$) and $Z (=AR^{2/3})$.

From the measured flow and wetted area, calculate the average velocity for the cross section ($V=Q/A$) and the velocity head ($h_v=V^2/2g$). Calculate deceleration losses between cross sections ($k\Delta h_v$).

Substitute the measured and calculated values of Q , L , Z , h , h_v , and $k\Delta h_v$ into equation 6 and solve for "n".

REFERENCES

- Brater, Ernest F. and King, Horace Williams. 1976. Handbook of Hydraulics, Sixth Edition, McGraw-Hill, USA.
- Barnes, H.H., Jr. 1967. Roughness Characteristics Of Natural Channels. United States Geological Survey Water Supply Paper 1849.
- Bray, D.I. 1982. Regime equations for gravel-bed rivers. Pages 517-542 *in* Gravel-Bed Rivers, ed. by R.D. Hey, J.C. Bathurst and C.R. Thorne, John Wiley and Sons, Chichester.
- Chow, V.T. 1959. Open Channel Hydraulics. McGraw-Hill Book Co., New York, 680 pp.
- Dunne, T. and L.B. Leopold. 1978. Water In Environmental Planning. W.H. Freeman and Company, New York, 877 pp.
- Dury, G.H. 1973. Magnitude-frequency analysis and channel morphometry. Pages 91-121 *in* Fluvial Geomorphology, State University of New York, Binghamton, Publications in Geomorphology, ed. by M. Morisawa.
- Graf, W.H. 1971. Hydraulics Of Sediment Transport. McGraw-Hill Book Co., New York, 513 pp.
- Hey, R.D. 1982. Design equations for mobile gravel-bed rivers. Pages 553-574 *in* Gravel-Bed Rivers, ed. by R.D. Hey, J.C. Bathurst, and C.R. Thorne, John Wiley and Sons, Chichester.

CALIFORNIA SALMONID STREAM HABITAT RESTORATION MANUAL

- Inter-Fluve, Inc. 1984. In-house computer design program for in-channel modifications. Inter-Fluve, Inc. Bozeman, MT.
- Jackson, W.L. and B.P. Van Haveren. 1984. Design for a stable channel in coarse alluvium for riparian zone restoration. *Water Resources Bulletin*, 20: 695-703.
- Jarrett, R.D. 1985. Determination Of Roughness Coefficients For Streams In Colorado. USGS Water Resources Investigation Report 85-4004, 54 pp.
- Mott, R.L. 1979. *Applied Fluid Mechanics*. Charles Merrill Publishing Co. Columbus, Ohio, 405 pp.
- Rundquist, L.A., N.E. Bradley, J.E. Baldrige, P.D. Hampton, T.R. Jennings and M.R. Joyce. 1986. Best Management Practices For Placer Mining, Reference Manual and Technical Report. Entrix, Inc., for Alaska Department of Fish and Game, 459 pp.
- United States Army Corps of Engineers. 1970. *Hydraulic Design Of Flood Control Channels*. EM 1110-2-1601.
- Williams, G.P., 1986. River meanders and channel size. *Journal of Hydrology*, 88:147-164.
- Wolman, M.G. and J.P. Miller. 1960. Magnitude and frequency of forces in geomorphic processes. *Journal of Geology*, 68:54-74.
- Wolman, M.G. and L.B. Leopold. 1957. *River Floodplains: Some Observations on Their Formation*. U.S. Geological Survey Paper 282C.
- Yu, B. and M.G. Wolman. 1987. Some dynamic aspects of river geometry. *Water Resources Research*, 23:501-509.

CALIFORNIA SALMONID STREAM HABITAT RESTORATION MANUAL

APPENDIX I.

COMPUTER PROGRAMS AND DATABASE STRUCTURES

Documentation for Data Entry and Analysis Program

The Inland Fisheries Division of the Department of Fish and Game has developed an IBM compatible PC program for entering, storing, analyzing, editing, and creating uniform summary tables of fishery habitat and large woody debris inventory data. These programs are written and compiled in dBASE IV language and distributed as public domain software ("Preface, p. i" has information on obtaining a program diskette. The program's menu driven design exactly follows protocol established in this manual and will output data summary tables as illustrated in this manual. The following description is to facilitate use of the program.

Program Hardware Requirements. The program requires a hard disk with a least 3.0 megabytes (mb) of available space and an IBM-compatible PC with at least a 286 processor and 1 mb of random access memory (RAM). The program will run quite slowly under the minimum system configuration. Minimum recommended system configuration is a 386 processor with 4 mb of RAM. The habitat inventory program supports use of a HP Laserjet printer. The large woody debris program supports use of HP Laserjet and dot matrix printers. Neither program supports a mouse.

Installing the Program. The program is distributed on a single 3.5-inch high-density floppy disk in a ZIP file named HABITAT (version). Insert the program diskette in drive A or B and type `INSTAL_A` or `INSTAL_B` at the drive prompt. A directory called HABITAT will be created on your hard drive and all necessary program files will be copied to the HABITAT directory. When installation is complete you will be prompted to start the program by typing `HABITAT8` at the `C>` prompt. Follow the instructions on the screen to use the desired programs. Store the diskette in a safe location for backup purposes.

Starting the Habitat Inventory or Large Woody Debris program. The program is started by typing `HABITAT8` at the `C:\HABITAT>` prompt and pressing `<Enter>`. Follow the menu driven instructions to access the appropriate program.

The program creates new dBASE-type database files to contain the fishery habitat inventory or the large woody debris data, and stores the files in the program directory, although they may also be directed for storage on floppy disks. In order to edit, analyze, or print existing database files, the files must first reside in the program directory (`C:\HABITAT`) so the program to find them.

Main menu. Selections are made by using the arrow keys to move the highlighted selection bar and then pressing `<Enter>`.

CALIFORNIA SALMONID STREAM HABITAT RESTORATION MANUAL

1. Habitat Typing Program

Create a New Database. This option allows for the creation of a new database. Enter a one to eight character name for the new file with no extension. New database files will be created in the dBASE IV format and located in the current directory. In order to use an existing database file, it must be located in the same directory as the program and it must match the dBASE IV structure created by this program.

Use an Existing Database. This option presents a list of existing database files in the current directory. Choose one by highlighting it, but make sure it is a file of the appropriate structure. Do not use LWD.DBF or NODELETE.DBF.

Exit Program. This selection is the only exit from the program.

Action menu. This menu offers different actions that may be taken with the selected database.

Add. This option allows for adding additional records. The entry screen follows the format of the Habitat Inventory Data Form data sheets present in Part III of the manual. Follow the on-screen instructions for navigating through the screens. Many of the specific data entry lines have error checking routines that limit the range as type of data that may be entered. Pressing <F10> will allow access to dBASE pull-down menus, at the top of the screen. Hold down the <Ctrl> key and press the <End> key to exit when finished entering data.

Edit. This option allows reviewing and editing any records or data in the currently selected database. The default screen shows one record at a time, but you may toggle between this screen and a multiple record or BROWSE screen by pressing <F2>. Press <F10> to access the dBASE pull down menus at the top of the screen and <Ctrl><End> to exit.

Print. This option allows selection of nine different tables of summarized data for printing on HP Laserjet compatible printers.

View. Allows selection of 10 different screen views of summarized data from the currently selected database.

Export. Allows selection of data summaries to be converted to Lotus spreadsheet formats and copied to the hard disk or floppy disks.

File. Allows copying your currently selected database to a floppy disk or deletion of selected database files from the hard disk. **DO NOT DELETE FILES NAMED NODELETE.DBF OR LWD.DBF**

CALIFORNIA SALMONID STREAM HABITAT RESTORATION MANUAL

Return to Main Menu. This option allows returning to the main menu to select a different database for action.

Documentation for Geographic Information Systems Analysis

The Inland Fisheries Division of the Department of Fish and Game has developed a data model and Geographic Information System (GIS) interface for viewing, querying and displaying the HABITAT data. The Department of Fish and Game has used software licensed by Environmental Systems Research Institute⁸ (ESRI). This software has specific hardware requirements. It is beyond the scope of this manual to discuss GIS, the complexity of ESRI software, or the hardware requirements of the software. However, we would like to provide a brief outline for how GIS analysis of the HABITAT data can be developed. A data model was developed in ESRI's Arc/Info⁸ software (see <http://www.esri.com>). The interface was developed in ESRI's ArcView⁸ software. This section describes the ArcView interface and functionality. More information on the data model is available on the Internet at:

<http://www.esri.com/base/common/userconf/proc96/TO250/PAP218/p218.htm>

Byrne, Michael. 1996. California Salmonid Stream Habitat Inventory: A Dynamic Segmentation Application. Proceedings from the 1996 Arc/Info Users Conference.

For more information on Geographic Information Systems in general refer to:

Environmental Systems Research Institute. 1992. Understanding GIS The Arc/Info Method. ESRI. Redlands CA;

or

Environmental Systems Research Institute. 1996. ArcView GIS the Geographic Information System for Everyone. ESRI. Redlands CA.

Documentation For ArcView Habitat Inventory Project

An extension has been created in ESRI's ArcView 3.0⁸ software for spacial analysis of stream habitat inventory databases created with the HABITAT program. Before these databases can be used, they need to be converted using the dynamic segmentation process and saved as ArcView⁸ shape files (see above data model reference for this process). For more accuracy, these files should be calibrated in Arc/Info⁸ to correct for stream length discrepancies. No other files are required, however, other GIS coverages are often useful and can be added to the views if needed.

The ArcView⁸ extension, habitat.avx, can be acquired from the Inland Fisheries Division anonymous ftp site. The site is located at maphost.dfg.ca.gov/pub/outgoing/ifd. This file must be placed in the extension directory located with the ArcView⁸ software. This is usually `c:\esri\av_gis30\arcview\ext32\`, but might be different depending on where ArcView⁸ was loaded. To use the extension, open ArcView and go to the file menu. Choose the Extension option, and HABITAT Extension should appear among the available choices. Check the box for this option.

CALIFORNIA SALMONID STREAM HABITAT RESTORATION MANUAL

Now notice a new menu on the Project Menu Bar. The new menu is Stream Views and has the following options:

Stream Views

Rearing Habitat

Riparian Veg./Bank Comp.

Spawning Habitat

Miscellaneous

All Of The Above

Switch to Combining Views (or Switch to Separating Views)

Options

Choosing "Rearing Habitat" will create a view for the stream of your choice containing themes that portray the rearing habitat. Before the view is created, it is necessary to choose a dynamically segmented stream shape file. It is possible to choose more than one stream at a time by holding down the <SHIFT> key. The next two menu choices do the same for riparian vegetation/bank composition and spawning habitat. "Miscellaneous" creates themes not belonging in any of the other views. "All Of The Above" creates all four views for the stream(s) of your choice.

When multiple streams are chosen (by holding down the <SHIFT> key), the project allows these stream views to be combined into one view, or made into separate views for each stream. The last choice in the menu simply changes between "Switch to Combining Views" and "Switch to Separating Views" when it is chosen. Combining streams into one view is a useful way to create a single view for an entire watershed.

The base project contains a view named "**** Included Themes - Don't Delete ****", with no themes in it. This view needs to stay in the project for the project to function properly. It can be left empty or filled with themes that automatically will be included in the views created from the "Stream Views" menu. This is a useful way to include streams, roads, vegetation, cities, fish restoration sites, or other pertinent coverages to each view. To create a custom habitat inventory project, save it under a different name with themes added to this view. However, none of the automated views should be in the project when it is saved.

The "Options" menu item allows the user to specify which themes, based on the habitat inventory, are created in the various views. A list of themes is presented with an "X" marking the themes that will be created. Select one or more from the list to toggle the theme(s) on/off. Any new views created will only include the themes that are marked with an "X". The default setting is all themes turned on. However, any changes made will be saved automatically for subsequent sessions.

It is not recommended to save the project after the automated views are created. In most situations, the time required to create new views, is only slightly greater than the time required to open a project in which the automated views were saved. This is because most of the time goes toward querying the database, which needs to be done regardless. However, if subsequent additions or modifications were made to the automated views, it would be necessary to save these changes if needed in the future. In this case, save the project under a different name (e.g. "Mill.apr").

CALIFORNIA SALMONID STREAM HABITAT RESTORATION MANUAL

Problems and Potential Problems:

There is a limit as to how many views a project can hold. Depending on computer memory and speed, there may be a long wait or inadequate memory to create views for many streams at once. A little experimentation and caution is advised before choosing many streams simultaneously.

For many of the themes, habitat inventories conducted with the 10% sample protocol display as less complete than those conducted with 100% methodology. If this is not recognized, it could lead to misleading information.

Because the habitat units are small in relation to the stream as a whole, it is often necessary to zoom in to see the individual habitat units. However, zooming in often results in only part of the stream being displayed on the monitor, making it difficult to do spacial analysis for the entire stream.

Often, only one theme can be turned on at a time because the various themes display the same stream line in different ways. However, other streams combined in the same view or included with themes such as roads, boundaries, etc. can be displayed simultaneously.

Some themes created have an empty table and display nothing when turned on. This was left as is for the information it contains. For example an empty "Backwater Pools" theme indicates no backwater pools in the stream or an empty "LGR W/ Gravel/Small Cobble" theme indicates little or no spawning habitat.

Fish Habitat Inventory Database

When a new database is created using the HABITAT program, the following database structure is created (see Part III).

Field	Field Name	Type	Width	Field Description
1	STREAM	Character	25	Stream name
2	LEGAL	Character	11	Legal description using township, range, section
3	LATD	Numeric	2	Latitude in degrees at stream mouth
4	LATM	Numeric	2	Latitude in minutes
5	LATS	Numeric	4	Latitude in seconds
6	LOND	Numeric	3	Longitude in degrees at stream mouth
7	LONM	Numeric	2	Longitude in minutes
8	LONS	Numeric	4	Longitude in seconds
9	QUAD	Character	10	7.5 minute USGS quadrangle name
10	RF3RCHID	Character	17	EPA reach file number
11	PNAME	Character	30	EPA stream name
12	PNMCD	Character	11	EPA stream name unique code at mouth
13	SURVEYORS	Character	25	Names of data collection team
14	DLAT	Numeric	8	Decimal degrees latitude at stream mouth
15	DLONG	Numeric	8	Decimal degrees longitude at stream mouth

**CALIFORNIA SALMONID STREAM
HABITAT RESTORATION MANUAL**

Field	Field Name	Type	Width	Field Description
16	FLOW	Character	6	Stream flow in cfs
17	DATE	Date	8	Sample date in day/month/year
18	CHANNLTYPE	Character	4	Channel type, Rosgen system
19	REACH	Character	2	Stream reach number, starting at mouth
20	TIME	Character	5	Time of sample collection start
21	WATER	Character	3	Water temperature in degrees Fahrenheit
22	AIR	Character	3	Air temperature in degrees Fahrenheit
23	HABUNITNUM	Character	16	Habitat unit no. starting at stream mouth
24	HABTYPE	Character	9	Habitat type as defined in manual
25	SIDENCHANL	Character	3	Side channel habitat type
26	MEANLENGTH	Numeric	8	Length (ft) of each habitat type
27	STRM_LGNTH	Numeric	7	Total stream length (ft) from mouth
28	MEAN_WIDTH	Numeric	6	Mean width (ft) of each habitat unit
29	MEAN_DEPTH	Numeric	5	Mean depth (ft) for each habitat unit
30	MAX_DEPTH	Numeric	5	Maximum depth (ft) for each habitat unit
31	AREA	Numeric	10	Area (sq-ft) for each habitat unit
32	DPTPLCREST	Numeric	4	Depth of pool tail crest (ft), pools only
33	RESPOLDPTH	Numeric	5	Residual pool depth (ft), pools only
34	VOLUME	Numeric	10	Water volume (cu-ft) for every unit
35	RESPOOLVOL	Numeric	10	Residual pool volume (cu-ft)
36	EMBEDDED	Numeric	1	Measure cobble embeddedness 1-4
37	SHEL_VALUE	Numeric	1	Estimated shelter value per manual
38	PCT_COVER	Numeric	3	% of unit providing fish cover
39	SHELT_RATN	Numeric	3	Shelter value x % fish cover
40	UNDER_BANK	Numeric	3	% cover provided by undercut banks
41	PER_SWD	Numeric	3	% cover provided by small woody debris
42	PER_LWD	Numeric	3	% cover provided by large woody debris
43	PER_ROOT	Numeric	3	% cover provided by root masses
44	TERR_VEG	Numeric	3	% cover provided by terrestrial vegetation
45	AQUA_VEG	Numeric	3	% cover provided by aquatic vegetation
46	WHITEWATER	Numeric	3	% cover provided by white water
47	PER_BOLDER	Numeric	3	% cover provided by boulders
48	BEDROCKLED	Numeric	3	Dominate substrate bedrock
49	SILT_CLAY	Numeric	1	Dominate substrate silt-clay
50	SAND	Numeric	1	Dominate substrate sand
51	GRAVEL	Numeric	1	Dominate substrate gravel
52	SMCOBBLE	Numeric	1	Dominate substrate small cobble
53	LGCOBBLE	Numeric	1	Dominate substrate large cobble
54	BOLDER	Numeric	1	Dominate substrate boulder
55	BEDROCK	Numeric	1	Dominate substrate bedrock
56	PCT_EXPOSE	Numeric	3	% exposed substrate in unit
57	PCT_CANOPY	Numeric	3	% vegetation canopy
58	PCT_DECID	Numeric	3	% deciduous canopy

CALIFORNIA SALMONID STREAM HABITAT RESTORATION MANUAL

Field	Field Name	Type	Width	Field Description
59	PCT_CONIF	Numeric	3	% coniferous canopy
60	RTBKCOMP	Numeric	1	Composition of right bank
61	RTBKDOMINT	Numeric	1	Dominant vegetation on right bank
62	PCT_RTBKCO	Numeric	3	% right bank vegetative cover
63	LFBKCOMP	Numeric	1	Composition of left bank
64	LFBKDOMINT	Numeric	1	Dominant vegetation on left bank
65	PCT_LFBKCO	Numeric	3	% left bank vegetative cover
66	CODE	Character	1	Field reserved for GIS reference
67	MEMO	Memo	10	Notes on stream and channel problems

2. Large Woody Debris Program

The LWD program creates one record within the database for each stream sample section or for each page of the LWD Survey Form. The entire LWD survey is contained within a single dBASE file.

Enter Data from LWD Survey Form. This option prompts the user for the year of survey and a four digit file name that identifies the stream surveyed. The program assigns the first four digits of the file name beginning with “LW” + year (e.g. LW97MILL.DBF). The first data entry screen prompts the user to enter stream background information. The remaining screens prompt for data entry. Data entry screens are organized to correspond with the LWD survey form format for ease of data entry.

Edit Records in Database. On selection of this option the user is prompted to select a stream for data editing from the drop down list. Be certain that the file name selected begins with “LW + year”. Before editing, check that the stream name and PNMCD correspond with the correct data sheet. Use caution when editing, the program allows the user to directly access the database.

Select a Stream for Summary Report. This option allows the user to select a stream for a printed summary of each sample section. On selection of this option, the user is first prompted to identify the type of printer in use. The next screen prompts for the name of the stream for summary data. Since many streams have the same name, and several sample sections and reaches usually exist within each stream, the user is prompted to select the appropriate stream and sample section from the list presented. The user has a choice of printing one or both of the summary tables for the selected stream reach.

Exit Program. The only exit from the program is through this selection.

CALIFORNIA SALMONID STREAM HABITAT RESTORATION MANUAL

Large Woody Debris Stream and Riparian Survey Database

The following database was developed to store data developed when conducting a large woody debris stream and riparian survey as explained in Part 3 of this manual. The database structure has been standardized to facilitate data incorporation into the DFG statewide fishery GIS. To insure compatibility with the GIS, modifications to the structure should only be made by adding fields to the end of the database.

Field	Field Name	Type	Width	Field Description
1	STREAM	Character	20	Name of stream
2	SAMPLE	Character	2	Number of sample section in reach
3	REACH	Character	2	Number of reach
4	BASIN	Character	15	River basin or drainage system
5	DATE	Date	8	Date of survey
6	SMPLFEET	Numeric	3	Length of sample section in feet
7	TWNSHP	Character	3	Township at mouth
8	RANGE	Character	3	Range at mouth
9	SECTION	Character	2	Section number at number
10	START	Numeric	5	Feet from landmark at reach start
11	STOP	Numeric	5	Feet from landmark at reach end
12	LENGTH	Numeric	5	Total length of reach
13	QUAD	Character	15	Name of USGS 7.5 minute quad
14	LAT_D	Character	2	Degrees of latitude
15	LAT_M	Character	2	Minutes of latitude
16	LAT_S	Character	3	Seconds of latitude
17	LON_D	Character	3	Degrees of longitude
18	LON_M	Character	2	Minutes of longitude
19	LON_S	Character	4	Seconds of longitude
20	GRDIENT	Numeric	3	Water slope in percent
21	CHNTYPE	Character	2	Channel type
22	FLOW	Numeric	5	Stream flow in cfs
23	SID	Numeric	3	Obsolete field, no longer used
24	LANDMARK	Character	20	Permanent landmark or reference
25	A_TEMP	Character	3	Air temperature
26	W_TEMP	Character	3	Water temperature
27	MWETW	Numeric	2	Mean wetted stream width
28	MBFW	Numeric	2	Mean bankfull width
29	MBFD	Numeric	4	Mean bankfull depth
30	MFPW	Numeric	3	Mean flood prone area width
31	SINU	Character	3	Sinuosity ratio
32	SUBST_1_3	Character	3	% substrate with boulders 1-3 feet
33	SUBST_G3	Character	3	% substrate with boulders > 3 feet
34	RBSLOPE	Character	3	Right bank slope in percent
35	RBVEG	Character	3	Dominate vegetation on right bank

**CALIFORNIA SALMONID STREAM
HABITAT RESTORATION MANUAL**

Field	Field Name	Type	Width	Field Description
36	STRMVEG	Character	3	Dominate vegetation in stream
37	LBSLOPE	Character	3	Left bank slope in percent
38	LBVEG	Character	3	Dominate vegetation on left bank
39	RBDD1L20	Numeric	2	Rt bank dead/down 1-2'dia. <20'long
40	RBDS1L20	Numeric	2	Rt bk dead/standing 1-2'dia. <20'long
41	RBPER1L20	Numeric	2	Rt bank perched 1-2'dia. <20'long
42	RBRWDD1	Numeric	2	Rt bank root wad dead/down 1-2'dia.
43	RBRWDS1	Numeric	2	Rt bank root wad dead/standing 1-2'dia.
44	RBRWPR1	Numeric	2	Rt bank root wad perched 1-2'dia.
45	STRMDD1L20	Numeric	2	Stream dead/down 1-2'dia. <20'long
46	STRMDS1L20	Numeric	2	Stream dead/standing 1-2'dia. <20'long
47	STMPER1L20	Numeric	2	Not used; no instream "perched" LWD
48	STRWDD1	Numeric	2	Stream root wad dead/down 1-2'dia.
49	STRWDS1	Numeric	2	Stream root wad dead/standing 1-2'dia.
50	LBDD1L20	Numeric	2	Lt bank dead/down 1-2'dia. <20'long
51	LBDS1L20	Numeric	2	Lt bk dead/standing 1-2'dia. <20'long
52	LBPER1L20	Numeric	2	Lt bank perched 1-2'dia. <20'long
53	LBRWDD1	Numeric	2	Lt bank root wad dead/down 1-2' dia.
54	LBRWDS1	Numeric	2	Lt bank root wad dead/standing 1-2'dia.
55	LBRWPR1	Numeric	2	Lt bank root wad perched 1-2' dia.
56	RBDD1G20	Numeric	2	Rt bank dead/down 1-2'dia. >20'long
57	RBDS1G20	Numeric	2	Rt bk dead/standing 1-2'dia. >20'long
58	RBPER1G20	Numeric	2	Rt bank perched 1-2'dia. >20'long
59	RBLVC1G20	Numeric	2	Rt bank live conifer 1-2'dia. >20'long
60	RBLVD1G20	Numeric	3	Rt bank live deciduous 1-2'dia. >20'long
61	STRMDD1G20	Numeric	2	Stream dead/down 1-2'dia. >20'long
62	STRMDS1G20	Numeric	2	Stream dead/standing 1-2'dia. >20'long
63	STMPER1G20	Numeric	2	Not used; no instream "perched" LWD
64	STMLVC1G20	Numeric	2	Stream live conifer 1-2dia.>20'long
65	STMLVD1G20	Numeric	2	Stream live deciduous 1-2dia.>20'long
66	LBDD1G20	Numeric	2	Lt bank dead/down 1-2dia.>20'long
67	LBDS1G20	Numeric	2	Lt bank dead/standing 1-2dia.>20'long
68	LBPER1G20	Numeric	2	Lt bk perched 1-2dia.>20'long
69	LBLVC1G20	Numeric	3	Lt bank live conifer 1-2dia.>20'long
70	LBLVD1G20	Numeric	3	Lt bank live deciduous 1-2dia.>20'long
71	RBDD2L20	Numeric	2	Rt bank dead/down 2-3dia. <20'long
72	RBDS2L20	Numeric	2	Rt bk dead/standing 2-3dia.<20'long
73	RBPER2L20	Numeric	2	Rt bank perched 2-3dia. <20'long
74	RBRWDD2	Numeric	2	Rt bank root wad dead/down 2-3' dia
75	RBRWDS2	Numeric	2	Rt bank root wad dead/standing 2-3'dia.
76	RBRWPR2	Numeric	2	Rt bank root wad perched 2-3' dia
77	STRMDD2L20	Numeric	2	Stream dead/down 2-3dia. <20'long
78	STRMDS2L20	Numeric	2	Stream dead/standing 2-3dia.<20'long

**CALIFORNIA SALMONID STREAM
HABITAT RESTORATION MANUAL**

Field	Field Name	Type	Width	Field Description
79	STMPER2L20	Numeric	2	Not used; no instream "perched" LWD
80	STRWDD2	Numeric	2	Stream root wad dead/down 2-3' dia
81	STRWDS2	Numeric	2	Stream root wad dead/standing 2-3'dia
82	LBDD2L20	Numeric	2	Lt bank dead/down 2-3dia. <20'long
83	LBDS2L20	Numeric	2	Lt bk dead/standing 2-3dia.<20'long
84	LBPER2L20	Numeric	2	Lt bank perched 2-3dia. <20'long
85	LBRWDD2	Numeric	2	Lt bank root wad dead/down 2-3' dia.
86	LBRWDS2	Numeric	2	Lt bank root wad dead/standing 2-3'dia.
87	LBRWPR2	Numeric	2	Lt bank root wad perched 2-3' dia
88	RBDD2G20	Numeric	2	Rt bank dead/down 2-3dia. >20'long
89	RBDS2G20	Numeric	2	Rt bk dead/standing 2-3dia.>20'long
90	RBPER2G20	Numeric	2	Rt bank perched 2-3dia. >20'long
91	RBLVC2G20	Numeric	3	Rt bank live conifer 2-3dia.>20'long
92	RBLVD2G20	Numeric	3	Rt bank live deciduous 2-3dia.>20'long
93	STRMDD2G20	Numeric	2	Stream dead/down 2-3dia. >20'long
94	STRMDS2G20	Numeric	2	Stream dead/standing 2-3dia.>20'long
95	STMPER2G20	Numeric	2	Not used; no instream "perched" LWD
96	STMLVC2G20	Numeric	2	Stream live conifer 2-3dia.>20'long
97	STMLVD2G20	Numeric	2	Stream live deciduous 2-3dia.>20'l
98	LBDD2G20	Numeric	2	Lt bank dead/down 2-3dia.>20'long
99	LBDS2G20	Numeric	2	Lt bank dead/standing 2-3dia.>20'long
100	LBPER2G20	Numeric	2	Lt bk perched 2-3dia.>20'long
101	LBLVC2G20	Numeric	3	Lt bank live conifer 2-3dia.>20'long
102	LBLVD2G20	Numeric	2	Lt bank live deciduous 2-3dia.>20'long
103	RBDD3L20	Numeric	2	Rt bank dead/down 3-4dia. <20'long
104	RBDS3L20	Numeric	2	Rt bk dead/standing 3-4dia.<20'long
105	RBPER3L20	Numeric	2	Rt bank perched 3-4dia. <20'long
106	RBRWDD3	Numeric	2	Rt bank root wad dead/down 3-4'dia.
107	RBRWDS3	Numeric	2	Rt bank root wad dead/standing 3-4'd
108	RBRWPR3	Numeric	2	Rt bank root wad perched 3-4'dia.
109	STRMDD3L20	Numeric	2	Stream dead/down 3-4dia. <20'long
110	STRMDS3L20	Numeric	2	Stream dead/standing 3-4dia.<20'long
111	STMPER3L20	Numeric	2	Not used; no instream "perched" LWD
112	STRWDD3	Numeric	2	Stream root wad dead/down 3-4'dia.
113	STRWDS3	Numeric	2	Stream root wad dead/standing 3-4'dia.
114	LBDD3L20	Numeric	2	Lt bank dead/down 3-4dia. <20'long
115	LBDS3L20	Numeric	2	Lt bk dead/standing 3-4dia.<20'long
116	LBPER3L20	Numeric	2	Lt bank perched 3-4dia. <20'long
117	LBRWDD3	Numeric	2	Lt bank root wad dead/down 3-4'dia
118	LBRWDS3	Numeric	2	Lt bank root wad dead/standing 3-4'dia.
119	LBRWPR3	Numeric	2	Lt bank root wad perched 3-4'dia
120	RBDD3G20	Numeric	2	Rt bank dead/down 3-4dia. >20'long
121	RBDS3G20	Numeric	2	Rt bk dead/standing 3-4dia.>20'long

**CALIFORNIA SALMONID STREAM
HABITAT RESTORATION MANUAL**

Field	Field Name	Type	Width	Field Description
122	RBPER3G20	Numeric	2	Rt bank perched 3-4dia. >20'long
123	RBLVC3G20	Numeric	2	Rt bank live conifer 3-4dia.>20'long
124	RBLVD3G20	Numeric	2	Rt bank live deciduous 3-4'd>20'long
125	STRMDD3G20	Numeric	2	Stream dead/down 3-4dia. >20'long
126	STRMDS3G20	Numeric	2	Stream dead/standing 3-4dia.>20'long
127	STMPER3G20	Numeric	2	Not used; no instream "perched" LWD
128	STMLVC3G20	Numeric	2	Stream live conifer 3-4dia.>20'long
129	STMLVD3G20	Numeric	2	Stream live deciduous 3-4dia.>20'long
130	LBDD3G20	Numeric	2	Lt bank dead/down 3-4dia.>20'long
131	LBDS3G20	Numeric	2	Lt bank dead/standing 3-4dia.>20'long
132	LBPER3G20	Numeric	2	Lt bk perched 3-4dia.>20'long
133	LBLVC3G20	Numeric	3	Lt bank live conifer 3-4dia.>20'long
134	LBLVD3G20	Numeric	3	Lt bank live deciduous 3-4dia.>20'long
135	RBDD4L20	Numeric	2	Rt bank dead/down > 4dia. <20'long
136	RBDS4L20	Numeric	2	Rt bk dead/standing > 4dia.<20'long
137	RBPER4L20	Numeric	2	Rt bank perched > 4dia. <20'long
138	RBRWDD4	Numeric	2	Rt bank root wad dead/down >4'dia
139	RBRWDS4	Numeric	2	Rt bank root wad dead/standing >4'dia.
140	RBRWPR4	Numeric	2	Rt bank root wad perched >4'dia
141	STRMDD4L20	Numeric	2	Stream dead/down >4dia. <20'long
142	STRMDS4L20	Numeric	2	Stream dead/standing >4dia.<20'long
143	STMPER4L20	Numeric	2	Not used; no instream "perched" LWD
144	STRWDD4	Numeric	2	Stream root wad dead/down >4'dia
145	STRWDS4	Numeric	2	Stream root wad dead/standing >4'dia
146	LBDD4L20	Numeric	2	Lt bank dead/down >4dia. <20'long
147	LBDS4L20	Numeric	2	Lt bk dead/standing >4dia.<20'long
148	LBPER4L20	Numeric	2	Lt bank perched >4dia. <20'long
149	LBRWDD4	Numeric	2	Lt bank root wad dead/down >4'dia
150	LBRWDS4	Numeric	2	Lt bank root wad dead/standing >4'd
151	LBRWPR4	Numeric	2	Lt bank root wad perched >4'dia
152	RBDD4G20	Numeric	2	Rt bank dead/down >4dia. >20'long
153	RBDS4G20	Numeric	2	Rt bk dead/standing >4dia.>20'long
154	RBPER4G20	Numeric	2	Rt bank perched >4dia. >20'long
155	RBLVC4G20	Numeric	2	Rt bank live conifer >4dia.>20'len
156	RBLVD4G20	Numeric	2	Rt bank live deciduous >4dia.>20'l
157	STRMDD4G20	Numeric	2	Stream dead/down >4dia. >20'long
158	STRMDS4G20	Numeric	2	Stream dead/standing >4dia.>20'long
159	STMPER4G20	Numeric	2	Not used; no instream "perched" LWD
160	STMLVC4G20	Numeric	2	Stream live conifer >4dia.>20'l
161	STMLVD4G20	Numeric	2	Stream live deciduous >4dia.>20'l
162	LBDD4G20	Numeric	2	Lt bank dead/down >4dia.>20'long
163	LBDS4G20	Numeric	2	Lt bank dead/standing >4dia.>20'long
164	LBPER4G20	Numeric	2	Lt bk perched >4dia.>20'long

CALIFORNIA SALMONID STREAM HABITAT RESTORATION MANUAL

Field	Field Name	Type	Width	Field Description
165	LBLVC4G20	Numeric	2	Lt bank live conifer >4dia.>20'long
166	LBLVD4G20	Numeric	2	Lt bank live deciduous >4dia.>20'long
167	COMMENT	Memo	10	Comments or remarks

Biological Survey Database

The following database was developed to store species occurrence data collected during stream surveys. The database structure was standardized by a technical committee of fishery scientists representing government, industry and private consultants so that the results would be compatible with a statewide geographic information system (GIS). To insure compatibility with the GIS, modifications to the structure should only be made by adding fields to the end of the database.

A database file named BIOSAMPL.DBF is on the floppy disk that accompanies this manual. This is a stand-alone database and is included in the compiled HABITAT program.

Field	Field Name	Type	Width	Field Description
1	SID	Numeric	4	Obsolete field, no longer used
2	BASIN	Character	10	Name of major river basin
3	STREAM	Character	20	Stream name
4	QUAD	Character	10	7.5-minute USGS quadrangle name
5	OBSERVERS	Character	20	Observers or data collectors
6	DATE	Date	8	Sample date in day/month/year
7	LATD	Numeric	2	Latitude in degrees at stream mouth
8	LATM	Numeric	2	Latitude in minutes
9	LATS	Numeric	4	Latitude in seconds
10	LOND	Numeric	3	Longitude in degrees at stream mouth
11	LONM	Numeric	2	Longitude in minutes
12	LONS	Numeric	4	Longitude in seconds
13	UTM_REG	Numeric	2	UTM zone coordinate
14	UTM_N	Numeric	10	UTM north distance in meters
15	UTM_E	Numeric	10	UTM east distance in meters
16	SITE	Character	2	Sample site # (numbered upstream from mouth)
17	DIST	Numeric	5	Distance upstream from mouth in feet
18	TIME	Numeric	4	Time of sampling
19	AIRTEMP	Numeric	2	Air temperature F°
20	H2O_TEMP	Numeric	2	Water temperature F°
21	H2O_VISIBL	Numeric	2	Water visibility in feet
22	FLOW_CFS	Numeric	4	Stream flow in cubic feet per second
23	REACH	Numeric	3	Stream reach no. from habitat typing data
24	HABTYP1	Numeric	3	Primary habitat type of sample unit
25	HABTYP2	Numeric	3	Secondary habitat type of sample unit
26	HABTYP3	Numeric	3	Tertiary habitat type of sample unit

**CALIFORNIA SALMONID STREAM
HABITAT RESTORATION MANUAL**

Field	Field Name	Type	Width	Field Description
27	SAMPL_DIST	Numeric	3	Sampled stream distance in ft.
28	SAMPL_AREA	Numeric	4	Surface area of sampled area sq.ft.
29	EFFORT	Numeric	4	Minutes of electrofishing, seining, etc.
30	METHOD	Character	12	Sample by SNORKEL, BANK, ELECTROFISH, or SEINE
31	TROUT_YOY	Numeric	3	Number of all trout young-of-year
32	STHD_1YR	Numeric	3	Number of 1+ steelhead
33	STHD_2YR	Numeric	3	Number of 2+ steelhead
34	COHO_YOY	Numeric	3	Number of young-of-year coho
35	COHO_1YR	Numeric	3	Number of 1+ coho
36	CHINOOK	Numeric	3	Number of chinook
37	SQUAW_YOY	Numeric	3	Number of squawfish young-of-year
38	SQUAW_1YR	Numeric	3	Number of squawfish adults
39	SUCKER	Numeric	3	Number of suckers, all species
40	ROACH	Numeric	3	Number of roach
41	DACE	Numeric	3	Number of dace
42	SCULPIN	Numeric	3	Number of sculpin
43	STICKLEBAC	Numeric	3	Number of stickleback
44	CRAYFISH	Numeric	3	Number of crayfish
45	SHRIMP	Numeric	3	No. of <u>Syncaris pacifica</u> Federal listed
46	LAMP_LARV	Numeric	3	Number of lamprey ammocetes
47	LAMPREY	Numeric	3	Number of lamprey adults
48	RAINBOW	Numeric	3	Number of rainbow trout
49	CCT_1YR	Numeric	3	Number of cutthroat 1yr+
50	CCT_ADULT	Numeric	3	Number of cutthroat adults
51	SALAMAND	Numeric	3	Number of salamanders of all species
52	TADPOLES	Numeric	3	Number of tadpoles of all species
53	FROGS	Numeric	3	Number of adult frogs of all species
54	WARM_H2O	Character	10	Warmwater species by abbrev.
55	TISUESAMPL	Character	1	Tissue samples collected: "Y" or "N"

Examples of optional additional species fields:

Field	Field Name	Type	Width	Field Description
56	GOLDEN	Numeric	3	Number of golden trout
57	BROWNTROUT	Numeric	3	Number of brown trout
58	BROOKTROUT	Numeric	3	Number of brook trout
59	LAKETROUT	Numeric	3	Number of lake trout
60	WHITEFISH	Numeric	3	Number of whitefish
61	L_REDSIDE	Numeric	3	Number of Lahontan reddsides
62	KOKANEE	Numeric	3	Number of kokanee

CALIFORNIA SALMONID STREAM HABITAT RESTORATION MANUAL

Watershed Overview Database

The following database was developed to store data developed when conducting a watershed overview as explained in Part II of this manual. The database structure has been standardized to facilitate data incorporation into the DFG statewide fishery GIS. To insure compatibility with the GIS, modifications to the structure should only be made by adding fields to the end of the database.

A database file named WATERSHD.DBF is on the floppy disk that accompanies this manual. This is standalone database and included in the compiled HABITAT program.

Field	Field Name	Type	Width	Field Description
1	DATE	Character	8	Data collection date
2	RESEARCHER	Character	20	Investigators names
3	STREAM	Character	20	Stream name from USGS quadrangle
4	TRIB1_TO	Character	15	Receiving stream name
5	TRIB2_TO	Character	15	Name of stream receiving "Trib 1_To"
6	TRIB3_TO	Character	15	Continue down stream-web to the ocean
7	COUNTY	Character	12	County of stream mouth location
8	QUAD	Character	15	Name of USGS quad at stream mouth
9	USGS_QUAD2	Character	15	Name of USGS quad containing stream
10	USGS_QUAD3	Character	15	Name of USGS quad containing stream
11	USGS_QUAD4	Character	15	Name of USGS quad containing stream
12	PNAME	Character	20	EPA reach file designated stream name
13	PNMCD	Character	11	EPA reach file unique code at stream mouth
14	LEGAL	Character	11	Township, Range, Section at stream mouth
15	LATD	Numeric	2	Latitude in degrees at stream mouth
16	LATM	Numeric	2	Latitude in minutes
17	LATS	Numeric	4	Latitude in seconds
18	LOND	Numeric	3	Longitude in degrees at stream mouth
19	LONM	Numeric	2	Longitude in minutes
20	LONS	Numeric	4	Longitude in seconds
21	ACCESS_VIA	Memo	10	Access description
22	HYDROUNIT	Character	8	Hydrologic unit number
23	AERIALS	Logical	1	Are aerial photos available Y or N
24	AERIAL_COM	Memo	10	Comment on aerial photos
25	PRE_SURVE	Logical	1	Previous survey information Y or N
26	SURVEYINFO	Memo	10	Location of previous survey info
27	CR_ORDER	Character	1	Stream order
28	TOT_LENGTH	Numeric	6	Total stream length in miles
29	FED_LENGTH	Numeric	6	Stream length on Federal land
30	STA_LENGTH	Numeric	6	Stream length on State land
31	PRV_LENGTH	Numeric	6	Stream length on private land
32	LENGTH_COM	Memo	10	Comment on stream length

**CALIFORNIA SALMONID STREAM
HABITAT RESTORATION MANUAL**

Field	Field Name	Type	Width	Field Description
33	INVENTORY	Logical	1	Fish habitat inventory complete?
34	INVEN_DATE	Character	16	Fish habitat inventory date
35	INVEN_LGTH	Numeric	6	Fish habitat inventory length
36	END_LATD	Numeric	2	End of survey, degrees of latitude
37	END_LATM	Numeric	2	End of survey, minutes of lat.
38	END_LATS	Numeric	4	End of survey, seconds of lat.
39	END_LONGD	Numeric	3	End of survey, degrees of longitude
40	END_LONGM	Numeric	2	End of survey, minutes of long.
41	END_LONGS	Numeric	4	End of survey, seconds of long.
42	INVENT_COM	Memo	10	Comment on fish habitat inventory
43	E_O_ANADRO	Logical	1	Did survey reach end of anadromy?
44	DIST_CHIN	Numeric	5	Distance where chinook were found
45	DIST_COHO	Numeric	5	Distance where coho were found
46	DIST_SH	Numeric	5	Distance where steelhead were found
47	DIST_S_SH	Numeric	5	Distance summer steelhead were found
48	BASIN_AREA	Numeric	8	Watershed area in square miles
49	PCNT_FED	Numeric	3	% watershed in Federal ownership
50	PCNT_STA	Numeric	3	% watershed in State ownership
51	PCNT_PRV	Numeric	3	% watershed in private ownership
52	AREA_COM	Memo	10	Comment on watershed area
53	BASE_FLOW	Numeric	7	Base stream flow in cfs
54	MOUTH_ELEV	Numeric	5	Elevation of stream mouth
55	HEAD_ELEV	Numeric	5	Elevation of stream headwaters
56	LAKE_NUM	Numeric	3	Number of lakes in watershed
57	LAKE_AREA	Numeric	5	Area of all lakes in watershed
58	FISH_CHIN	Logical	1	Chinook present in watershed?
59	FISH_COHO	Logical	1	Coho present in watershed?
60	FISH_SH	Logical	1	Steelhead present in watershed?
61	FISH_SH_S	Logical	1	Summer steelhead present?
62	FISH_SQ_S	Logical	1	Squawfish present?
63	FISH_OTHER	Logical	1	Are other species present?
64	FISH_COM	Memo	10	Comments about fish community
65	ETS_SPECIE	Logical	1	Threatened & endangered spp. present?
66	ETS_COM	Memo	10	Comment about T&E species
67	ENDEM_PR	Logical	1	Are endemic fish stocks present?
68	ENDEM_COM	Memo	10	Comment on endemic fish stocks
69	MAN_CW_NAT	Logical	1	Natural stock coldwater fishery
70	MAN_CW_MIX	Logical	1	Mixed stock coldwater fishery
71	MAN_AN_NAT	Logical	1	Natural stock anadromous fishery
72	MAN_AN_MIX	Logical	1	Mixed stock anadromous fishery
73	MAN_WW	Logical	1	Warm water fishery
74	MAN_OTHER	Logical	1	Other management objectives
75	FLOW_DATA	Logical	1	Is stream flow data available?

**CALIFORNIA SALMONID STREAM
HABITAT RESTORATION MANUAL**

Field	Field Name	Type	Width	Field Description
76	FLOW_COM	Memo	10	Comment on stream flow data
77	WQUAL_DATA	Logical	1	Is water quality data available?
78	WQUAL_COM	Memo	10	Comment on water quality data
79	LAND_1A	Logical	1	Land use code - paved roads
80	LAND_1B	Logical	1	Land use code - unpaved roads
81	LAND_2	Logical	1	Land use code - timber harvest
82	LAND_3A	Logical	1	Land use code - open pit mining
83	LAND_3B	Logical	1	Land use code - hard rock mining
84	LAND_3C	Logical	1	Land use code - suction dredging
85	LAND_4A	Logical	1	Land use code - grazing
86	LAND_4B	Logical	1	Land use code - cultivation
87	LAND_5A	Logical	1	Land use code - Federal wilderness
88	LAND_5B	Logical	1	Land use - State park or wilderness
89	LAND_6A	Logical	1	Land use code - large hydro project
90	LAND_6B	Logical	1	Land use code - small hydro project
91	LAND_6C1	Logical	1	Out of basin water diversion
92	LAND_6C2	Logical	1	Land use - in basin water diversion
93	LAND_7A	Logical	1	Land use code - ski areas
94	LAND_7B	Logical	1	Land use code - campgrounds
95	LAND_8	Logical	1	Land use code - dispersed recreation
96	LAND_9	Logical	1	Land use code - urbanization
97	LAND_10	Logical	1	Land use - off highway vehicle area
98	LAND_COM	Memo	10	Land use comments
99	GEN_COM	Memo	10	General comments

Carcass Survey Database

The following database was developed to store data collected during carcass surveys using the methodology explained in Part IV of this manual. The database structure has been standardized to facilitate data incorporation into the DFG statewide fishery GIS. To insure compatibility with the GIS, modifications to the structure should only be made by adding fields to the end of the database.

A database file named CARCASS.DBF is on the floppy disk that accompanies this manual. This is a stand-alone database and is included in the compiled HABITAT program.

**CALIFORNIA SALMONID STREAM
HABITAT RESTORATION MANUAL**

Field	Field Name	Type	Width	Field Description
1	DATE	Date	8	Date of survey
2	BASIN	Character	15	Drainage basin name
3	COUNTY	Character	3	County at creek mouth
4	PNAME	Character	20	EPA reach file designated stream name
5	PNMCD	Character	11	EPA reach file unique code at stream mouth
6	STREAM	Character	15	Stream name on USGS quadrangle
7	LEGAL	Character	15	Township, Range, and Section at mouth
8	LATD	Numeric	2	Latitude degrees at stream mouth
9	LATM	Numeric	2	Latitude minutes at stream mouth
10	LATS	Numeric	4	Latitude seconds at stream mouth
11	LOND	Numeric	3	Longitude degrees at stream mouth
12	LONM	Numeric	2	Longitude minutes at stream mouth
13	LONS	Numeric	4	Longitude seconds at stream mouth
14	ST_LAT_D	Numeric	2	Lat. degrees at downstream start
15	ST_LAT_M	Numeric	2	Lat. minutes at downstream start
16	ST_LAT_S	Numeric	4	Lat. seconds at downstream start
17	ST_LON_D	Numeric	3	Lon. degrees at downstream start
18	ST_LON_M	Numeric	2	Lon. minutes at downstream start
19	ST_LON_S	Numeric	4	Lon. seconds at downstream start
20	END_LAT_D	Numeric	2	Lat. degrees at upstream end
21	END_LAT_M	Numeric	2	Lat. minutes at upstream end
22	END_LAT_S	Numeric	4	Lat. seconds at upstream end
23	END_LON_D	Numeric	3	Lon. degrees at upstream end
24	END_LON_M	Numeric	2	Lon. minutes at upstream end
25	END_LON_S	Numeric	4	Lon. seconds at upstream end
26	MILES	Numeric	4	Approximate miles of survey
27	NLCHIN	Numeric	3	No. of live chinook
28	NLCOHO	Numeric	3	No. of live coho
29	NLSTH	Numeric	3	No. of live steelhead
30	NLOTHER	Numeric	3	No. of live unknown species
31	NFCHINM	Numeric	3	No. of fresh male chinook carcasses
32	NFCHINF	Numeric	3	No. of fresh female chinook carcasses
33	NFCOHOM	Numeric	3	No. of fresh male coho carcasses
34	NFCOHOF	Numeric	3	No. of fresh female coho carcasses
35	NFSTH	Numeric	3	No. of fresh steelhead carcasses
36	NNFCHIN	Numeric	3	No. of non-fresh chinook carcasses
37	NNFCOHO	Numeric	3	No. of non-fresh coho carcasses
38	NNFSTH	Numeric	3	No. of non-fresh steelhead carcasses
39	NNFOTHER	Numeric	3	No. of non-fresh non-ID'ed carcasses
40	CWT_REC	Numeric	3	No. of coded-wire tag recoveries
41	REDDS	Numeric	3	Number of redds counted

CALIFORNIA SALMONID STREAM HABITAT RESTORATION MANUAL

Habitat Project Evaluation Survey Database

The following databases were developed to store habitat project evaluation data collected during evaluation surveys. To insure compatibility with the GIS, modifications to the structure should only be made by adding fields to the end of the database.

Database files named EVLDATA.DBF and EVALGEN.DBF are on the floppy disk that accompanies this manual.

Database File: EVALGEN.DBF General project information

Field	Field Name	Type	Width	Field Description
1	STREAM	Character	20	Name of stream
2	BASIN	Character	15	Name of drainage or system
3	PNAME	Character	20	EPA reach file designated stream name
4	PNMCD	Character	11	EPA reach file unique stream
5	EVALUATOR	Character	15	Name of evaluator
6	DATE	Date	8	Date of evaluation
7	CNTRNO	Character	7	Contract number of project
8	FY	Character	5	Fiscal year of contract
9	SOURCE	Character	10	Funding source
10	CONTACT	Character	12	DFG contact person
11	CONTRACTOR	Character	15	Project contractor
12	MULTI_LOC	Logical	1	Multiple site contract? (Y/N)
13	AMOUNT	Character	6	Dollar amount of project
14	P_OWNER	Character	15	Property owner
15	ACCESS	Character	50	Description of access to site
16	CHANNLTYPE	Character	3	Channel type(s) in project reach
17	STR_ORDER	Character	1	Stream order of project stream
18	DRAIN_AREA	Numeric	5	Drainage area in sq. mi.
19	QUAD	Character	15	Name of USGS 7.5 min. quad. map
20	LATD	Numeric	2	Degrees of latitude
21	LATM	Numeric	2	Minutes of latitude
22	LATS	Numeric	4	Seconds of latitude
23	LOND	Numeric	3	Degrees of longitude
24	LONM	Numeric	2	Minutes of longitude
25	LONS	Numeric	4	Seconds of longitude
26	P_COMPL	Character	8	Month and year project completed (mm/yy)
27	LAST_EVAL	Character	8	Month and year of last evaluation (mm/yy)
28	PREPROJ	Logical	1	Preproject data available
29	PRE_LOC	Character	20	Location of preproject data
30	ASBUILT	Logical	1	As-built plans available
31	ASBILT_LOC	Character	20	Location of as_built plans
32	NCONST	Numeric	2	Number of structures built

CALIFORNIA SALMONID STREAM HABITAT RESTORATION MANUAL

Field	Field Name	Type	Width	Field Description
33	NEVAL	Numeric	2	Number of structures observed
34	PAGES	Character	2	Number of evaluation pages
35	COMMENTS	Memo		Comments of project/evaluation

Database File: EVLDATA.DBF Structure or site evaluation.

Field	Field Name	Type	Width	Field Description
1	STREAM	Character	20	Name of stream
2	BASIN	Character	15	Name of drainage or basin
3	PNAME	Character	20	EPA reach file designated stream name
4	PNMCD	Character	11	EPA reach file unique code at mouth
5	DATE	Date	8	Date of evaluation
6	CNTRNO	Character	7	Contract number of project
7	FY	Character	5	Fiscal year of contract
8	RPOINT	Character	15	Reference point in stream
9	DLAT	Numeric	6	Decimal degrees latitude at mouth
10	DLONG	Numeric	7	Decimal degrees longitude at mouth
11	RPOINT_FT	Numeric	5	Feet from reference point
12	FT	Numeric	5	Stream length of habitat type(s) effected
13	CHANNLTYPE	Character	4	Channel type in project area
14	OBJECTV	Character	1	Restoration objective of structure
15	TYPE	Character	3	Type of habitat structure
16	OBJ_RATE	Character	1	Rating of objective
17	OBJ_COM	Character	150	Comments of objective rating
18	CON_RATE	Character	1	Rating of condition
19	CON_COM	Character	150	Comments of condition rating
20	PROBLEM1	Numeric	2	Structural problems
21	PROBLEM2	Numeric	2	Structural problems
22	PROBLEM3	Numeric	2	Structural problems
23	PROBLEM4	Numeric	2	Structural problems
24	PROB_COM	Character	150	Comments of structural problems
25	MAN_MOD	Logical	1	Maintenance or repair recommended
26	IMPROVE	Logical	1	Improvements to increase effectiveness
27	MOD_COM	Character	150	Comments on maintenance or improvements
28	HABTYP	Character	4	Habitat type associated with structure
29	WIDTH	Numeric	3	Bankfull stream width
30	MAXPOOL	Numeric	4	Maximum depth of pool
31	TAILCRST	Numeric	4	Depth of the pool tail crest
32	COMPLX	Numeric	1	Shelter complexity
33	COVER	Numeric	2	Percent cover
34	FISH	Character	150	Comments of fish observed
35	PHOTO	Character	1	Photo taken (Y/N)

CALIFORNIA SALMONID STREAM HABITAT RESTORATION MANUAL

APPENDIX J.

STREAM INVENTORY REPORT

JUGHANDLE CREEK

INTRODUCTION

A stream inventory was conducted during the fall of 1996 on Jughandle Creek. The survey began at the confluence with an intermittent left bank tributary in the center of section 5; 55 minutes walking distance downstream from the rock quarry. The inventory was conducted in two parts: habitat inventory and biological inventory. The objective of the habitat inventory was to document the habitat available to anadromous salmonids in Jughandle Creek. The objective of the biological inventory was to document the presence and distribution of juvenile salmonid species.

The objective of this report is to document the current habitat conditions, and recommend options for the potential enhancement of habitat for coho salmon and steelhead trout. Recommendations for habitat improvement activities are based upon target habitat values suitable for salmonids in California's north coast streams.

WATERSHED OVERVIEW

Jughandle Creek is a tributary to the Pacific Ocean, located in Mendocino County, California (Map 1). Jughandle Creek's legal description at the confluence with the Pacific Ocean is T18N R18W S36. Its location is 39E22'37" north latitude and 123E48'55" west longitude. Jughandle Creek is a first order stream and has approximately 4.3 miles of blue line stream according to the USGS Fort Bragg, Mathison Peak, and Mendocino 7.5 minute quadrangles. Jughandle Creek drains a watershed of approximately 3.1 square miles. Elevations range from sea level at the mouth of the creek to 800 feet in the headwater areas. Redwood forest dominates the watershed. The watershed is primarily owned by the Jackson Demonstration State Forest and is managed by the California Department of Forestry and Fire Protection for timber production. Vehicle access exists via Road 530. Foot access is available from the rock quarry at the bottom of the road.

METHODS

The habitat inventory conducted in Jughandle Creek follows the methodology presented in the *California Salmonid Stream Habitat Restoration Manual* (Flosi and Reynolds, 1991 rev. 1994). The California Conservation Corps (CCC) Technical Advisors and Watershed Stewards Project/AmeriCorps (WSP/AmeriCorps) Members that conducted the inventory were trained in standardized habitat inventory methods by the California Department of Fish and Game (DFG). This inventory was conducted by a two-person team.

CALIFORNIA SALMONID STREAM HABITAT RESTORATION MANUAL

SAMPLING STRATEGY

The inventory uses a method that samples approximately 10% of the habitat units within the survey reach (Hopelain, 1994). All habitat units included in the survey are classified according to habitat type and their lengths are measured. All pool units are measured for maximum depth. Habitat unit types encountered for the first time are further measured for all the parameters and characteristics on the field form. Additionally, from the ten habitat units on each field form page, one is randomly selected for complete measurement.

HABITAT INVENTORY COMPONENTS

A standardized habitat inventory form has been developed for use in California stream surveys and can be found in the *California Salmonid Stream Habitat Restoration Manual*. This form was used in Jughandle Creek to record measurements and observations. There are nine components to the inventory form.

1. Flow:

Flow is measured in cubic feet per second (cfs) at the bottom of the stream survey reach using standard flow measuring equipment, if available. In some cases flows are estimated.

2. Channel Type:

Channel typing is conducted according to the classification system developed and revised by David Rosgen (1985 rev. 1994). This methodology is described in the *California Salmonid Stream Habitat Restoration Manual*. Channel typing is conducted simultaneously with habitat typing and follows a standard form to record measurements and observations. There are five measured parameters used to determine channel type: 1) water slope gradient, 2) entrenchment, 3) width/depth ratio, 4) substrate composition, and 5) sinuosity.

3. Temperatures:

Both water and air temperatures are measured and recorded at every tenth habitat unit. The time of the measurement is also recorded. Both temperatures are taken in degrees Fahrenheit at the middle of the habitat unit and within one foot of the water surface.

4. Habitat Type:

Habitat typing uses the 24 habitat classification types defined by McCain and others (1988). Habitat units are numbered sequentially and assigned a type identification number selected from a standard list of 24 habitat types. Dewatered units are labeled "dry". Jughandle Creek habitat typing used standard basin level measurement criteria. These parameters require that the minimum length of a described habitat unit must be equal to or greater than the stream's mean wetted width. Channel dimensions were measured using hip chains, tape measures, and stadia rods. All units were measured for mean length; additionally, the first occurrence of each unit type and a randomly selected 10% subset of all units were sampled for all features on the sampling form (Hopelain,

CALIFORNIA SALMONID STREAM HABITAT RESTORATION MANUAL

1995). Pool tail crest depth at each pool unit was measured in the thalweg. All measurements were in feet to the nearest tenth.

5. Embeddedness:

The depth of embeddedness of the cobbles in pool tail-out reaches is measured by the percent of the cobble that is surrounded or buried by fine sediment. In Jughandle Creek, embeddedness was ocularly estimated. The values were recorded using the following ranges: 0 - 25% (value 1), 26 - 50% (value 2), 51 - 75% (value 3) and 76 - 100% (value 4). Additionally, a value of 5 was assigned to tail-outs deemed unsuited for spawning due to inappropriate substrate particle size, having a bedrock tail-out, or other considerations.

6. Shelter Rating:

Instream shelter is composed of those elements within a stream channel that provide salmonids protection from predation, reduce water velocities so fish can rest and conserve energy, and allow separation of territorial units to reduce density related competition. The shelter rating is calculated for each fully-described habitat unit by multiplying shelter value and percent cover. Using an overhead view, a quantitative estimate of the percentage of the habitat unit covered is made. All cover is then classified according to a list of nine cover types. In Jughandle Creek, a standard qualitative shelter value of 0 (none), 1 (low), 2 (medium), or 3 (high) was assigned according to the complexity of the cover. Thus, shelter ratings can range from 0-300 and are expressed as mean values by habitat types within a stream.

7. Substrate Composition:

Substrate composition ranges from silt/clay sized particles to boulders and bedrock elements. In all fully-described habitat units, dominant and sub-dominant substrate elements were ocularly estimated using a list of seven size classes and recorded as a one and two respectively.

8. Canopy:

Stream canopy density was estimated using modified handheld spherical densimeters as described in the *California Salmonid Stream Habitat Restoration Manual*. Canopy density relates to the amount of stream shaded from the sun. In Jughandle Creek, an estimate of the percentage of the habitat unit covered by canopy was made from the end of approximately every third unit in addition to every fully-described unit, giving an approximate 30% sub-sample. In addition, the area of canopy was estimated ocularly into percentages of coniferous or deciduous trees.

CALIFORNIA SALMONID STREAM HABITAT RESTORATION MANUAL

9. Bank Composition and Vegetation:

Bank composition elements range from bedrock to bare soil. However, the stream banks are usually covered with grass, brush, or trees. These factors influence the ability of stream banks to withstand winter flows. In Jughandle Creek, the dominant composition type and the dominant vegetation type of both the right and left banks for each fully-described unit were selected from the habitat inventory form. Additionally, the percent of each bank covered by vegetation was estimated and recorded.

BIOLOGICAL INVENTORY

Biological sampling during stream inventory is used to determine fish species and their distribution in the stream. In Jughandle Creek fish presence was observed from the stream banks, and three sites were electrofished using one Smith-Root Model 12 electrofisher. These sampling techniques are discussed in the *California Salmonid Stream Habitat Restoration Manual*.

DATA ANALYSIS

Data from the habitat inventory form are entered into Habitat, a dBASE 4.2 data entry program developed by Tim Curtis, Inland Fisheries Division, California Department of Fish and Game. This program processes and summarizes the data, and produces the following six tables:

- Riffle, flatwater, and pool habitat types
- Habitat types and measured parameters
- Pool types
- Maximum pool depths by habitat types
- Dominant substrates by habitat types
- Mean percent shelter by habitat types

Graphics are produced from the tables using Quattro Pro. Graphics developed for Jughandle Creek include:

- Riffle, flatwater, pool habitats by percent occurrence
- Riffle, flatwater, pool habitats by total length
- Total habitat types by percent occurrence
- Pool types by percent occurrence
- Total pools by maximum depths
- Embeddedness
- Pool cover by cover type
- Dominant substrate in low gradient riffles
- Percent canopy
- Bank composition by composition type
- Bank vegetation by vegetation type

CALIFORNIA SALMONID STREAM HABITAT RESTORATION MANUAL

HABITAT INVENTORY RESULTS

* ALL TABLES AND GRAPHS ARE LOCATED AT THE END OF THE REPORT *

The habitat inventory of October 28, 29, and 30, 1996, was conducted by Craig Mesman (CCC) and Dionne Wrights (WSP/AmeriCorps). The total length of the stream surveyed was 8,327 feet with an additional 265 feet of side channel.

Flow was estimated to be 0.35 cfs during the survey period with a Marsh-McBirney Model 2000 flowmeter on October 30, 1996.

Jughandle Creek is an F4 channel type for 8,028 feet and an A4 channel type for 299 feet of stream reach surveyed. F4 channels are entrenched, meandering, riffle/pool channels on low gradients with high width/depth ratios and gravel-dominant substrates. A4 channel types are steep, narrow, cascading, step pool streams with high energy/debris transport associated with depositional soils and gravel-dominant substrates.

Water temperatures taken during the survey period ranged from 48 to 50 degrees Fahrenheit. Air temperatures ranged from 42 to 56 degrees Fahrenheit.

Table 1 summarizes the Level II riffle, flatwater, and pool habitat types. Based on frequency of **occurrence** there were 38% pool units, 31% riffle units, 29% flatwater units, and 2% was dry (Graph 1). Based on total **length** of Level II habitat types there were 44% flatwater units, 32% pool units, 22% riffle units, and 1% was dry (Graph 2).

Twelve Level IV habitat types were identified (Table 2). The most frequent habitat types by percent **occurrence** were low gradient riffle units, 30%; mid-channel pool units, 25%; and step run units, 17% (Graph 3). Based on percent total **length**, step run units made up 34%, mid-channel pool units 22%, and low gradient riffle units 21%.

A total of 127 pools were identified (Table 3). Main channel pools were most frequently encountered at 69% and comprised 76% of the total length of all pools (Graph 4).

Table 4 is a summary of maximum pool depths by pool habitat types. Pool quality for salmonids increases with depth. Thirty-four of one hundred and twenty-seven pools (26.8%) had a depth of two feet or greater (Graph 5).

The depth of cobble embeddedness was estimated at pool tail-outs. Of the 127 pool tail-outs measured, 6 had a value of 1 (5%); 27 had a value of 2 (21%); 29 had a value of 3 (23%); 30 had a value of 4 (24%); and 35 had a value of 5 (27%), or were not suitable for spawning (Graph 6). On this scale, a value of 1 indicates the highest quality of spawning substrate.

CALIFORNIA SALMONID STREAM HABITAT RESTORATION MANUAL

A shelter rating was calculated for each habitat unit and expressed as a mean value for each habitat type within the survey using a scale of 0-300. Pool habitat types had a mean shelter rating of 37, and flatwater habitats had a mean shelter rating of 32 (Table 1). Of the pool types, the backwater pools had the highest mean shelter rating at 48. Main channel pools had a mean shelter rating of 37 (Table 3).

Table 5 summarizes mean percent cover by habitat type. Small woody debris is the dominant cover type in Jughandle Creek. Boulders are the next most common cover type. Graph 7 describes the pool cover in Jughandle Creek.

Table 6 summarizes the dominant substrate by habitat type. Gravel was the dominant substrate observed in 82% of the low gradient riffles measured. Small cobble was the next most frequently observed dominant substrate type and occurred in 18% of the low gradient riffles (Graph 8).

The mean percent canopy density for the stream reach surveyed was 98%. The mean percentages of deciduous and coniferous trees were 64% and 36%, respectively. Graph 9 describes the canopy in Jughandle Creek.

For the stream reach surveyed, the mean percent right bank vegetated was 93.8%. The mean percent left bank vegetated was 93.2%. The dominant elements composing the structure of the stream banks consisted of 3.3% bedrock, 3.3% boulder, 45.6% cobble/gravel, and 45.6% sand/silt/clay (Graph 10). Brush was the dominant vegetation type observed in 53.3% of the units surveyed. Additionally, 6.5% of the units surveyed had deciduous trees as the dominant vegetation type, and 13.0% had coniferous trees as the dominant vegetation, including down trees, logs, and root wads (Graph 11).

BIOLOGICAL INVENTORY RESULTS

Three sites were electrofished on October 24, 1996, in Jughandle Creek. The sites were sampled by Craig Mesman and Dionne Wrights.

The first site sampled included habitat units 243 through 251, a step run, low gradient riffle, step run, lateral scour pool - root wad enhanced, low gradient riffle, mid-channel pool, low gradient riffle and step run, approximately 6,869 feet from the beginning of the survey and above an LDA approximately 134 feet long. The site yielded a total of 5 steelhead.

The second site included habitat units 292 through 298, a plunge pool, low gradient riffle, run, mid-channel pool, step run, low gradient riffle and plunge pool, approximately 7,866 feet from the beginning of the survey. The site yielded a total of 7 steelhead.

The third site sampled was the mid-channel pool at the end of the survey 8,327 feet from the beginning, and 275 feet above the confluence with a left bank tributary that enters Jughandle Creek at the upper end. The site yielded 1 steelhead.

CALIFORNIA SALMONID STREAM HABITAT RESTORATION MANUAL

DISCUSSION

Jughandle Creek is an F4 channel type for the first 8,028 feet of stream surveyed and an A4 for the remaining 299 feet. The suitability of F4 and A4 channel types for fish habitat improvement structures is as follows: F4 channels are good for bank placed boulders, single and opposing wing deflectors, channel constrictors and log cover. A4 channels are good for bank-placed boulders, fair for low stage weirs, opposing wing deflectors and log cover and poor for medium stage weirs, boulder clusters, single wing deflectors and log cover.

The water temperatures recorded on the survey days October 28 through 30, 1996, ranged from 48 to 50 degrees Fahrenheit. Air temperatures ranged from 42 to 56 degrees Fahrenheit. This is a good water temperature range for salmonids. To make any further conclusions, temperatures would need to be monitored throughout the warm summer months, and more extensive biological sampling would need to be conducted.

Flatwater habitat types comprised 44% of the total **length** of this survey, riffles 22%, and pools 32%. The pools are relatively shallow, with only 34 of the 127 (27%) pools having a maximum depth greater than 2 feet. In general, pool enhancement projects are considered when primary pools comprise less than 40% of the length of total stream habitat. In first and second order streams, a primary pool is defined to have a maximum depth of at least two feet, occupy at least half the width of the low flow channel, and be as long as the low flow channel width. Installing structures that will increase or deepen pool habitat is recommended.

Ninety-four of the 127 pool tail-outs measured had embeddedness ratings of 3, 4 or 5. Only 6 had a 1 rating. Cobble embeddedness measured to be 25% or less, a rating of 1, is considered to indicate good quality spawning substrate for salmon and steelhead. In Jughandle Creek, sediment sources should be mapped and rated according to their potential sediment yields, and control measures should be taken.

The mean shelter rating for pools was low with a rating of 37. The shelter rating in the flatwater habitats was slightly lower at 32. A pool shelter rating of approximately 100 is desirable. The relatively small amount of cover that now exists is being provided primarily by small woody debris in all habitat types. Additionally, boulders contribute a small amount. Log and root wad cover structure in the pool and flatwater habitats are needed to improve both summer and winter salmonid habitat. Log cover structure provides rearing fry with protection from predation, rest from water velocity, and also divides territorial units to reduce density related competition.

All of the low gradient riffles measured had gravel or small cobble as the dominant substrate. This is generally considered good for spawning salmonids.

The mean percent canopy density for the stream was 98%. This is a relatively high percentage of canopy. In general, revegetation projects are considered when canopy density is less than 80%.

CALIFORNIA SALMONID STREAM HABITAT RESTORATION MANUAL

The percentage of right and left bank covered with vegetation was high at 93.8% and 93.2%, respectively. In areas of stream bank erosion or where bank vegetation is not at acceptable levels, planting endemic species of coniferous and deciduous trees, in conjunction with bank stabilization, is recommended.

RECOMMENDATIONS

- 1) Jughandle Creek should be managed as an anadromous, natural production stream.
- 2) Increase woody cover in the pools and flatwater habitat units. Most of the existing cover is from small woody debris. Adding high quality complexity with woody cover is desirable and in some areas the material is locally available.
- 3) Active and potential sediment sources related to the road system need to be identified, mapped, and treated according to their potential for sediment yield to the stream and its tributaries.
- 4) Where feasible, design and engineer pool enhancement structures to increase the number of pools. This must be done where the banks are stable or in conjunction with stream bank armor to prevent erosion.
- 5) The limited water temperature data available suggest that maximum temperatures are within the acceptable range for juvenile salmonids. To establish more complete and meaningful temperature regime information, 24-hour monitoring during the July and August temperature extreme period should be performed for 3 to 5 years.

COMMENTS AND LANDMARKS

The following landmarks and possible problem sites were noted. All distances are approximate and taken from the beginning of the survey reach.

- 0' Begin survey at confluence with intermittent left bank tributary (center of section 5). This is a 55 minute walk downstream from the "rock pit." Channel type is an F4.
- 61' Flow in tributary is <0.10 cubic feet per second (cfs). Accessible to fish.
- 1,259' Flowing right bank tributary <0.10 cfs. Very steep and full of wood. Not accessible to anadromous fish.
- 1,727' Stump on right bank with a sign: "State Park Boundary."
- 2,256' Left bank tributary, <0.10 cfs. Small, narrow, steep. Not accessible to anadromous fish.
- 2,755' Log debris accumulation (LDA), 15' long x 15' wide x 4' high retains approximately 3' deep gravel. Not a barrier.

**CALIFORNIA SALMONID STREAM
HABITAT RESTORATION MANUAL**

- 3,326' Left bank tributary at top of unit, <0.10 cfs. Small, no distinct channel. Not accessible to anadromous fish. Large ravine.
- 4,009' Four logs parallel to flow catching small woody debris and filling the channel. Retaining little sediment. Right bank tributary comes into top of unit. Flow is <0.10 cfs. Narrow, steep, with no distinct channel.
- 4,748' Garbage in the stream and on left bank.
- 4,855' Left bank tributary, <0.10 cfs. Flows through a rock pit. Not accessible to anadromous fish. Lined with garbage.
- 4,957' Garbage ends here.
- 5,184' Right bank tributary <0.10 cfs. Narrow with no distinct channel. Not accessible to anadromous fish.
- 5,533' Small woody debris (SWD) accumulation clogs channel.
- 5,642' Left bank tributary, <0.10 cfs. Narrow, steep, and not accessible to anadromous fish. Tributary flows through a large ravine.
- 5,710' Corrugated metal pipe under old road crossing, 8' wide x 8' high. Good condition.
- 6,025' LDA, 15' long x 25' wide x 5' high. Retaining sediment 4' high.
- 6,227' Three logs parallel to flow retaining gravel approximately 3' deep. Not a barrier.
- 6,380' Root wad retaining 4.5' of sediment.
- 6,443' Gradient begins increasing here.
- 6,692' Water percolates through woody debris and gravel. Debris retains 5' of gravel.
- 6,706' LDA retaining 4.5' of sediment creating a 4.5' high jump.
- 6,734' LDA retaining 3' of sediment and creating a 3.5 high jump.
- 6,784' LDA across channel. The material came from a slide and fallen trees.
- 6,869' First electrofishing site.
- 6,897' Channel back to low gradient with gravel dominant.
- 7,130' Right bank tributary.

CALIFORNIA SALMONID STREAM HABITAT RESTORATION MANUAL

- 7,798' LDA, 8' long x 15' wide x 4' high. Retaining sediment, may hinder passage.
- 7,866' Second electrofishing site.
- 8,052' Channel type changes to A4.
- 8,056' Left bank tributary, <0.10 cfs. Steep, narrow, not accessible to anadromous fish.
- 8,232' LDA, retaining sediment 5' deep and creating a 5' high jump.
- 8,327' End of Survey. Last electrofishing site and the highest fish observation. The channel above here becomes narrow and choked with vegetation. The channel is also steep (4-10%). The stream flow is also becoming intermittent.

CALIFORNIA SALMONID STREAM HABITAT RESTORATION MANUAL

Table J-1. Summary of riffle, flatwater, and pool habitat types.

JUGHANDLE CREEK														
Drainage: PACIFIC OCEAN														
Table 1 - SUMMARY OF RIFFLE, FLATWATER, AND POOL HABITAT TYPES														
Survey Dates: 10/28/96 to 10/30/96														
Confluence Location: QUAD: FORT BRAGG LEGAL DESCRIPTION:														
LATITUDE: 39°22'37" LONGITUDE: 123°48'55"														
HABITAT UNITS	UNITS FULLY MEASURED	HABITAT TYPE	HABITAT PERCENT OCCURRENCE	MEAN LENGTH (ft.)	TOTAL LENGTH (ft.)	PERCENT TOTAL LENGTH	MEAN WIDTH (ft.)	MEAN DEPTH (ft.)	MEAN AREA (sq. ft.)	ESTIMATED TOTAL AREA (sq. ft.)	MEAN VOLUME (cu. ft.)	ESTIMATED TOTAL VOLUME (cu. ft.)	MEAN RESIDUAL POOL VOL (cu. ft.)	MEAN SHELTER RATING
103	13	RIFFLE	31	18	1900	22	5.5	0.2	114	11762	35	3573	0	12
97	10	FLATWATER	29	39	3819	44	6.6	0.4	171	16560	61	5878	0	32
127	23	POOL	38	22	2761	32	7.7	0.8	169	21409	153	19471	118	37
5	0	DRY	2	15	74	1	0.0	0.0	0	0	0	0	0	0
1	0	CULVERT	0	38	38	0	0.0	0.0	0	0	0	0	0	0
TOTAL UNITS	TOTAL UNITS				TOTAL LENGTH (ft.)				TOTAL AREA (sq. ft.)		TOTAL VOL. (cu. ft.)			
333	46				8592				49731		28921			

CALIFORNIA SALMONID STREAM HABITAT RESTORATION MANUAL

Table J-2. Summary of habitat types and measured parameters.

JUGHANDLE CREEK																
Drainage: PACIFIC OCEAN																
Table 2 - SUMMARY OF HABITAT TYPES AND MEASURED PARAMETERS																
Survey Dates: 10/28/96 to 10/30/96																
Confluence Location: QUAD: FORT BRAGG LEGAL DESCRIPTION:																
LATITUDE:39°22'37" LONGITUDE:123°48'55"																
HABITAT	UNITS	HABITAT	HABITAT	MEAN	TOTAL	TOTAL	MEAN	MEAN	MAXIMUM	MEAN	TOTAL	MEAN	TOTAL	MEAN	MEAN	MEAN
UNITS	FULLY	TYPE	OCCURRENCE	LENGTH	LENGTH	LENGTH	WIDTH	DEPTH	DEPTH	AREA	AREA	VOLUME	VOLUME	RESIDUAL	SHELTER	CANOPY
MEASURED				ft.	ft.	%	ft.	ft.	ft.	sq.ft.	sq.ft.	cu.ft.	cu.ft.	POOL	VOL	RATING
#			%											EST.	EST.	
100	11	LGR	30	18	1828	21	5	0.2	0.7	93	9270	21	2149	0	6	99
1	1	HGR	0	8	8	0	8	0.1	0.3	45	45	5	5	0	10	100
2	1	CAS	1	32	64	1	10	0.5	1.1	420	840	210	420	0	70	92
41	6	RUN	12	21	860	10	7	0.4	0.9	179	7357	60	2462	0	12	97
56	4	SRN	17	53	2959	34	6	0.4	0.7	158	8828	61	3440	0	63	99
3	1	TRP	1	57	170	2	6	1.0	2.6	366	1098	366	1098	183	10	100
84	12	MCP	25	23	1915	22	8	0.8	2.7	162	13645	141	11858	113	40	98
4	2	LSL	1	20	81	1	10	1.1	2.3	212	848	224	898	171	38	100
5	2	LSR	2	21	105	1	7	1.0	2.1	136	680	173	866	157	40	100
2	1	LSBk	1	26	51	1	8	0.7	1.9	224	448	157	314	134	5	100
23	3	PLP	7	14	331	4	6	0.8	2.3	91	2101	76	1746	63	35	98
6	2	BPL	2	18	108	1	8	0.7	1.9	184	1104	143	859	102	48	98
5	0	DRY	2	15	74	1	0	0.0	0.0	0	0	0	0	0	0	0
1	0	CUL	0	38	38	0	0	0.0	0.0	0	0	0	0	0	0	0
TOTAL	TOTAL				LENGTH						AREA		TOTAL VOL.			
UNITS	UNITS				(ft.)						(sq.ft)		(cu.ft)			
333	46				8592						46264		26114			

CALIFORNIA SALMONID STREAM HABITAT RESTORATION MANUAL

Table J-3. Summary of pool types.

JUGHANDLE CREEK

Drainage: PACIFIC OCEAN

Table 3 - SUMMARY OF POOL TYPES

Survey Dates: 10/28/96 to 10/30/96

Confluence Location: QUAD: FORT BRAGG LEGAL DESCRIPTION:

LATITUDE:39°22'37" LONGITUDE:123°48'55"

HABITAT UNITS	UNITS FULLY MEASURED	HABITAT TYPE	HABITAT PERCENT OCCURRENCE	MEAN LENGTH (ft.)	TOTAL LENGTH (ft.)	PERCENT TOTAL LENGTH	MEAN WIDTH (ft.)	MEAN DEPTH (ft.)	MEAN AREA (sq.ft.)	TOTAL AREA (sq.ft.)	MEAN VOLUME (cu.ft.)	TOTAL VOLUME (cu.ft.)	MEAN RESIDUAL POOL VOL. (cu.ft.)	MEAN SHELTER RATING
87	13	MAIN	69	24	2085	76	7.8	0.9	178	15495	158	13786	118	37
34	8	SCOUR	27	17	568	21	7.5	0.9	149	5075	147	5014	122	33
6	2	BACKWATER	5	18	108	4	8.0	0.7	184	1104	143	859	102	48
TOTAL UNITS	TOTAL UNITS				TOTAL LENGTH (ft.)				TOTAL AREA (sq.ft.)			TOTAL VOL. (cu.ft.)		
127	23				2761				21673			19660		

CALIFORNIA SALMONID STREAM HABITAT RESTORATION MANUAL

Table J-4. Summary of maximum pool depths by pool habitat types.

JUGHANDLE CREEK		Drainage: PACIFIC OCEAN											
Table 4 - SUMMARY OF MAXIMUM POOL DEPTHS BY POOL HABITAT TYPES		Survey Dates: 10/28/96 to 10/30/96											
Confluence Location: QUAD: FORT BRAGG LEGAL DESCRIPTION:		LATITUDE:39°22'37" LONGITUDE:123°48'55"											
UNITS MEASURED	HABITAT TYPE	HABITAT PERCENT OCCURRENCE	<1 FOOT MAXIMUM	<1 FOOT PERCENT OCCURRENCE	1-<2 FT. MAXIMUM	1-<2 FOOT PERCENT OCCURRENCE	2-<3 FT. MAXIMUM	2-<3 FOOT PERCENT OCCURRENCE	3-<4 FT. MAXIMUM	3-<4 FOOT PERCENT OCCURRENCE	>=4 FEET MAXIMUM	>=4 FEET PERCENT OCCURRENCE	
			DEPTH	DEPTH	DEPTH	DEPTH	DEPTH	DEPTH	DEPTH	DEPTH	DEPTH	DEPTH	
3	TRP	2	0	0	1	33	2	67	0	0	0	0	
84	MCP	66	4	5	61	73	16	19	3	4	0	0	
4	LSL	3	0	0	2	50	2	50	0	0	0	0	
5	LSR	4	3	60	1	20	1	20	0	0	0	0	
2	LSBk	2	0	0	2	100	0	0	0	0	0	0	
23	PLP	18	0	0	14	61	8	35	0	0	1	4	
6	BPL	5	0	0	5	83	1	17	0	0	0	0	
TOTAL UNITS													
												127	

CALIFORNIA SALMONID STREAM HABITAT RESTORATION MANUAL

Table J-5. Summary of mean percent cover by habitat type.

JUGHANDLE CREEK

Drainage: PACIFIC OCEAN

Table 5 - SUMMARY OF MEAN PERCENT COVER BY HABITAT TYPE

Survey Dates: 10/28/96 to 10/30/96

Confluence Location: QUAD: FORT BRAGG LEGAL DESCRIPTION:

LATITUDE: 39°22'37" LONGITUDE: 123°48'55"

UNITS MEASURED	UNITS FULLY MEASURED	HABITAT TYPE	MEAN % UNDERCUT BANKS	MEAN % SWD	MEAN % LWD	MEAN % ROOT MASS	MEAN % TERR. VEGETATION	MEAN % AQUATIC VEGETATION	MEAN % WHITE WATER	MEAN % BOULDERS	MEAN % BEDROCK LEDGES
100	8	LGR	0	69	0	0	9	0	0	23	0
1	1	HGR	0	0	0	0	0	0	0	100	0
2	1	CAS	0	0	10	0	0	0	0	90	0
41	4	RUN	15	25	30	0	13	0	0	18	0
56	4	SRN	25	13	38	0	0	0	0	25	0
3	1	TRP	30	70	0	0	0	0	0	0	0
84	12	MCP	3	28	54	3	0	0	1	11	0
4	2	LSL	0	15	85	0	0	0	0	0	0
5	2	LSR	30	25	45	0	0	0	0	0	0
2	1	LSBk	0	100	0	0	0	0	0	0	0
23	3	PLP	13	0	23	17	0	0	3	43	0
6	2	BPL	25	40	35	0	0	0	0	0	0
5	0	DRY	0	0	0	0	0	0	0	0	0
1	0	CUL	0	0	0	0	0	0	0	0	0

CALIFORNIA SALMONID STREAM HABITAT RESTORATION MANUAL

Table J-6. Summary of dominant substrate by habitat type.

JUGHANDLE CREEK

Drainage: PACIFIC OCEAN

Table 6 - SUMMARY OF DOMINANT SUBSTRATES BY HABITAT TYPE

Survey Dates: 10/28/96 to 10/30/96

Confluence Location: QUAD: FORT BRAGG LEGAL DESCRIPTION:

LATITUDE:39°22'37" LONGITUDE:123°48'55"

TOTAL HABITAT UNITS	UNITS FULLY MEASURED	HABITAT TYPE	% TOTAL SILT/CLAY DOMINANT	% TOTAL SAND DOMINANT	% TOTAL GRAVEL DOMINANT	% TOTAL SM COBBLE DOMINANT	% TOTAL LG COBBLE DOMINANT	% TOTAL BOULDER DOMINANT	% TOTAL BEDROCK DOMINANT
100	11	LGR	0	0	82	18	0	0	0
1	1	HGR	0	0	0	100	0	0	0
2	1	CAS	0	0	0	0	0	100	0
41	5	RUN	0	20	80	0	0	0	0
56	4	SRN	0	25	75	0	0	0	0
3	1	TRP	0	0	100	0	0	0	0
84	12	MCP	25	33	42	0	0	0	0
4	2	LSL	0	50	50	0	0	0	0
5	2	LSR	0	50	50	0	0	0	0
2	1	LSEk	0	0	100	0	0	0	0
23	3	PLP	33	67	0	0	0	0	0
6	2	BPL	0	0	100	0	0	0	0
5	0	DRY	0	0	0	0	0	0	0
1	0	CUL	0	0	0	0	0	0	0

CALIFORNIA SALMONID STREAM HABITAT RESTORATION MANUAL

Table J-7. Fish habitat inventory data summary.

STREAM NAME: JUGHANDLE CREEK
SAMPLE DATES: 10/28/96 to 10/30/96
STREAM LENGTH: 8327 ft.
LOCATION OF STREAM MOUTH:
 USGS Quad Map: FORT BRAGG Latitude: 39°22'37"
 Legal Description: Longitude: 123°48'55"

SUMMARY OF FISH HABITAT ELEMENTS BY STREAM REACH

STREAM REACH 1

Channel Type: F4	Canopy Density: 98%
Channel Length: 8028 ft.	Coniferous Component: 38%
Riffle/flatwater Mean Width: 6 ft.	Deciduous Component: 62%
Total Pool Mean Depth: 0.8 ft.	Pools by Stream Length: 33%
Base Flow: 0.4 cfs	Pools >=3 ft.deep: 3%
Water: 048- 050°F Air: 042-056°F	Mean Pool Shelter Rtn: 38
Dom. Bank Veg.: Brush	Dom. Shelter: Large Woody Debris
Vegetative Cover: 96%	Occurrence of LOD: 36%
Dom. Bank Substrate: Cobble/Gravel	Dry Channel: 26 ft.

Embeddness Value: 1. 5% 2. 20% 3. 23% 4. 25% 5. 27%

STREAM REACH 2

Channel Type: A4	Canopy Density: 98%
Channel Length: 299 ft.	Coniferous Component: 10%
Riffle/flatwater Mean Width: 9 ft.	Deciduous Component: 90%
Total Pool Mean Depth: 1.0 ft.	Pools by Stream Length: 24%
Base Flow: 0.4 cfs	Pools >=3 ft.deep: 0%
Water: 049- 049°F Air: 049-049°F	Mean Pool Shelter Rtn: 27
Dom. Bank Veg.: Brush	Dom. Shelter: Boulders
Vegetative Cover: 94%	Occurrence of LOD: 8%
Dom. Bank Substrate: Cobble/Gravel	Dry Channel: 48 ft.

Embeddness Value: 1. 0% 2. 50% 3. 17% 4. 0% 5. 33%

JUGHANDLE CREEK

HABITAT TYPES BY PERCENT OCCURRENCE

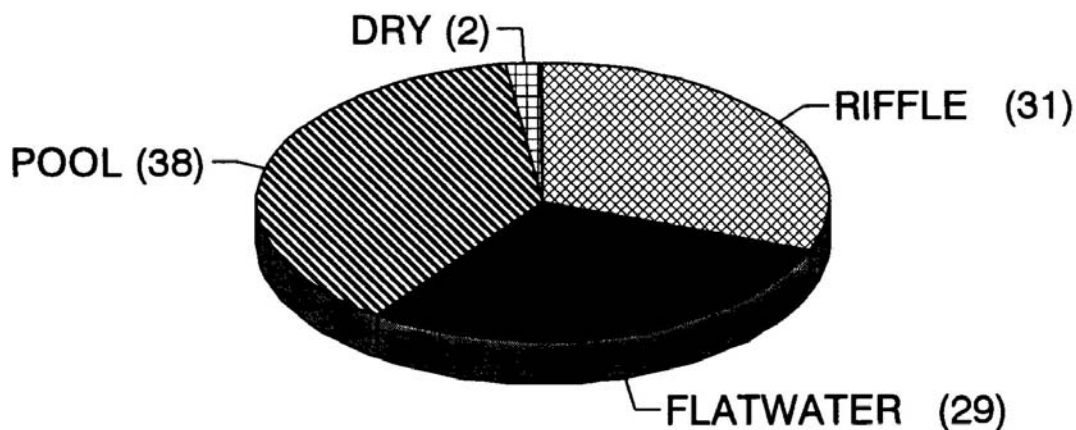

Graph J-1. Habitat types by percent occurrence.

JUGHANDLE CREEK

HABITAT TYPES BY PERCENT TOTAL LENGTH

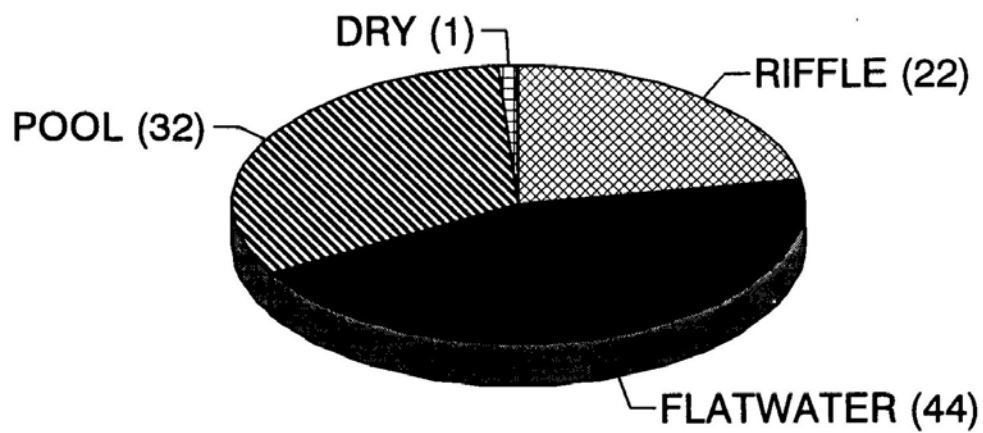

Graph J-2. Habitat types by percent total length.

JUGHANDLE CREEK HABITAT TYPES BY PERCENT OCCURRENCE

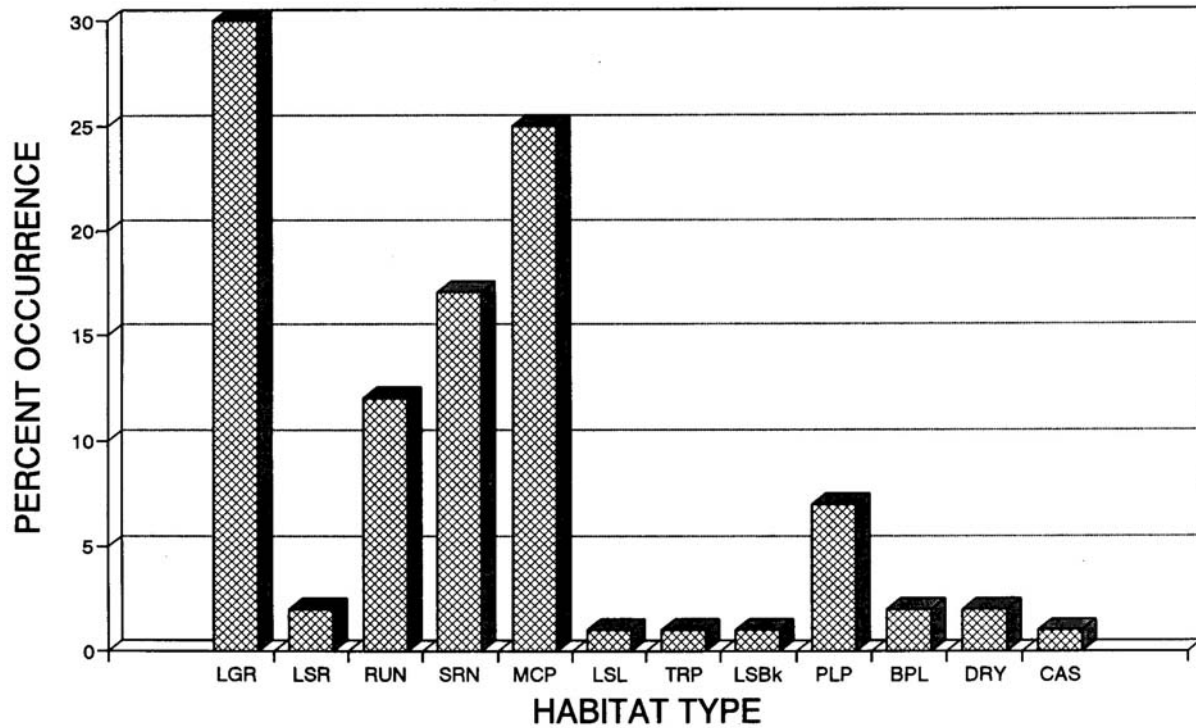

Graph J-3. Habitat types by percent occurrence.

JUGHANDLE CREEK

POOL HABITAT TYPES BY PERCENT OCCURRENCE

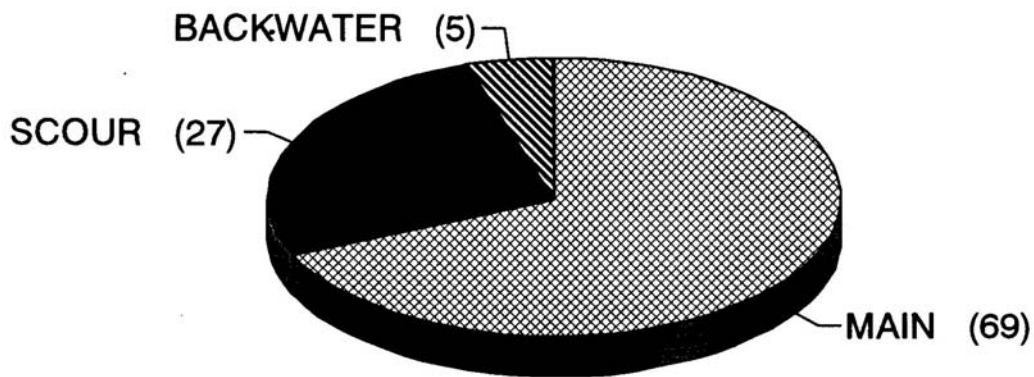

Graph J-4. Pool habitat types by percent occurrence.

JUGHANDLE CREEK MAXIMUM POOL DEPTHS

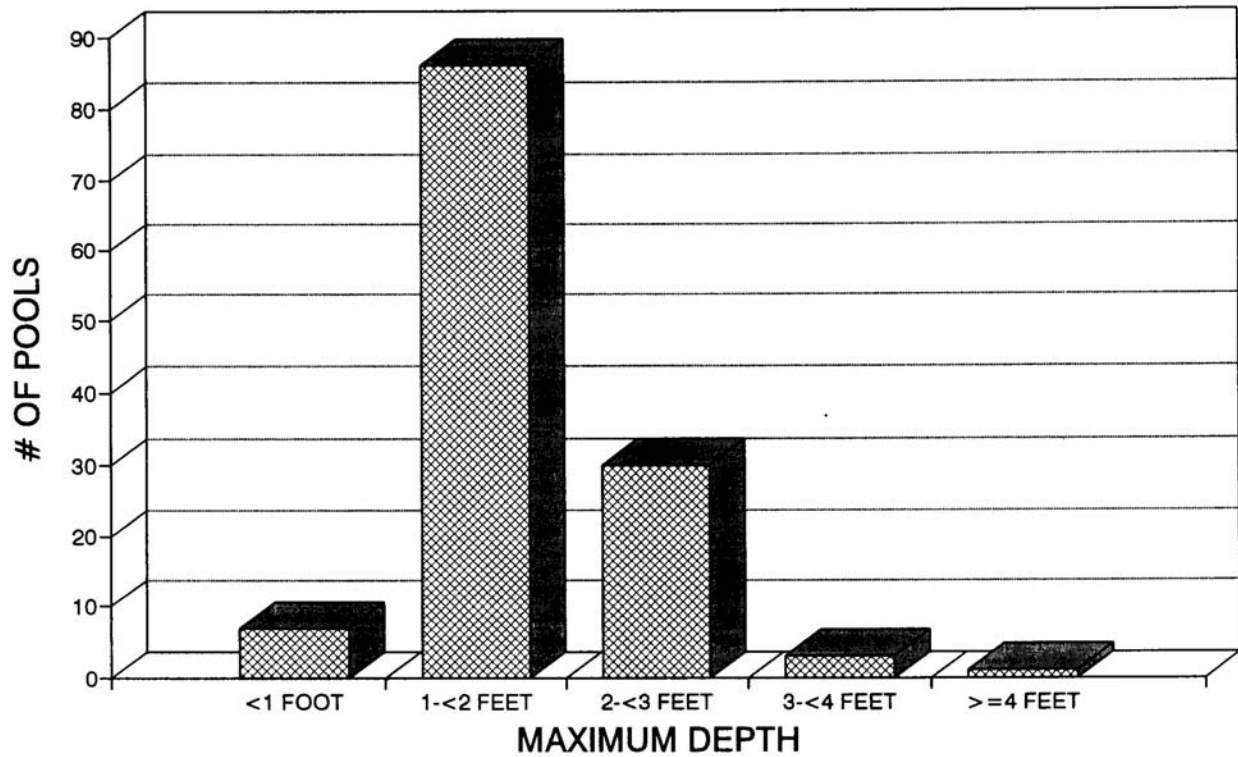

Graph J-5. Maximum pool depths.

JUGHANDLE CREEK PERCENT EMBEDDEDNESS

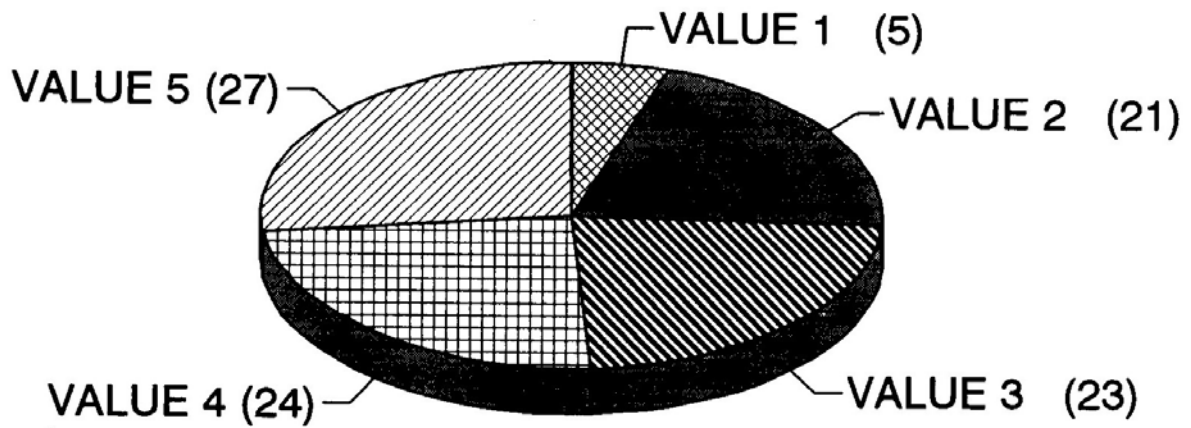

Graph J-6. Percent embeddedness.

JUGHANDLE CREEK

MEAN PERCENT COVER TYPES IN POOLS

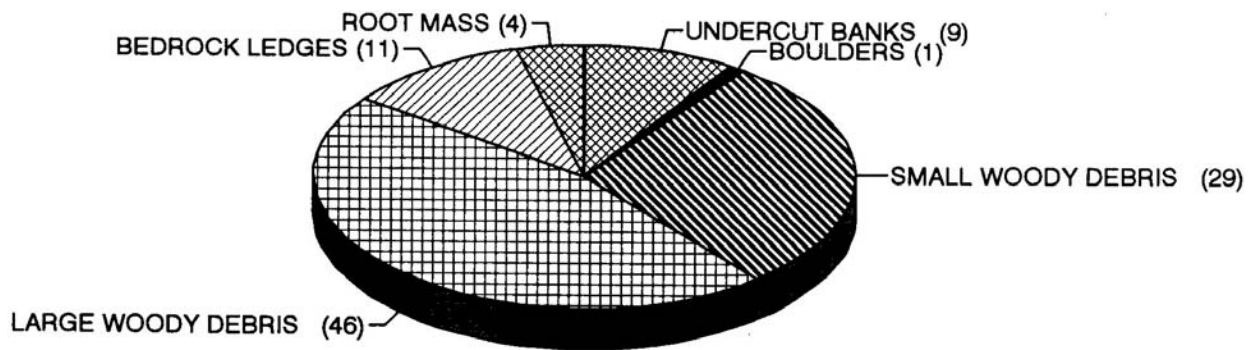

Graph J-7. Mean percent cover types in pools.

JUGHANDLE CREEK SUBSTRATE COMPOSITION IN LOW GRADIENT RIFFLE

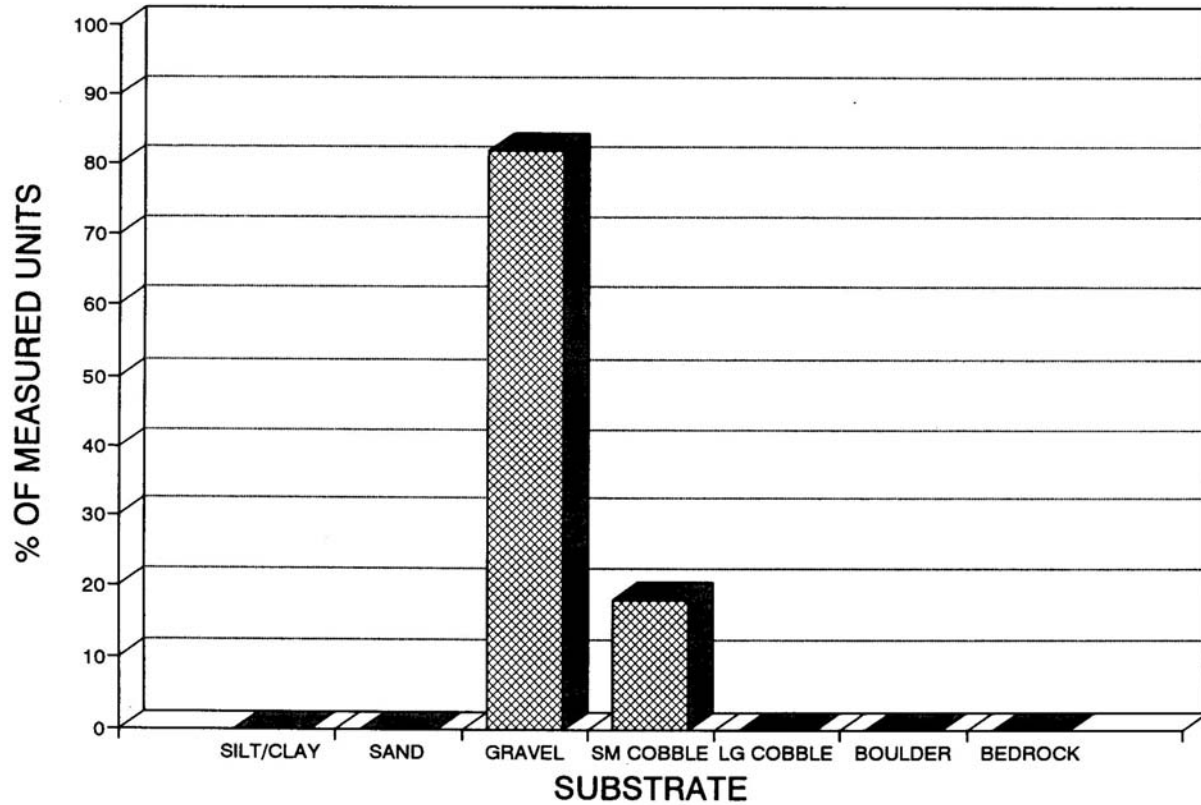

Graph J-8. Substrate composition in low gradient riffles.

JUGHANDLE CREEK

PERCENT CANOPY

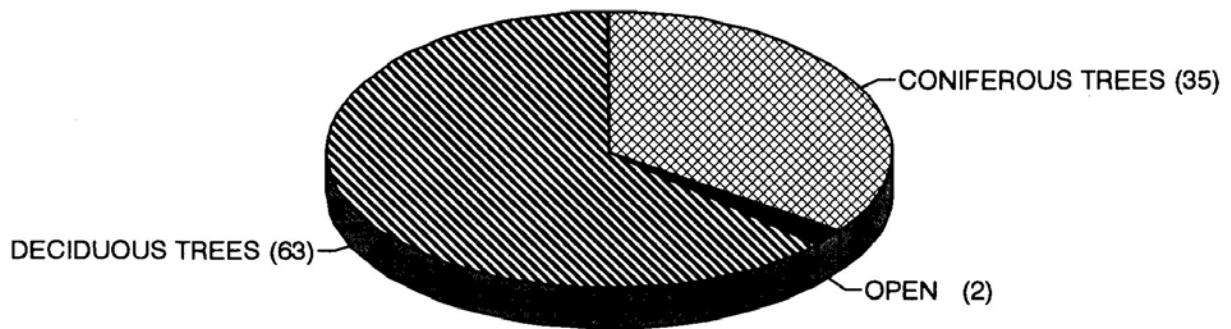

Graph J-9. Percent canopy.

JUGHANDLE CREEK

DOMINANT BANK COMPOSITION IN SURVEY REACH

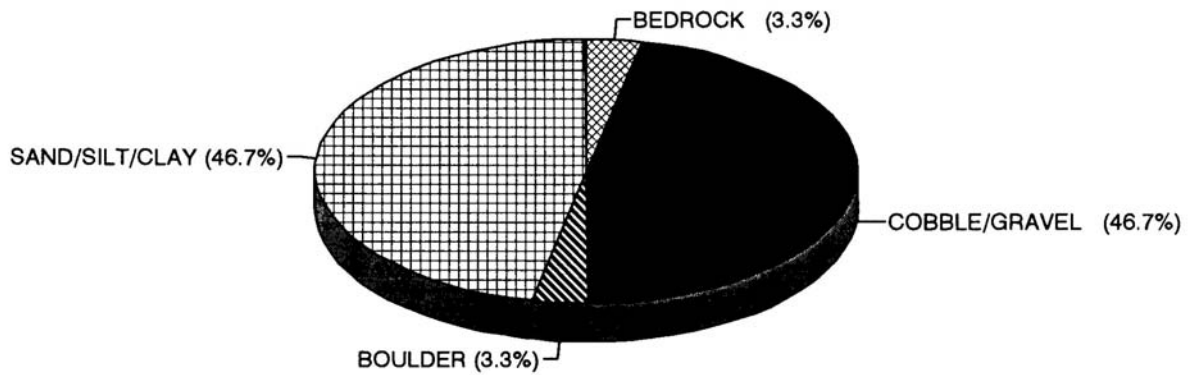

Graph J-10. Dominant bank composition in survey reach.

JUGHANDLE CREEK

DOMINANT BANK VEGETATION IN SURVEY REACH

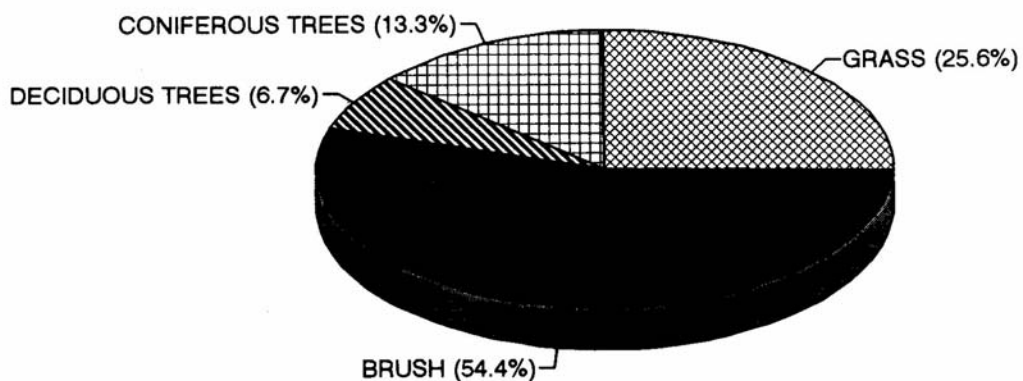

Graph J-11. Dominant bank vegetation in survey reach.

CALIFORNIA SALMONID STREAM HABITAT RESTORATION MANUAL

APPENDIX K.

TOOLS

Following is a check list of the most commonly used tools for stream enhancement/restoration projects. The tools needed will depend on the specific project. Before traveling to the work site a check of the tools must be done to insure that everything is available when needed.

Hand tools include:

- shovels
- rock bars
- sledge hammers
- splitting mauls
- picks
- pulaski's
- peeves
- pliers
- wire cutters
- tape measures
- files for the tools
- fence post/rebar driver
- cable cutter (guillotine type)
- log carriers

Power tools include:

- chain saws including:
 - extra chain
 - extra bars
 - plastic wedges
 - file guide with file
 - chain depth gauge
 - raker file
 - extra spark plugs
 - extra air filter
 - tool for adjusting chain and bar
 - grease gun for roller nose or sprocket nose bar
 - can spray degreaser
 - can for mixed gas and bar oil
 - auto parts brush
 - rags
 - fire extinguisher
 - single bit axe

CALIFORNIA SALMONID STREAM HABITAT RESTORATION MANUAL

various spare parts (bar nuts, gas filters, etc.)
backpack for carrying equipment and supplies

chain saw winch

skill saw with metal cutting blade

gas powered drills: These come in a variety of sizes for various applications.

The largest gas powered drills are used to drill rock for chipping and blasting. Smaller gas powered drills are available to drill rock. Some gas powered drills are only used to drill wood. Each has its place and function. Correct selection depends on the needs of the project.

electric rotary hammer with carbide tipped rock drills:

gas powered generator
heavy duty outdoor extension cord
ground fault interrupter

electric drill with drill bits (wood augers)

Griphoist including:

tool box containing:

handle puller
spare shear pins
claw hammer
crescent wrench
socket set (standard and metric)
screwdriver set
allen wrenches
hack saw with extra blades

snatch blocks (two per griphoist)

shackles (to attach cable straps or chains together)

chokers (three per griphoist)

chain (12 ft. minimum to anchor the griphoist)

cable straps (various sizes from 10 to 100 feet long)

extra mainline

rock nets (these can be made from chain or bought pre-made)

cable gripper

CALIFORNIA SALMONID STREAM HABITAT RESTORATION MANUAL

Safety equipment including:

first aid kit
hard hats
earplugs
gloves
boots
eye and face protection
chaps for use with chain saws

Shuttling equipment

backpacks
wheelbarrows
hand carried stretchers
all terrain vehicles with trailer

CALIFORNIA SALMONID STREAM HABITAT RESTORATION MANUAL

APPENDIX L.

TWO-PIN METHOD

Procedure

The two-pin method is useful to locate natural and human influenced features within a project site relative to two permanent reference points (Miller, O'Brien, Koonce, 1988). It can be used to describe and map existing geomorphic channel conditions of a proposed restoration site. It is useful during restoration project design, layout, and construction phases, and during subsequent project phases of monitoring and evaluation.

The two-pin method is based on establishing a reference pin at the upstream and downstream ends of a given enhancement site. These pins are placed on one side of the stream, with each pin located further upstream and downstream than the extent of the enhancement structure. By convention, Pin 1 is downstream of Pin 2.

Enhancement sites along the channel are referenced according to a curvilinear traverse line along one side of the stream. For example, Site 12+50 is equivalent to a distance of 1,250 feet upstream from an assigned starting point. By convention, references begin at the downstream end of an enhancement section and progress upstream. Generally, the traverse line simply follows the course of the stream. Bearings and azimuths are not recorded for meander curvature. Specific locations on the traverse line could be referenced to a nearby stadia or route survey (i.e., a road centerline) by recording distance and bearings from specific points along such surveys.

All the important channel features are located using triangulation of intersecting horizontal distances from the reference pins. Once the pins are in place, a tape measure is stretched from each pin. The intersection of the two tapes defines a measuring point (Figure L-1). A scale map is drawn for each site showing large woody debris, instream boulders, etc. (Figure L-2).

Each enhancement structure is laid out on the ground using wire flags so that the structures can be triangulated and accurately mapped. The triangulation distances are recorded in a standardized table (Table L-1). The design elevations for the top of the log or boulder ends are also measured from the reference pins. By convention the elevation of pin 1 is recorded as 0 (Table L-1).

CALIFORNIA SALMONID STREAM HABITAT RESTORATION MANUAL

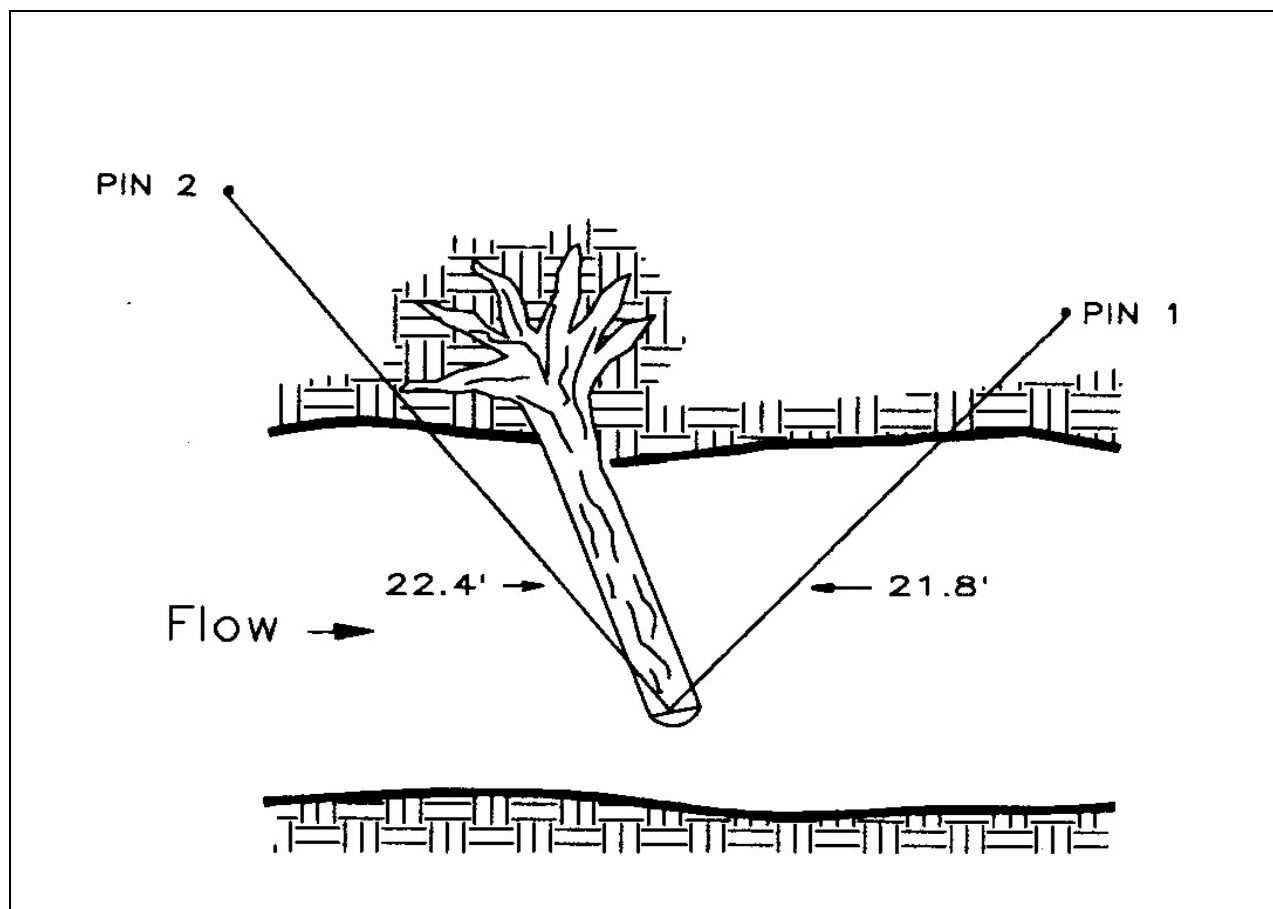

Figure L-1. Location of the left bank end of a downed tree as determined by the intersection of the distances from two reference pins (Miller, O'Brien, Koonce, 1988).

Table L-1. Measured distances and elevations of existing and prescribed structural components relative to the two reference pins at station 171+20 along Tarup Creek, Del Norte County, California. Existing features are described by numbers: prescribed features by letters: all corresponding with those in Figure 2. (Adapted from Inter-Fluve, 1987)

Item	Distance(ft)		Elevation(ft) ^{a/}	
	Pin 1	Pin 2	Pin 1	Pin 2
Pin 1	57		-0.4	
Pin 2	57		+0.4	
Log 1,	19	57		
Log 2,	37	41		
Log 3,	47	34		
Log 4,	50	20		
Boulder 5,	36	51		
Boulder 6,	31	48		
Log A,	49	16	-3.5	-3.9
Log A,	30	44	-4.9	-5.3
Log B,	41	67		
Log B,	29	56	-5.4	-5.8
Log C,	33	65		
Log C,	31	58	-5.7	-6.1
Boulder D,	28	45	-4.9	-5.3
Boulders E,	10	54		

^{a/} Elevation from pin: + above; - below

CALIFORNIA SALMONID STREAM
HABITAT RESTORATION MANUAL

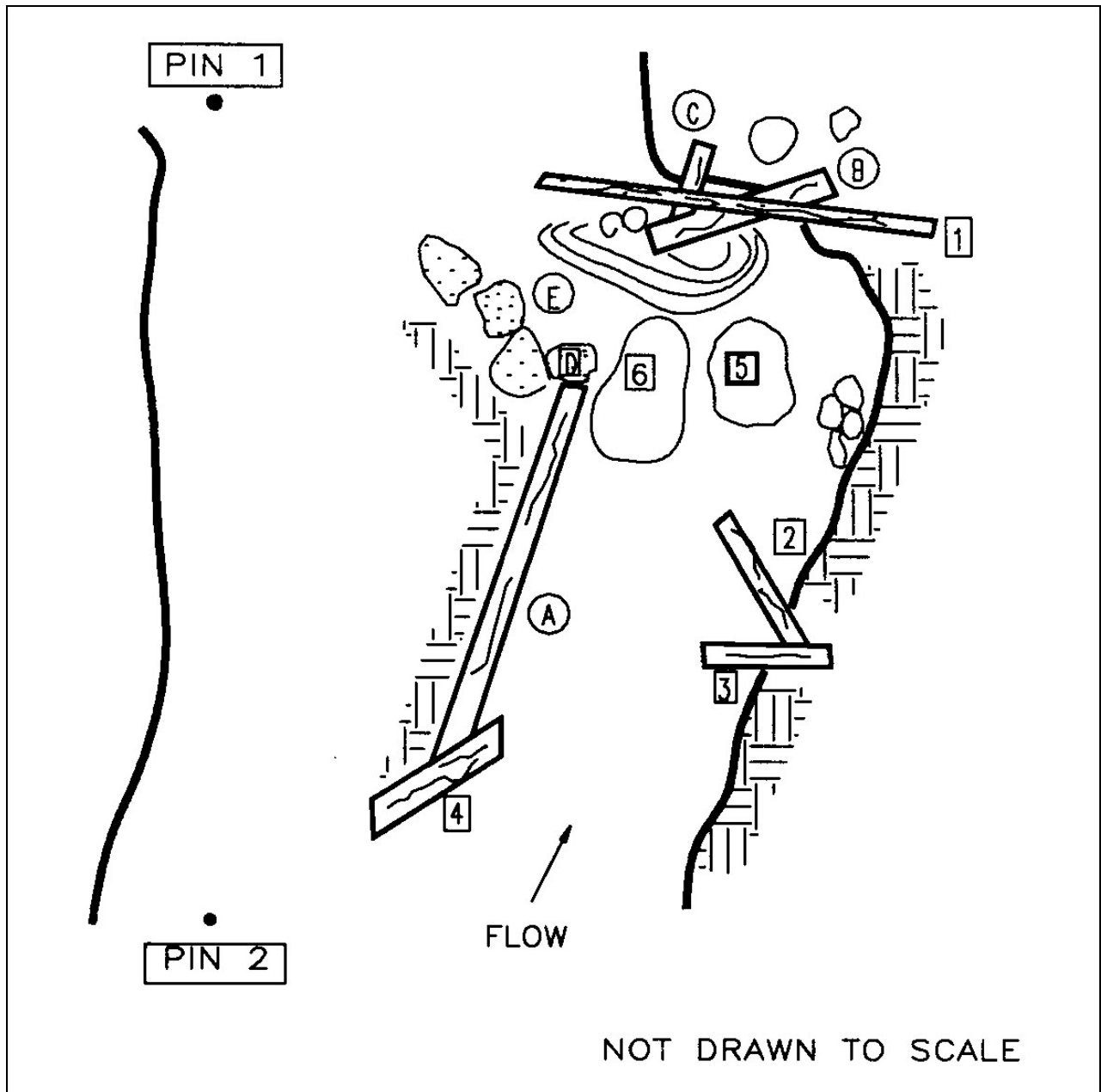

Figure L-2. Typical to-scale plan schematic depicting existing (numbered) and prescribed (lettered) features relative to reference pins. Features correspond with those in Table L-1 (Miller, O'Brien, Koonce, 1988).

At each site notes should be taken describing the condition of the channel. For each enhancement structure the anticipated results of the project are noted. Materials available on site are also recorded. A table of materials and availability is developed (Table L-2). This information helps the construction crew conceptualize what has been designed.

CALIFORNIA SALMONID STREAM HABITAT RESTORATION MANUAL

Table L-2. Materials, with estimated dimensions and quantities, required for a station 171+20 along Tarup Creek, Del Norte County, California. The sources for individual items are indicated as available on-site, near to the site or through a specified supplier. Lettered items correspond with those in Figure L-2.

Material	Size		Quantity	Source
	Diameter	Length		
Log A, redwood	2 ft.	32 ft.	1	onsite
Log B, redwood	1.5 ft.	14 ft.	1	nearsite
Log C, redwood	1.5 ft.	7 ft.	1	nearsite
Galvanized cable	3/8 in.	35 ft.	1	supplier
Galvanized cable	1/2 in.	20 ft.	1	supplier
Cable clamps	3/8 in.		4	supplier
Cable clamps	1/2 in.	4		supplier
Rock	2 ft.			near & offsite
Willow cuttings	1/2 in.	2 ft.	100	near & offsite

Construction

Following the enhancement designs during construction involves the simple reversal of the scaled plan map and dimension table preparation process. Fiberglass tapes are stretched from each reference pin to the distances noted in the structure location table. The intersection designates a structural feature, such as the bank end of a log or the center of a boulder. Temporary wire-flags are placed at each intersection point until all important features are delineated. In this way, the location and orientation of a log weir can be identified, and the log can be related to other elements of the design. Once the scaled plan map is verified, construction can begin. The amount of excavation or fill for prescribed features is determined by measuring the appropriate depths using a hand-held Abney level, a tripod-based builders level, or in simple cases, a string level.

Inherent Error In The Methodology. Under ideal conditions, the two-pin method allows little room for error between design intention and construction implementation. Aside from simple misinterpretation, any errors are the result of limits in the measurement system. Elevations can be established to a level of accuracy by extending measurement precision to a higher level of magnitude. For example, if 0.5 foot is an acceptable margin of error, measurements should be recorded in the structure location table to within 0.1 foot.

The plan location of enhancement features is based on intersecting distances from two fixed points. The intersection of two non-parallel lines defines only one position. The two-pin method is similar to that used in maritime navigation, where a "fix" is determined by the intersection of two distance circles. Error can arise in prescribed feature locations due to the inherent short-comings of the triangulation method. Because measurements occur twice, once for design and once for construction, errors can be compounded.

CALIFORNIA SALMONID STREAM HABITAT RESTORATION MANUAL

While measuring from reference pins using the two-pin method, a small intersecting angle would occur in two scenarios: 1) when a measured position is quite far from the reference points (Figure L-3); and 2) when a position does not fall roughly between the reference points (Figure L-4).

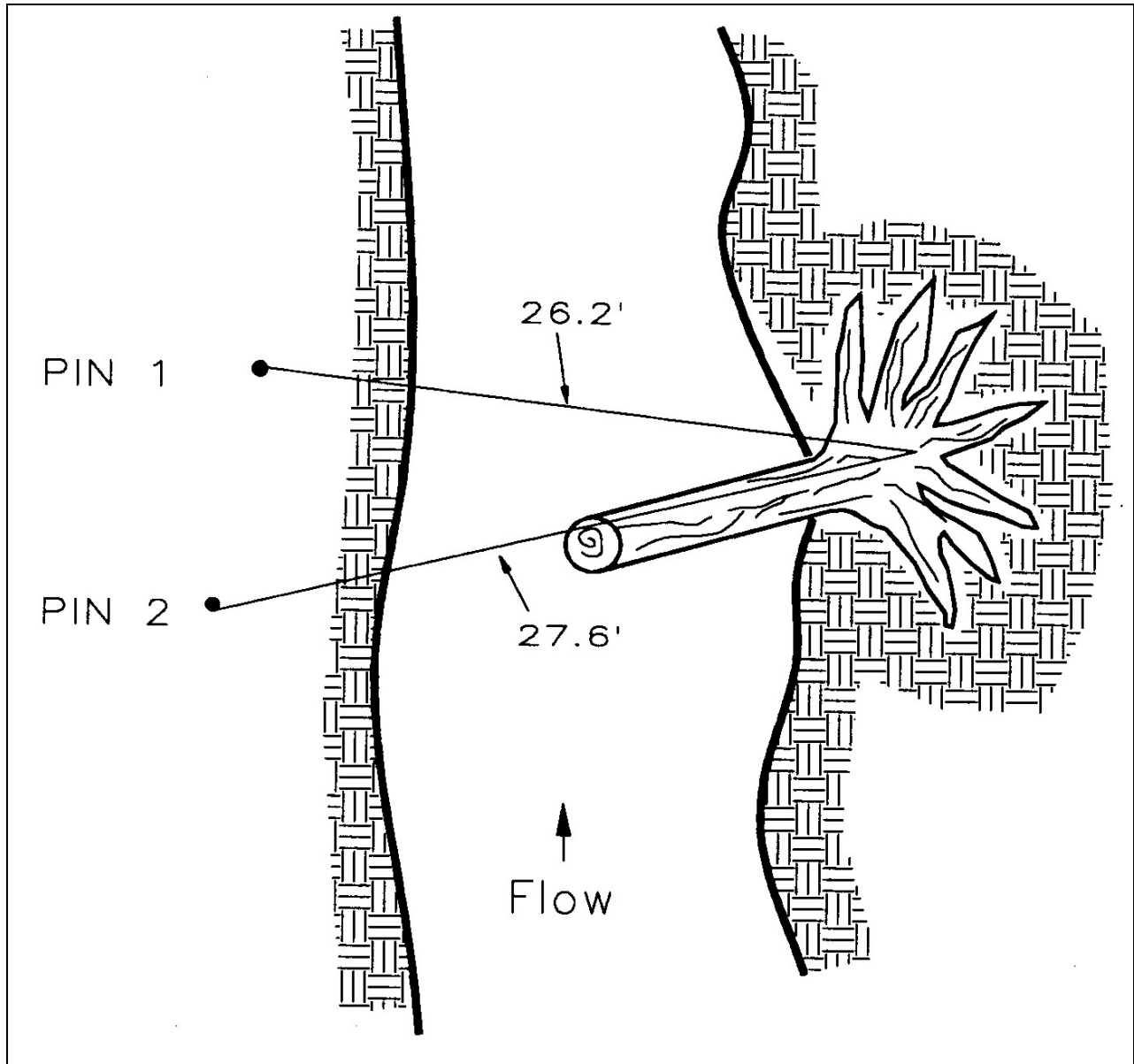

Figure L-3. Measured position quite far from reference pins results in an acute angle with a high potential for measurement error (Miller, O'Brien, Koonce, 1988).

CALIFORNIA SALMONID STREAM HABITAT RESTORATION MANUAL

Two important guidelines should be followed to reduce the amount of fix error:

- 1) Reference pins should always be placed upstream and downstream from the furthest extent of the prescribed enhancement structure. In this way, position lines from the downstream pin never extend downstream and those from the upstream pin never extend upstream (Figure L-4). More than 2 pins may be utilized on very large scale sites, or those sites occurring on tight radius bends.

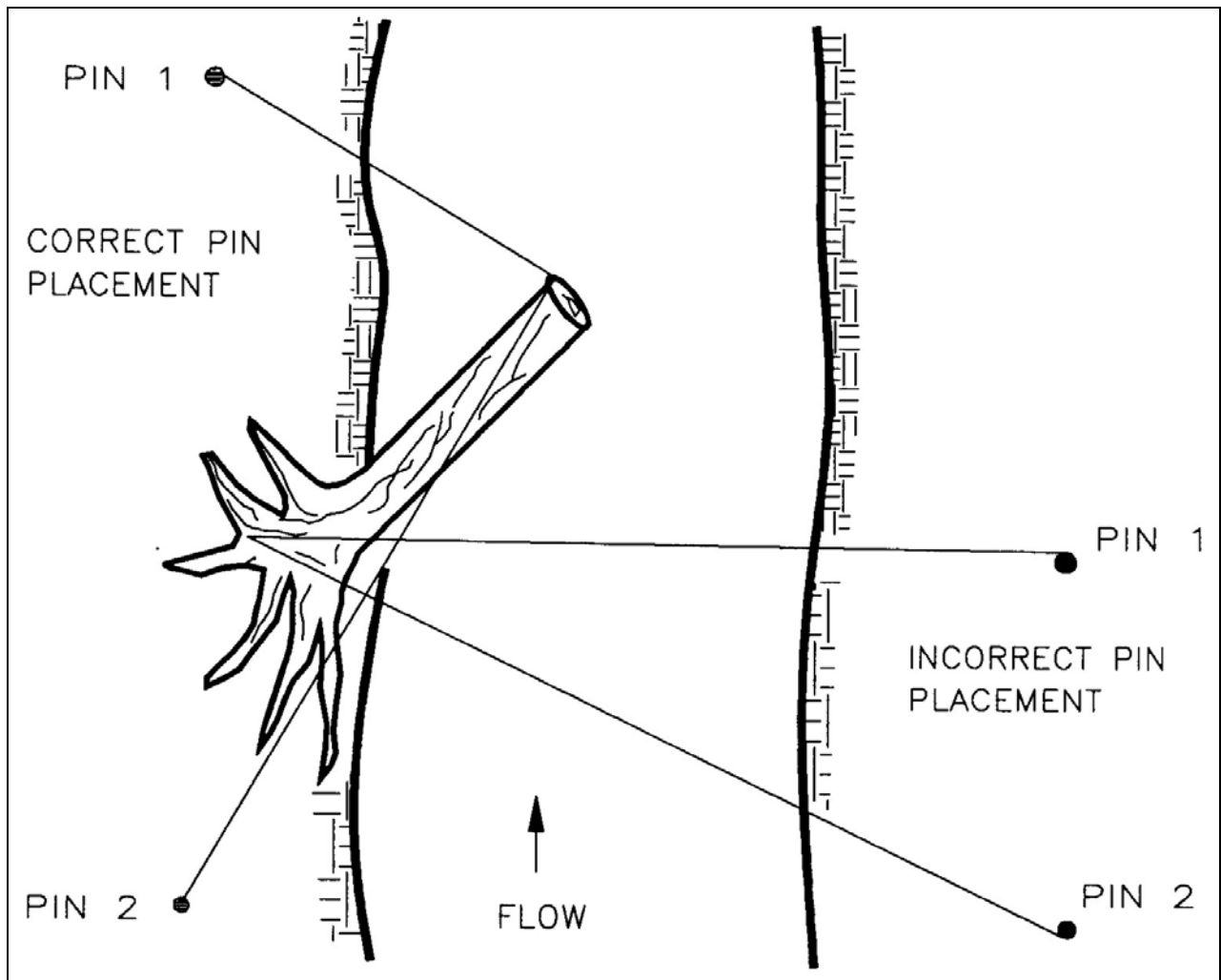

Figure L-4. Reference pins should be placed well upstream and downstream of the area to be measured. In this way, the intersecting angle approaches 90 degrees (Miller, O'Brien, Koonce, 1988).

- 2) Reference pins should be placed so that the longest measurement across the channel does not exceed $1/2$ of the distance between pins. Usually, acceptable results are given if the pins are located so the distance between them is slightly more than twice the channel width (Figure L-5).

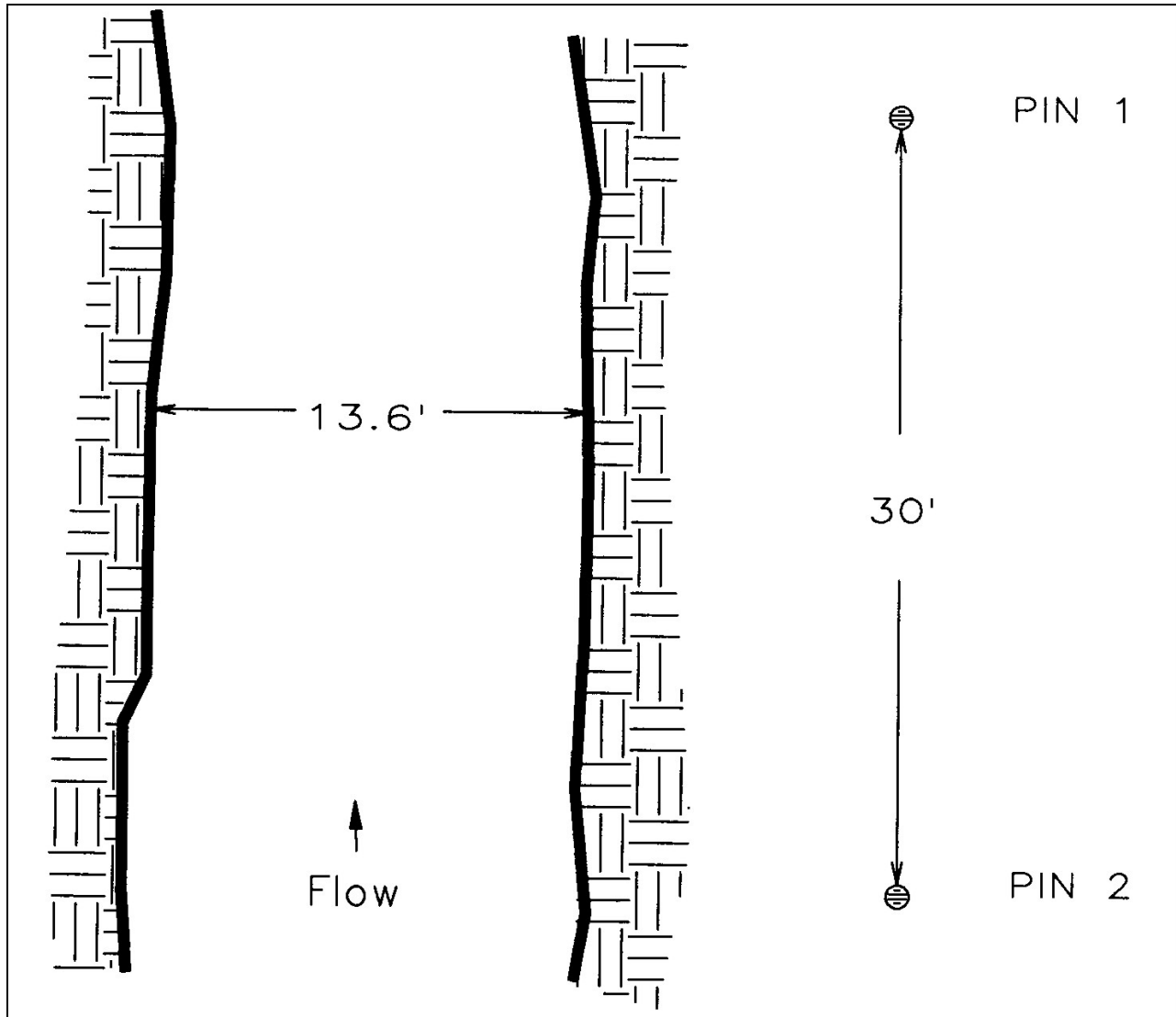

Figure L-5. Proper spacing of reference pins is slightly greater than twice the channel length (Miller, O'Brien, Koonce, 1988).

Management Implications

Stability Analysis. The two-pin method is a relatively precise, inexpensive means to evaluate the long-term stability of enhancement structures. Post-construction documentation of selected locations of structural components can be compared with measurements following annual high flow periods or even specific runoff events. For example, the plan and profile location of a group of boulders in an instream cluster can be documented by measuring the fix and elevation at the center of each boulder. With such records, any movement of the boulders following runoff events can be readily qualified.

CALIFORNIA SALMONID STREAM HABITAT RESTORATION MANUAL

Habitat and Bedform Mapping. Where sampling occurs over a short area, a plan schematic can be developed using the two-pin method to depict the location of different parameter measurement sites. For example, the location of benthic invertebrate, substrate and water quality sampling sites can be illustrated on a plan map. General geomorphic maps of bedforms such as pools, riffles and bars of stream channels can be developed utilizing the two-pin method.

Contract Specifications. Managers involved with the setup and coordination of instream habitat construction who prepare typical engineering-style blueprint design documents may find the two-pin method more cost efficient and easily implemented by work crews. Similarly, projects which stipulate background biological sampling may use the two-pin method to identify specific sample sites for contractors. In some cases, design details or sampling areas identified with this methodology could result in more specific proposals from bidders, thereby allowing more accurate comparison of contract line items.

Location maps for each project reach, which show the stream section and any roads or trails associated with it, are versatile tools. They can be constructed by tracing on mylar or acetate the area and features necessary from a map or an aerial photograph. Photocopies are then taken of the transparency and can be reduced or enlarged as needed for field maps. During the field layout, all on site construction materials and access routes for work crews, equipment, and materials should be located on these maps and thoroughly described.

Photographic documentation of the project site, using established photo points, is desirable during the layout phase (Part VIII). It is the most cost-effective means of recording site conditions at any particular time and should be used frequently throughout a project's lifetime. Photographs taken during pre-project phases can be taken out in the field in clear plastic protective cases and used to help compare views and align new photographs.

The actual project site layout is the transition between the planning phase and the construction phase and is a critically important stage for any project. If adequate time is used to set it up right in the field, using all the tools available to you, the actual construction phase will run smoothly and cost-effectively. Thorough documentation is strongly recommended using field notebooks, site location maps, stream reach maps, cross section diagrams, and photographs. It is recommended to establish photo points, using the two-pin method if necessary, to document the progress and effects of the project. Photo documentation is best when aspect, light, camera, and lens selection is consistent.

CALIFORNIA SALMONID STREAM HABITAT RESTORATION MANUAL

REFERENCES

- Koonce, Gregory P. 1990. Two-Pin Method for the Layout of Stream Habitat Enhancement Designs. Proceedings of the Eighth Annual California Salmon, Steelhead and Trout Restoration Conference. Eureka, California, USA.
- Miller, Dale E., R. J. O'Brien, and G. P. Koonce. 1988. Two-Pin Method for the Implementation of Instream Habitat Enhancement Designs. Presented at the 1988 Fisheries Bioengineering Symposium in Portland, Oregon, USA.

CALIFORNIA SALMONID STREAM HABITAT RESTORATION MANUAL

APPENDIX M.

SPECIALTY INSTRUMENTS

Geographic Information System (GIS)

The generally accepted definition of a GIS is an automated system that inputs, manages, manipulates, analyzes, and displays geographic data in digital form. Data in a GIS are spatially referenced, that is, defined by their location on the earth, and can be mapped. Each object is identified by a specific geographic location using latitude and longitude coordinates, described by single or multiple characteristics, and related to other features in the GIS. Therefore, three pieces of information are essential for each feature entered into a GIS database: where it is, what it is, and how it relates to other features (e.g., which streams link to form a river basin).

A GIS system has the capability of making maps and analyzing data within spatial parameters. For example, a GIS containing the appropriate data can produce a map of all restoration projects involving instream structures in tributaries to the South Fork Eel River. A similar, but more specific query of, "show only those projects in tributaries known to contain coho", would produce another map. Another query might ask to either list or display on a map all salmonid rearing projects within 50 miles of Fort Bragg.

Uses of spatial data within a GIS format provide resource managers, specialists, and planners a variety of analytical and monitoring tools. GIS capabilities include: 1) the geographic display of environmental, infrastructure, and social features, 2) display maps of geographic characteristics needed for analysis, 3) visually present changes of environmental or other features based on monitoring data, and 4) model alternative scenarios for management plans.

The GIS software presently in use by the California Department of Fish and Game is ARC/INFO.

The key component for entering data into the GIS system is location. Location is defined by latitude and longitude coordinates determined from USGS maps and a "Coordinator" tool, or a Global Positioning System (GPS) instrument.

Coordinator

The Coordinator is designed to enable the user to precisely determine the north latitude and west longitude of any point on all United States Geological Survey (USGS) and Canadian Department of Mines Topographic maps currently available and produced to the following scales: 1:20,000; 1:24,000; 1:25,000; 1:30,000; 1:50,000; 1:62,500; 1:63,600; 1:100,000 and 1:250,000.

CALIFORNIA SALMONID STREAM HABITAT RESTORATION MANUAL

The following steps are used to determine latitude and longitude of any point selected on USGS topographic maps.

Step 1. Carefully mark the point on the map for which the latitude and longitude is to be determined.

Step 2. Determine the scale to which the map has been produced. The scale referred to is printed in the white border area of every topographic map, generally either in the center of the lower border or, occasionally, in one of the four corners of the map. The most commonly used USGS topographic maps by DFG are the 7.5 minute quadrangle series at a 1:24,000 scale. The 15 minute series USGS topographic maps at a 1:62,500 scale are no longer produced but still exist in most offices. **BE CERTAIN YOU USE THE CORRECT SCALE FOR THE MAP YOU HAVE.**

Step 3. Select the scale on the Coordinator that corresponds to the map scale determined in Step 2. Each Coordinator scale designation appears on the extreme left of the Coordinator, at the base of and at right angle to the scale to which it pertains. (Note that 1:20,000 is shown as 1:20K, 1:24,000 as 1:24K, etc.)

Step 4. Observe that every topographic map has a beginning north latitude printed on the bottom left and right border of the map area and an ending north latitude printed on the top left and right border of the map area. The beginning west longitude of every map is printed on the top and bottom of the right map border and the ending west longitude is printed on the top and bottom of the left map border.

Step 5. Additionally, there are intermediate points every 2'30" between the beginning and ending north latitude and west longitude printed along the corresponding vertical and horizontal borders of the map area on 1:20K, 1:24K, 1:25K and 1:30K maps. Intermediate points are at 5'00" intervals on 1:50K, 1:62.5K and 1:63.6K maps and at 15'00" intervals on 1:100K and 1:250K maps.

Step 6. Furthermore, within the map area itself, note that where hypothetical lines that would connect corresponding intermediate latitude and longitude points would intersect, there exist + marks.

IN USING YOUR COORDINATOR, IT IS IMPORTANT TO REMEMBER THAT LONGITUDE ALWAYS INCREASES IN AN EAST TO WEST (from right to left) DIRECTION AND, IN THE NORTHERN HEMISPHERE, LATITUDE ALWAYS INCREASES IN A SOUTH TO NORTH (going up) DIRECTION.

Step 7. DETERMINING NORTH LATITUDE. Create a line across the map at the nearest intermediate points (Step 5) above and below the point you have marked in Step 1. These lines will hereafter be referred to as "framing lines." If your Step 1 point falls between the bottom edge of the map area and the first intermediate point, or between the top edge of the map area and the first intermediate point below, it is only necessary to create a single framing line as the map area edge will serve as the other framing line.

CALIFORNIA SALMONID STREAM HABITAT RESTORATION MANUAL

Step 8. Using the Coordinator scale selected in Step 3, lay the Coordinator on the map so that the scale begins on the framing line below your Step 1 point, and ends on the framing line above it AND that your Step 1 point falls on the Coordinator scale itself.

Step 9. Reading the Scale. Each scale on the Coordinator has two sets of incremental designations, the LEFT beginning at 30" and the RIGHT beginning at 00". It is essential in reading the scale, if your lower framing line is at 30", that you read from the left scale that begins at 30" and if the lower framing line is at 00", that you read from the right scale that begins at 00".

Having determined the correct incremental scale designation to use, note that as you read up the scale, each time you would reach the 00" point on the Coordinator scale, you must add 1' to the beginning north latitude at your lower framing line.

Step 10. DETERMINING WEST LONGITUDE. West longitude is determined in a generally similar manner as north latitude (i.e., by creating framing lines running north and south at the intermediate (Step 5) points on either side of your Step 1 point). Similar to determining north latitude, if your Step 1 point falls between either edge of the map area and the first intermediate point, only a single framing line need be created. Unlike the "imaginary" latitude lines which are ALWAYS equidistant and absolutely parallel between the equator and the north pole, LONGITUDE "LINES" are furthest apart at the equator and gradually converge to zero separation at the north pole. For this reason, the Coordinator must be positioned DIAGONALLY between your north-south Longitudinal framing lines.

Reading the Scale. The same scale on the Coordinator is used for determining BOTH north latitude and west longitude. MAKE CERTAIN that the Coordinator is positioned with the scale reading from right to left (east to west) as this is the direction in which longitude increases. Read the appropriate incremental scale designations as in Step 5, being careful to note whether your beginning intermediate longitude is at 30" or 00".

NOTE: Some Step 1 points near the edges of any topographic map dictate that one framing line be created past the edge of the map for computing west longitude ONLY, due to the diagonal positioning of the Coordinator required.

CALIFORNIA SALMONID STREAM HABITAT RESTORATION MANUAL

Global Positioning System (GPS)

GPS is a satellite-based positioning system operated by the U.S. Department of Defense (DOD). The system consists of 24 satellites orbiting the earth every 12 hours at an altitude of 12,600 nautical miles. Four satellites orbit in each of six different planes. Each satellite contains several high-precision atomic clocks and constantly transmits radio signals using its own unique identifying code.

When locating a position on earth, a GPS unit receives radio signals from "visible" satellites and computes the distance from each satellite to the receiver. The GPS computer uses triangulation to calculate a location point and displays this point in latitude and longitude. The satellites act as reference points for position fixes. Good quality fixes require signal reception from four satellites, a satellite constellation. Distance measurements from each satellite to the GPS receiver are performed within the receiver by timing how long it takes a radio signal to reach the GPS unit, and then calculating the distance based on time and the speed of radio waves (speed of light x time = distance). Most receivers measure time in nanoseconds, one-billionth of a second.

GPS accuracy depends on geometric position of satellites within a constellation, atmospheric conditions, and if DOD is introducing error into the system for national security purposes. Software is available to correct for DOD error. Uncorrected error can result in fix errors of ± 300 feet (100 meters); corrected positions are accurate to within 12 feet (2 meters) or less.

GPS can be used to obtain fixes for defining points, lines or areas. Locations of specific sites (e.g., bridges, stream confluences, project sites, problem areas) can be determined by collecting 150 to 200 points or fixes and averaging them to obtain a mean latitude and longitude. Most receivers record a fix every one to two seconds. Longer fix intervals can be selected. Stream courses can be tracked by walking along the stream channel and recording GPS fixes every one to five seconds. GPS points recorded while walking the perimeter of a lake will provide a perimeter line and surface area calculation of the lake. Fix data can be recorded within the GPS unit and later downloaded onto computer disks. Software enables averaging for point fixes, line drawing indicating points along a route (e.g., a stream course), area measurements, distances between points, and other measurements using data points. GPS data can be exported to a GIS system for further analysis.

GPS technology is rapidly being developed and improved. Early GPS units were three-channel receivers. Most GPS units produced today are five- to eight-channel receivers. More channels reduces satellite acquisition time and provides better signal "lock" in vegetative cover. Newer GPS units also have improved displays and are more user-friendly than earlier models.

CALIFORNIA SALMONID STREAM HABITAT RESTORATION MANUAL

The primary drawback to using GPS in streams is the difficulty in receiving and maintaining satellite signals under vegetation or stream canopy. GPS radio signals travel "line-of-sight" and do not penetrate solid objects well. Basically, if you cannot see the sky, the GPS unit will not receive the satellite signal. This problem is overcome by using "offsets" when determining a fix. Offsets require the GPS unit to be located in an adjacent open area where a fix can be obtained, at a measured distance and direction from the stream. Remote antennas have also proven useful to acquire signals under stream canopy cover. The antenna, attached to a pole, is moved and tilted around until satellites are "locked on".

Spherical Densiometer

The spherical densiometer can be used as a hand held instrument to estimate relative vegetative canopy closure or canopy density caused by vegetation. Vegetation canopy closure is the area of the sky over the selected stream channel that is bracketed by vegetation (regardless of density). Canopy density is the amount of the sky blocked within the closure by vegetation. Canopy closure can be constant throughout the season if fast growing vegetation is not dominant, but density can change drastically if canopy vegetation is deciduous.

Spherical densiometers are produced with either convex or concave reflecting surfaces. These instructions are for a convex (Model A) spherical densiometer. The mirror surface of the densiometer has 37 grid intersections forming 24 squares. At a probability level of 95 percent, tests show the average measurements of the same overstory area can be expected to be within ± 2.4 percent of the mean. Because the instrument has a curved (convex or concave) reflecting surface resulting in a field that includes lateral as well as overhead positions, an overlap of side readings occurs when readings are taken from the same point. To account for this bias, the modifications developed by Strichler (1959) are used and modified to more accurately measure canopy closure and density. Strichler uses only 17 of the line intersects as observation points by taping a right angle on the mirror surface (Figure M- 1).

For Stream Orders 1 Through 4 - Stand in the middle of the habitat type area and in the center of the stream facing downstream. The densiometer is held in the hand, in front of the body at about waist level, with the arm from the hand to the elbow parallel to the water surface. The convex densiometer is held away from the observer's body with the apex of the V pointed toward the observer. The observer's eye reflection should be seen along the margin of the original grid (Figure M-1). Level the densiometer using the bubble indicator and maintain the level and standard eye positions while recording. The grid between the V formed by the tape encloses 17 observation points. Each point has a value of 1.5 percent when four different recordings are made. The number of points (line grid intersects) that are covered by vegetation are counted when measuring canopy density. The number of points surrounded by vegetation are counted when measuring canopy closure. Measurements are taken in the four quadrants while standing on the same point (facing downstream, right bank, upstream, left bank).

The points counted for each reading are totaled and multiplied by 1.5 to obtain the percentage of canopy density or closure.

CALIFORNIA SALMONID STREAM HABITAT RESTORATION MANUAL

If all possible observation points are counted the total value will be 102 percent ($68 \times 1.5 = 102$). Although this error is small and not considered important for comparisons of relative values, the following correction factor can be applied to determine the correct percentile:

<u>Calculated value</u>	<u>Subtract from Calculated value</u>
less than 30	0
30 to 60	-1
over 60	-2

Example: $(8+11+7+12)(1.5) = 57\%$

subtract 1% = 56% density

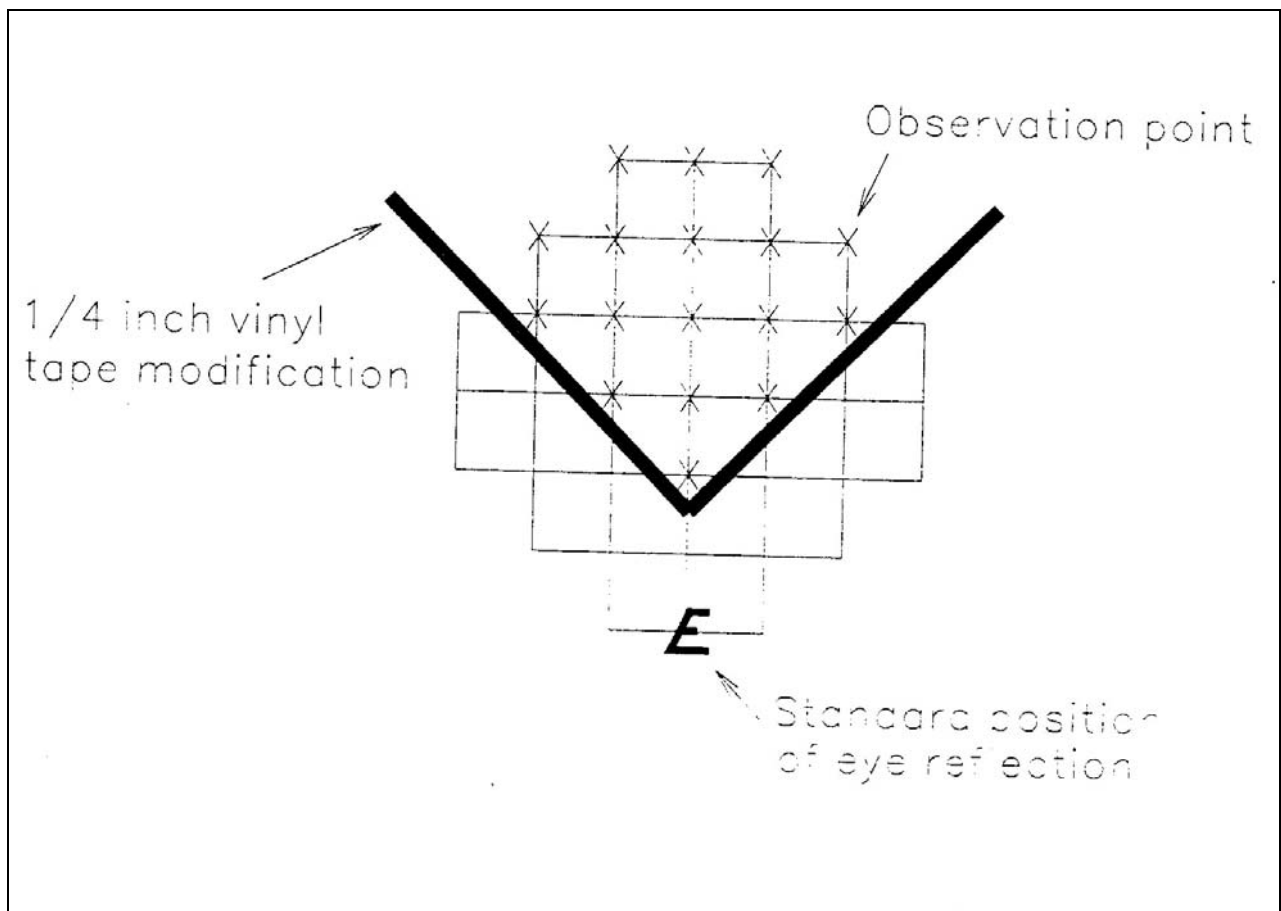

Figure M-1. Modified grid of convex spherical densiometer showing the 17 observations points (X's) and the position of the observer's eye reflection.

CALIFORNIA SALMONID STREAM HABITAT RESTORATION MANUAL

REFERENCES

- Platts, W.S., D. Amour, G.D. Booth, M. Gryant, J.L. Bufford, P. Culpin, S. Jensen, G.W. Lienkaemper, G.W. Minshall, S.B. Monsen, R.L. Nelson, J.R. Sedell, and J.S. Tuhy. 1987. Methods for Evaluating Riparian Habitats with Applications to Management. US Dept of Agriculture, Forest Service, Intermountain Research Station, General Technical Report INT-221.
- Strichler, G.S. 1959. Use of the densiometer to estimate density of forest canopy on permanent sample plots. Research Note INT-180. Portland, OR: U.S. Department of Agriculture, Forest Service, Pacific Northwest Forest and Range Experiment Station, 5p.

CALIFORNIA SALMONID STREAM HABITAT RESTORATION MANUAL

APPENDIX N.

PERMITS, AGREEMENTS, AND ENVIRONMENTAL DOCUMENTS

Each instream fish habitat restoration project requires some type of permit, although the number and type of permits necessary will depend on the type of project being considered. One or more of the following permits may be required:

- **Access Agreement.** This agreement is necessary to not only do the development work, but to enter onto property other than your own to do preliminary survey work. This agreement must be reached between the project sponsor and the property owner or manager (examples 1 and 2).
- **Streambed Alteration Agreement.** This agreement, issued by the Department of Fish and Game, is necessary to perform any physical manipulation of the stream, including vegetation, within the high water mark. (Fish and Game Code, Sections (1601/1603))
- **U.S. Army Corps of Engineers 404 Permit.** This permit, required pursuant to the Clean Water Act, may or may not be needed, but if the project proposes removal or placement of any materials in the stream area, or if the project area is a wetland, then the project proponent must apply to the Corps of Engineers to determine if a permit is necessary.
- **U.S. Army Corps of Engineers Section 10 Permit.** This permit, required pursuant to the Harbors and Rivers Act, is to be obtained for any construction between high water marks of navigatable rivers.
- **Section 401 of the Clean Water Act.** Section 401 of the Clean Water Act requires that the California Regional Water Quality Control Board determine consistency between proposed projects, California water quality laws, and certain sections of the Clean Water Act. The California Regional Water Quality Control Board has established specific procedures for implementing this section. The project proponent may be required to submit a "Request for Certification" form to the California Regional Water Quality Control Board.
- **Department of Fish and Game Trapping and Rearing Permit.** If your restoration project is for to rearing fish, then a trapping and rearing permit must be obtained from the Department before any fish may be handled. This permit process requires the applicant to submit and have approved a five-year management plan before the permit will be issued (Appendix B). Contact the local DFG district fishery biologist.

CALIFORNIA SALMONID STREAM HABITAT RESTORATION MANUAL

- **County and State Right-of-Way permits.** If your project is near any roads it could require agreements or permits with county and state public works departments. In addition, many counties have ordinances against working within a riparian corridor along a stream area. This usually falls under the county planning department.
- **State Lands Commission.** State Lands Commission is a permitting agency responsible for riverbed lands owned in fee by the State as sovereign lands, subject to the public trust for water-related commerce, navigation, fisheries, recreation, open space, and habitat. Project proponents should contact the State Lands Commission to determine if the project falls under Commission jurisdiction.
- **California Environmental Quality Act (CEQA).** Anytime an individual or a group (including public agencies), contracts with the Department of Fish and Game for fish habitat restoration projects, an environmental review is necessary. Individuals or groups conducting habitat restoration projects in a volunteer capacity may also need to have an environmental review of proposed projects, and should discuss proposed projects with the DFG district fishery biologist during the planning stages.
- **National Environmental Policy Act (NEPA).** This applies to projects which are carried out, financed, or approved in whole or part by federal agencies.
- **National Marine Fisheries Service (NMFS).** Written authorization must be obtained for any activities that may impact a federally listed species.

California Environmental Quality Act (CEQA)

Anytime an individual or group enters into a contract with the Department of Fish and Game, or the Wildlife Conservation Board, an environmental review of the project is necessary. A "project" is defined as any action which may result in a physical change in the environment. This is the case in any fish habitat restoration project.

POLICY

California Department of Fish and Game (DFG) policy requires that consideration of potential environmental impacts of all actions is of highest priority, and that DFG shall involve affected Federal, State, and local agencies, private organizations, and members of the public to the fullest extent practicable in the environmental assessment process.

CALIFORNIA SALMONID STREAM HABITAT RESTORATION MANUAL

PROCESS

Fish and Game personnel will conduct an internal informal consultation with appropriate staff to determine CEQA documentation needed for its projects based on interpretation of the CEQA statutes and guidelines. Projects may be found to be categorically exempt. If this is the level of documentation necessary then a categorical exemption will be prepared, circulated within the Department, and then filed in the Governor's Office of Planning and Research, State Clearinghouse. If projects do not qualify for this exemption, then it is raised to the next level of environmental review, Negative Declaration. If a Negative Declaration is not sufficient then an Environmental Impact Report (EIR) must be prepared.

CATEGORICAL EXEMPTION

Categorically exempt projects are those which fall within one of many classes which have been determined by the Secretary for Resources not to have significant adverse environmental effects. An environmental checklist (example 3) and initial study is used to determine if the project is categorically exempt.

NEGATIVE DECLARATION

A negative declaration consists of an initial study, environmental checklist and a formal finding that the project will not have a significant adverse effect. The document contains: 1) description and title of the project; 2) location of the project with accompanying maps; 3) proposed finding that the project will not have significant adverse effect on the environment; 4) copy of the initial study documenting reasons to support the finding; and 5) mitigation measures, if any, included in the project to avoid potentially significant negative effects.

ENVIRONMENTAL IMPACT REPORT

An Environmental Impact Report is an informational document that must be considered by each affected agency prior to its approval or disapproval of a project. Environmental Impact Reports provide agencies and the public with detailed information about the environmental effects of proposed projects; lists ways in which the significant effects of such a project might be minimized; and indicates alternatives to projects. This level of review is time consuming and expensive and would reduce the cost effectiveness of most fish habitat restoration projects.

**CALIFORNIA SALMONID STREAM
HABITAT RESTORATION MANUAL**

**EXAMPLE
(RIPARIAN AREA MANAGEMENT PLAN AGREEMENT)
ACME STUMP GRUBBERS**

P.O. Box 456
Halfway Hill, CA 95677

RIPARIAN AREA MANAGEMENT PLAN AGREEMENT

I. PURPOSE

The following agreement details the requirements of both the landowner and the Acme Stump Grubbers regarding a livestock exclusion, riparian vegetation restoration project on the real property controlled by the landowner named below. Said property is located approximately two miles upstream of the mouth of Trickle Creek, tributary to Ample Creek (see map attached to proposal).

I, _____, hereinafter called "Landowner", am aware that a riparian vegetation restoration project has been submitted to the California Department of Fish and Game for funding consideration. I understand the objectives of the project as proposed in the Trickle Creek Stream Restoration Project #1. The project has been explained to me by Acme Stump Grubbers. I support the goals of the project.

For the purpose of this agreement, riparian area shall be defined as the area, including the necessary fence(s), between the fence(s) and the middle of the stream channel. This specifically includes the stream bank and associated vegetation within this area.

I understand the purpose of the livestock exclusion fence detailed in the proposal mentioned above is to exclude livestock from the riparian zone on my property. The fence will allow mature riparian vegetation to become reestablished. A mature riparian community will provide increased stream bank stability, shade and cover for fish and wildlife. The project can only be successful if the fence is maintained long enough for the riparian community to become reestablished.

II. REQUIREMENTS

Acme Stump Grubbers agrees to:

1. Contingent on receiving funding from the California Department of Fish and Game, provide monies for purchase of materials and supplies to construct livestock exclusion fencing on landowners real property as described in proposal.
2. Provide labor necessary for initial installation of livestock exclusion fencing on landowner's real property.

CALIFORNIA SALMONID STREAM HABITAT RESTORATION MANUAL

3. Provide technical assistance during the contract life for management of the riparian area.

Landowner agrees to:

1. Maintain livestock exclusion fence(s) for a period of 10 years from the last date of execution shown below. Maintenance will include repair of fences to a level that will effectively exclude livestock from the livestock exclusion project area. Maintenance will not include damage that exceeds 50 percent of the fence due to natural disaster.
2. Totally exclude livestock from the project area until newly planted trees become well-established. If controlled, limited grazing is essential, landowner will submit a written plan, to the California Department of Fish and Game for approval, that will detail how the limited grazing will not cause damage to desirable vegetation or stream banks within the project area.
3. Once it has been established by the California Department of Fish and Game that limited grazing within the project area is acceptable, grazing will be limited to an amount that will not cause damage to the newly planted trees or stream banks. Generally acceptable limits will be to remove 50 percent of the current year growth of grasses and forbs. Livestock shall be removed before they begin to browse on woody plants. Newly planted trees damaged by browsing will be replaced at landowners expense.

III. DURATION OF NOTICE

The term of this agreement shall be _____ months for work performance, and 10 years for maintenance, inspection, and monitoring purposes from the last date of execution shown below. This is provided that Acme Stump Grubbers or the California Department of Fish and Game shall give Landowner reasonable actual notice prior to each needed access. Reasonable and actual notice may be given by mail, in person, or by telephone.

This agreement can be amended only by prior written agreement of both parties executing this permit.

**CALIFORNIA SALMONID STREAM
HABITAT RESTORATION MANUAL**

IV. LIABILITIES

Reasonable precautions will be exercised by Acme Stump Grubbers to avoid damage to persons and property.

Acme Stump Grubbers agrees to indemnify and hold harmless the landowner and agrees to pay for reasonable damages proximately caused by reason of the uses authorized by this permit, except those caused by the gross negligence or intentional conduct of the landowner.

Date _____

Landowner Signature

Date _____

Chuck E. Chainsaw
Acme Stump Grubbers

**CALIFORNIA SALMONID STREAM
HABITAT RESTORATION MANUAL**

**EXAMPLE
(LANDOWNER AGREEMENT COOPERATIVE FISH REARING PROJECTS)
Dry Creek Salmon Enhancement Project
P.O. Box 123, Pine Valley, CA 95678
Access/Entry Agreement**

I. PURPOSE

The following agreement details requirements of both the landowner and the Dry Creek Salmon Enhancement Project regarding establishment of a fishery enhancement project on real property controlled by the landowner named below. Said property is located four and one half miles from the mouth of Dry Creek, tributary to Muddy River (See map attached to proposal).

I, _____, hereinafter referred to as "Landowner", am aware that a fish rearing facility and trapping sites are located on Dry Creek, tributary to Muddy River, located on Big Trees Lumber Company property. The project has been explained to me by the Dry Creek Salmon Enhancement Project. I support the goals of the project.

II. ACCESS PERMISSION

Landowner hereby grants Dry Creek Salmon Enhancement Project and California Department of Fish and Game representatives permission to enter onto real property owned by the Landowner to perform pre-project evaluation; and, if an agreement for the project is entered into between the Dry Creek Salmon Enhancement Project and the California Department of Fish and Game, Landowner grants permission to perform the fishery enhancement work, to conduct field inspections, and to monitor project for needed maintenance or equipment removal for the life of the project. Access shall be limited to those portions of landowner's real property where actual fishery enhancement work is to be performed and those additional portions of real property which must be traversed to gain access to the work site.

III. DURATION OF NOTICE

The term of this agreement shall commence upon signing of this Agreement and terminate on _____. This Agreement may be terminated by either party at any time, without cause, upon sixty (60) days written notice to the other party.

**CALIFORNIA SALMONID STREAM
HABITAT RESTORATION MANUAL**

IV. LIABILITIES

Reasonable precautions will be exercised by Dry Creek Salmon Enhancement Project to avoid damage to persons and property.

Dry Creek Salmon Enhancement Project agrees to indemnify and hold harmless the landowner and agrees to pay for reasonable damages proximately caused by reason of the uses authorized by this permit, except those caused by the gross negligence or intentional conduct of the landowner.

Date _____

Landowner Signature

Date _____

Bob R. Float
Dry Creek Salmon Enhancement Project

**CALIFORNIA SALMONID STREAM
HABITAT RESTORATION MANUAL**

ENVIRONMENTAL CHECKLIST FORM

PROJECT LOCATION:

	City	County
--	------	--------

PROJECT ADDRESS:

PROJECT DESCRIPTION:

ENVIRONMENTAL IMPACTS:

(CEQA requires that an explanation of all "yes" and "maybe" answers be provided along with this checklist, including a discussion of ways to mitigate the significant effects identified. You may attach separate sheets with the explanations.)

	<u>Yes</u>	<u>Maybe</u>	<u>No</u>
I. EARTH. <i>Will the proposal result in:</i>			
a. Unstable earth conditions or changes in geological substructures?	_____	_____	_____
b. Disruptions, displacements, compaction or overcovering of the soil?	_____	_____	_____
c. Change in topography or ground surface relief features?	_____	_____	_____
d. The destruction, covering or modification of any unique geologic or physical features?	_____	_____	_____
e. Any increase in wind or water erosion of soils, either on or off the site?	_____	_____	_____

**CALIFORNIA SALMONID STREAM
HABITAT RESTORATION MANUAL**

	<u>Yes</u>	<u>Maybe</u>	<u>No</u>
f. Changes in deposition or erosion of beachsands, or changes in siltation, deposition or erosion which may modify the channel of a river or stream or the bed of the ocean or any bay, inlet or lake?	_____	_____	_____
g. Exposure of people or property to geologic hazards, such as earthquakes, landslides, mudslides, ground failure, or similar hazards?	_____	_____	_____
 II. WATER. <i>Will the proposal result in:</i>			
a. Substantial changes in currents, or the course of direction of water movements, in either marine or freshwaters?	_____	_____	_____
b. Changes in absorption rates, drainage patterns, or the rate and amount of surface runoff?	_____	_____	_____
c. Changes in the amount of surface water in any water body?	_____	_____	_____
d. Discharge into surface waters, or in any alteration of surface water quality, including, but not limited to, temperature, dissolved oxygen, petroleum products or turbidity?	_____	_____	_____
e. Change in the quantity of ground waters, either through direct additions or withdrawals, or through interception of an aquifer by cuts or excavations?	_____	_____	_____
f. Substantial reduction in the amount of water otherwise available for public water supplies?	_____	_____	_____
g. Exposure of people or property to water related hazards such as flooding or tidal waves?	_____	_____	_____

**CALIFORNIA SALMONID STREAM
HABITAT RESTORATION MANUAL**

	<u>Yes</u>	<u>Maybe</u>	<u>No</u>
III. PLANT LIFE. <i>Will the proposal result in:</i>			
a. Change in the diversity of species, or number of any species, including upland, riparian and aquatic plants?	_____	_____	_____
b. Reduction of the numbers of any unique, rare, or endangered species of plants?	_____	_____	_____
c. Introduction of new species of plants into an area, or in a barrier to the normal replenishment of existing species?	_____	_____	_____
d. Reduction in acreage of any agricultural crop?	_____	_____	_____
IV. ANIMAL LIFE. <i>Will the proposal result in:</i>			
a. Change in the diversity of species, or numbers of any species of animals (birds; land animals, including reptiles; fish and shellfish; benthic organisms or insects)?	_____	_____	_____
b. Reduction of the numbers of any unique, rare, or endangered species or animals?	_____	_____	_____
c. Introduction of new species of animals into an area, or result in a barrier to the migration or movement of animals?	_____	_____	_____
d. Deterioration to existing fish or wildlife habitat?	_____	_____	_____
e. Result in activities during sensitive life stages, i.e. nesting, spawning, incubation, fry emergence, etc.	_____	_____	_____
V. NOISE.			
a. Will the proposal result in increases in existing noise levels?	_____	_____	_____

**CALIFORNIA SALMONID STREAM
HABITAT RESTORATION MANUAL**

	<u>Yes</u>	<u>Maybe</u>	<u>No</u>
VI. LAND USE.			
a. Will the proposal result in substantial alteration of, or conflict with, the present or planned land use of an area, i.e. mining or timber harvest?	_____	_____	_____
VII. NATURAL RESOURCES.			
a. Will the proposal result in an increase in the rate of use of any natural resources?	_____	_____	_____
VIII. RISK OF UPSET. <i>Will the proposal involve:</i>			
a. A risk of an explosion or the release of hazardous substances (including, but not limited to oil, pesticides or chemicals) in the event of an accident or upset conditions?	_____	_____	_____
b. Possible interference with an emergency response plan or an emergency evacuation plan?	_____	_____	_____
IX. TRANSPORTATION/CIRCULATION. <i>Will the proposal result in:</i>			
a. Generation of substantial additional vehicular movement?	_____	_____	_____
b. Substantial impact upon existing transportation systems?	_____	_____	_____
X. PUBLIC SERVICES. <i>Will the proposal have an effect upon, or result in a need for new or altered governmental services in any of the following areas:</i>			
a. Parks or other recreational facilities?	_____	_____	_____
b. Maintenance of public facilities, including roads?	_____	_____	_____

**CALIFORNIA SALMONID STREAM
HABITAT RESTORATION MANUAL**

	<u>Yes</u>	<u>Maybe</u>	<u>No</u>
XI. HUMAN HEALTH.			
a. Will the proposal result in exposure of people to potential health hazards?	_____	_____	_____
XII. AESTHETICS. <i>Will the proposal result in:</i>			
a. The obstruction of any scenic vista or view open to the public?	_____	_____	_____
b. The creation of an aesthetically offensive site open to public view?	_____	_____	_____
XIII. RECREATION.			
a. Will the proposal impact upon the quality or quantity of existing recreational opportunities including boating or kayaking?	_____	_____	_____
XIV. CULTURAL RESOURCES. <i>Will the proposal:</i>			
a. Result in the alteration of or the destruction of a prehistoric or historic archaeological site?	_____	_____	_____
b. Result in adverse physical or aesthetic effects to a prehistoric or historic building, structure, or object?	_____	_____	_____
c. Have the potential to cause a physical change which would affect unique ethnic cultural values?	_____	_____	_____
d. Restrict existing religious or sacred uses within the potential impact area?	_____	_____	_____

**CALIFORNIA SALMONID STREAM
HABITAT RESTORATION MANUAL**

Yes Maybe No

XV. MANDATORY FINDINGS OF SIGNIFICANCE.

- | | | | |
|--|-------|-------|-------|
| <p>a. Potential to degrade: Does the project have the potential to degrade the quality of the environment, substantially reduce the habitat of a fish or wildlife species, cause a fish or wildlife population to drop below self-sustaining levels, threaten to eliminate a plant or animal community, reduce the number or restrict the range of a rare or endangered plant or animal or eliminate important examples of the major periods of California history or prehistory?</p> | _____ | _____ | _____ |
| <p>b. Short-term: Does the project have the potential to achieve short-term, to the disadvantage of long-term, environmental goals? (A short-term impact on the environment is one which occurs in a relatively brief, definitive period of time. Long-term impacts will endure well into the future.)</p> | _____ | _____ | _____ |
| <p>c. Cumulative: Does the project have impacts which are individually limited, but cumulatively considerable? (A project may impact on two or more separate resources where the impact on each resource is relatively small, but where the effect on the total of those impacts on the environment is significant.)</p> | _____ | _____ | _____ |
| <p>d. Substantial adverse: Does the project have environmental effects which will cause substantial adverse effects on human beings, either directly or indirectly?</p> | _____ | _____ | _____ |

XVI. DISCUSSION OF ENVIRONMENTAL EVALUATION. (If more room is needed attach explanations to checklist.)

XVII. DISCUSSION OF LAND USE IMPACTS. (If more room is needed attach explanations to checklist.)

(Note: This is only a suggested form pursuant to CEQA Guidelines, Section 15063(d). Public agencies are free to devise their own format for initial studies. However, the DETERMINATION is an essential component of this form.)

CALIFORNIA SALMONID STREAM HABITAT RESTORATION MANUAL

APPENDIX O.

TEN PERCENT SAMPLING PROTOCOL FOR HABITAT TYPING INVENTORY SURVEYS

Since 1990 numerous anadromous salmonid streams in California have been inventoried for fish habitat utilizing fish habitat typing methods described by Flosi and Reynolds (1994). Habitat typing involves the identification, description, and measurement of distinct fish habitats within the wetted channel. Surveyors usually begin at the mouth of a stream and proceed upstream. They identify each fish habitat type and record up to 35 individual measurements or observations for each habitat type unit. Typically, this method is applicable in first through fourth order streams with an average wetted width of less than 75 feet. These streams can usually be waded. A team of two experienced surveyors are able to complete about one-half mile of stream (or about 100 habitat units) per day. The primary use of fish habitat typing data by the Department of Fish and Game, and others, is to identify and prioritize streams or stream reaches in need of restoration. The resulting stream descriptions are considered a general "basin level" view for planning purposes and not a rigorous "project level" view that describes site specific details. For example, a stream might reveal a lower than expected frequency of pools throughout the survey area, which indicates a potential restoration opportunity of deploying pool-forming structures.

Past practice has been to determine and record all characteristics of each habitat unit as called for on the Habitat Inventory Data Form. However, experience in analyzing over 200 stream habitat inventory data sets has indicated that adequate stream descriptive detail for "basin level" planning can be accomplished with a sampling level of about 10 percent. Possible strategies for subsampling habitat type units in streams or stream reaches at about a 10 percent level included:

- 1) a systematic sample with a random start of every tenth unit,
- 2) a systematic sample stratified by habitat type, where each habitat type was sampled at a pre-determined interval,
- 3) a 10% random sample of all habitat units,
- 4) a random sample within every 10 consecutive habitat units.

Each proposed sampling strategy has some drawbacks. The systematic random sample with a random start was perceived to be too non-random, except for the start. Both complete and systematic random sampling of habitat types requires prior knowledge of the population of habitat types available and is impractical for field application. A random sample of all habitat units is perhaps statistically the most sound, but might not reflect land use or ownership differences if a particular random sample allowed for no samples in some areas. Because of the desire to have samples selected throughout the entire stream reach, to avoid possible sampling gaps in some watershed ownership parcels, the stratified sampling method (strategy No. 4) was selected as the preferred sampling strategy. This sampling strategy was modified by adding to the randomly selected habitat type set, a sample set that included the first occurrence of each habitat type. This modification ensured that all habitat types were represented at least once in the entire sample.

CALIFORNIA SALMONID STREAM HABITAT RESTORATION MANUAL

RECOMMENDATIONS

1. Segment the stream into sub-reaches consisting of 10 consecutive habitat units. The Habitat Inventory Data Form contains spaces for 10 habitat units per page. Habitat unit numbers begin at the downstream end of the survey and continue sequentially upstream to the end of the survey area.
2. Obtain a random number table or a 10-sided die.
3. Randomly select a number from one through ten by tossing a die or using the random number table.
4. The number selected is the first randomly sampled habitat unit within the first 10 habitat units. Mark this habitat unit on Form 1 of the Habitat Inventory Data Form. Now, randomly select another number from one to ten. This is the habitat unit to randomly sample in the second set of 10 habitat units. If the number is "3", select the 3rd habitat unit on Form 2, or habitat unit No. 13. Mark this number on Form 2 of the Habitat Inventory Data Form. Continue selecting random numbers and marking forms to indicate random habitat units until you have enough forms for the day.

Hint: use a felt tipped marking pen to highlight the entire column of the randomly selected unit.

5. Begin the survey at the downstream end of a stream, reach or stream channel type change.
6. The actual survey involves:
 - a. Walk and measure the entire stream length.
 - 1). Identify every habitat unit by type.
 - 2). Measure the length of each unit.
 - b. Record all measurements and observations (complete sample) for each first-time encounter of each habitat type found in a stream channel type reach.
 - c. Record all measurements and observations (complete sample) for every randomly selected habitat unit number.

Optimizing pool habitat is a high priority for restoration projects. To enable these survey data to function as a crude monitoring tool of pool scour and deposition dynamics, including relative quality of spawning substrate in pool tail crests, the following parameters are recommended for each pool habitat:

CALIFORNIA SALMONID STREAM HABITAT RESTORATION MANUAL

- d. Measure maximum depth, pool tail crest depth and pool tail embeddedness in all pool habitat types.

Another high priority restoration prescription is improvement of riparian canopy density. To enable graphic display and analysis of canopy densities linearly along a stream reach, the following is recommended:

- e. Determine canopy density in at least every third habitat unit.

Refer to following example:

EXAMPLE HABITAT INVENTORY SURVEY PROCEDURE FOR MODIFIED 10 PERCENT RANDOM SAMPLE

Random numbers: 6, 3, 4, 9, 4, 3, 8, 5, 2, 7, 6, 6, 1

Habitat unit No.	Habitat type	Action
1	LGR	Complete sample, first occurrence
2	RUN	Complete sample, first occurrence
3	MCP	Complete sample, first occurrence
4	LGR	Length and habitat type only
5	RUN	Length and habitat type only
6 Random	LSL	Complete sample, random selection
7	GLD	Complete sample, first occurrence
8	LGR	Length and habitat type only
9	LSR	Complete sample, first occurrence
10	RUN	Length and habitat type only
11	LGR	Length and habitat type only
12	MCP	Length, habitat type, max depth, pool tail depth and embeddedness, canopy
13 Random	RUN	Complete sample, random selection
14	LGR	Length and habitat type only
15	CRP	Complete sample, first occurrence
16	POW	Complete sample, first occurrence
17	RUN	Length and habitat type only
18	LSL	Length, habitat type, max depth, pool tail depth and embeddedness
19	LGR	Length and habitat type only Canopy
20	GLD	Length and habitat type only
21	PLP	Complete sample, first occurrence
22	LGR	Length and habitat type only
23	LSR	Length, habitat type, max depth, pool tail depth and embeddedness
24 Random	LGR	Complete sample, random selection
25	RUN	Length and habitat type only

**CALIFORNIA SALMONID STREAM
HABITAT RESTORATION MANUAL**

Habitat unit No.	Habitat type	Action
26	GLD	Length and habitat type only
27	LSBo	Complete sample, first occurrence
28	SRN	Complete sample, first occurrence
29	LSR	Length, habitat type, max depth, pool tail depth and embeddedness
30	LGR	Length and habitat type only
-----Stream channel type changes to A3 - defines a NEW reach		
31	LSB	Complete sample, first occurrence
32	HGR	Complete sample, first occurrence
33	POW	Complete sample, first occurrence
34	PLP	Complete sample, first occurrence
35	LGR	Complete sample, first occurrence
36	RUN	Complete sample, first occurrence
37	LSB	Length, habitat type, maximum depth, pool tail depth and embeddedness
38	HGR	Length and habitat type only
39 Random	CCP	Complete sample, random selection
40	LGR	Length and habitat type only

CALIFORNIA SALMONID STREAM HABITAT RESTORATION MANUAL

APPENDIX P.

CALIFORNIA SALMONID FISHES

Anadromous Species

Taxonomy. Since recent taxonomic changes have included steelhead and cutthroat within the genus *Onchorhynchus*, there are now four species of salmon found in California streams in significant numbers. They are chinook salmon (*Oncorhynchus tshawytscha*), coho salmon (*Oncorhynchus kisutch*), steelhead trout (*Oncorhynchus mykiss*), and coast cutthroat (*Oncorhynchus clarkii*). These species are generally found along the west coast of the North American continent from the Bering Sea to central California, with coast cutthroat range and population numbers more limited than the others towards the south. Typically, the fish farther north grow slower and remain longer in fresh water as juveniles before migrating to the ocean and beginning their rapid growth phase in salt water. Specifics of the life cycles of these fish vary from place to place depending on climate, food supply, and other critical factors.

Races. The term "race", as used here, describes temporal occurrence of upstream migrating adults within a river system, and is not meant to imply any genetic distinction between different "races" of the same species. Races of anadromous salmonids are presently identified according to the time of year the adult fish first enter fresh water, although some are identified by their geographic range. Therefore, a spring-run steelhead, sometimes called a "summer steelhead" because it is seen in fresh water during the summer, is a steelhead trout that usually begins its upstream migration in the springtime. In California there are spring-, fall-, and winter-run steelhead trout; spring-, fall-, late-fall-, and winter-run chinook salmon; and fall- and winter-run coho salmon. Information on coast cutthroat trout is inadequate to say much more than that they are variable.

Chinook salmon that enter coastal streams in early winter have a shorter freshwater journey and spawn much earlier than Sacramento River winter-run chinook. Coastal "winter-run" chinook that spawn almost immediately after entering fresh water are more properly classed as late fall-run, whereas the Sacramento River winter-run spawning does not begin until April or May. Sacramento River winter-run chinook spawn in June, July, and August. Almost all north coast salmon spawning occurs from mid-November through February. Steelhead spawning seasons begin a little later and run into April.

There are flow timing differences between streams, and all streams do not support the same species or races of salmonids. For example, timing for the adult run of salmon and steelhead in the Klamath River system is typically earlier than for the Eel or Smith Rivers. Many coastal streams (including the Eel and Smith Rivers) do not have sufficient flows to allow adult migration until rains have increased discharge in November and December. In such streams, low flows control upstream migration timing and, therefore, spawning cycles.

CALIFORNIA SALMONID STREAM HABITAT RESTORATION MANUAL

Adult Life Histories

Chinook Salmon

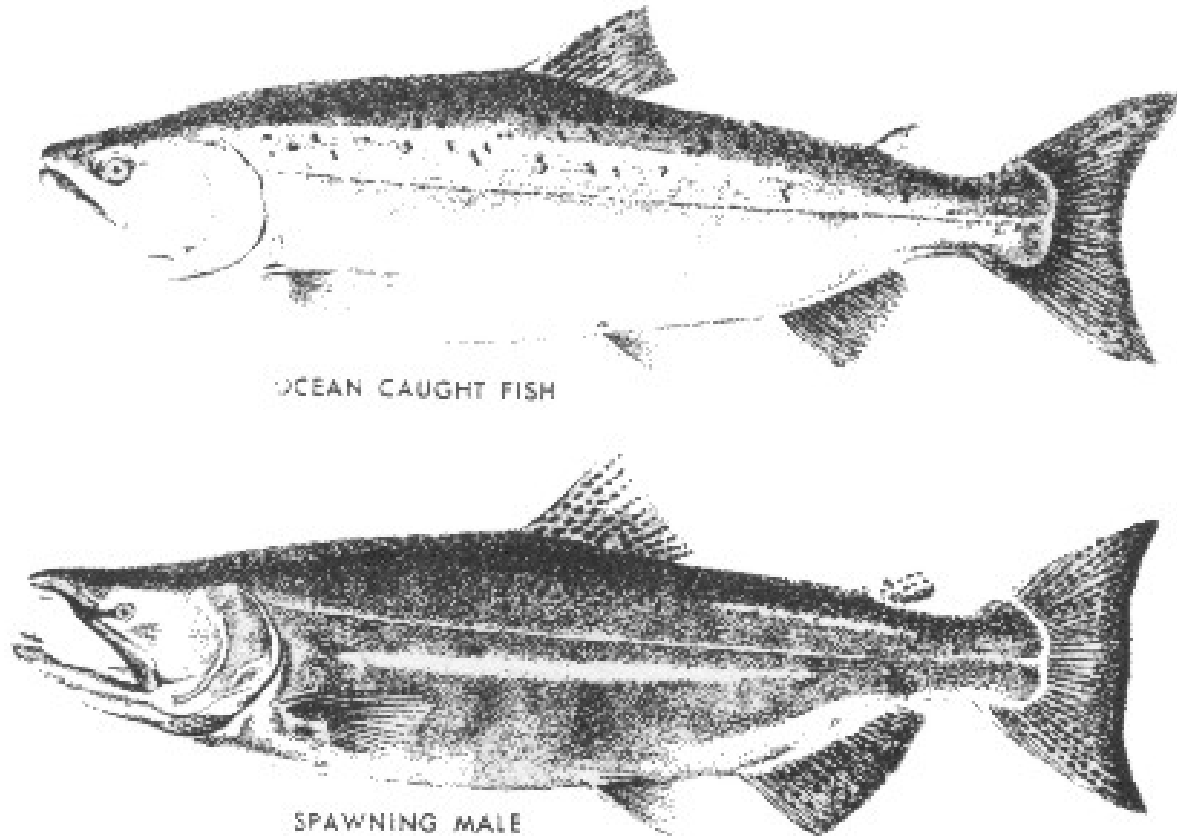

Chinook salmon runs are categorized by the time of year during which they enter the river systems on their spawning migration. In California's coastal rivers there are two clearly identified runs, or races, of chinook salmon. They are fall-run and spring-run. Fall-run chinook leave ocean waters and begin to enter the river systems in late August and September, and then proceed upstream if water temperatures are cool enough and if flow is adequate to allow their passage (Table P-1). If conditions in the river are not suitable, fall-run chinook remain in the ocean or in the lower river sections until early season storms raise stream flow and provide cooler water. Spawning usually occurs from October through January. Spring-run chinook enter river systems during the spring runoff period, remain in fresh water through the summer months, and begin spawning the following fall a little earlier than the fall-run fish. Spring-run spawning is usually completed from the end of September to mid-October. These fish have been designated as a species of special concern in California. In rivers that have both spring-and fall-run chinook, the spawning periods may overlap for several weeks. California also has late-fall-run and winter-run chinook, but they have only been formally identified in the Sacramento River system. The Sacramento River winter-run chinook salmon has been designated by the State of California and the United States Government as endangered.

CALIFORNIA SALMONID STREAM HABITAT RESTORATION MANUAL

Chinook salmon are riffle spawners and typically construct redd (nest) sites near the head of riffles in gravel 6 inches (15 cm) or less in diameter. During courtship, the female may dig several false redds before actually spawning, and communal or multiple redds are common under crowded conditions. As the female releases her eggs into the redd an attending male or males fertilize them. Upon completion of the spawning act, the female covers the eggs with 8-14 inches (20-36 cm) of gravel.

Chinook salmon die after spawning. During the period between spawning and death, the female may remain near or over the redd which may discourage excavation by other salmon that are seeking suitable places to spawn.

Eggs develop in gravel for about eight weeks (50-60 days) before hatching, depending on water temperatures (Table P-1). After absorption of the yolk sac, young salmon emerge from the gravel and begin actively foraging. Passive downstream movement of young chinook salmon begins shortly after emergence. Downstream movement is nearly complete by late June, at which time river flows are decreasing. At this time young chinook salmon are 3-5 inches (8-13 cm) long, and most are actively moving downstream. Most juveniles enter the ocean as fingerlings in the spring and early summer, but some may remain in streams or estuaries and enter the ocean as yearlings in the fall.

Coho Salmon

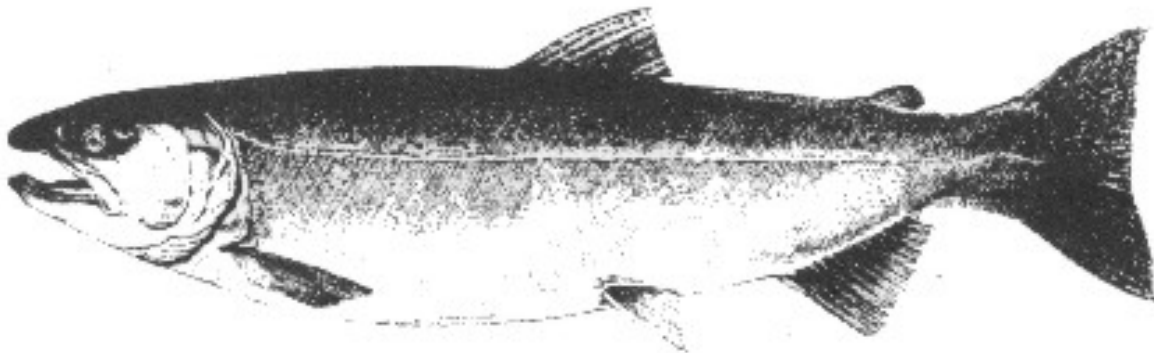

The spawning migration of coho salmon is similar to that of chinook salmon but starts later in the season. Like chinook, coho salmon are riffle spawners and their courtship and spawning are similar. Although there is some overlap of spawning habitats, coho salmon typically utilize smaller streams and gravel than do chinook.

Egg development is like that of chinook salmon, but after emergence, many coho salmon do not leave the river nursery area. Instead, coho salmon may remain a year or more before smolting (undergoing the changes necessary to enter saltwater) and entering the ocean. Yearling coho salmon enter the ocean during the spring when they are 5-6 inches long. In the smaller coastal streams, most coho enter the ocean during their first year as 1-3 inch fish.

CALIFORNIA SALMONID STREAM HABITAT RESTORATION MANUAL

Steelhead Trout

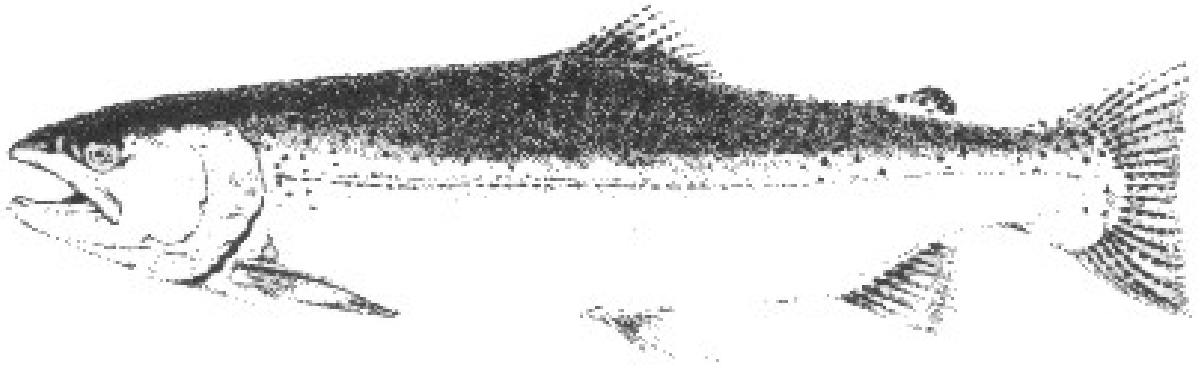

Adult steelhead enter river systems during most months of the year. Those entering during late summer through October are called fall-run steelhead, those entering during November through April are called winter-run steelhead, and those entering during May and June are called spring-run steelhead. In California, the Eel and Klamath-Trinity river systems have fall runs of predominately two-year-old steelhead returning from only two to four months in the ocean. These fish, called "half-pounders," range from 12 to 16 inches in length and do not mature to spawn during this migration.

Fall- and winter-run steelhead spawn a few weeks to a few months after they enter fresh water. Spring-run steelhead (descriptively named "summer steelhead") remain in the freshwater environment through the summer and spawn the following winter. Steelhead usually spawn in smaller tributary streams than salmon, and utilize smaller gravel. Spawning takes place from December to May. Egg development rate is temperature dependent and usually requires about 31 days at 50^E Fahrenheit (Table P-1).

Unlike chinook and coho, up to 50 percent of adult steelhead survive to spawn in more than one season. First-time spawners are usually three or four years old and will have spent one or two years in fresh water and one or two years in the ocean. Most steelhead enter the ocean after spending two years in freshwater.

CALIFORNIA SALMONID STREAM HABITAT RESTORATION MANUAL

Coastal Cutthroat Trout

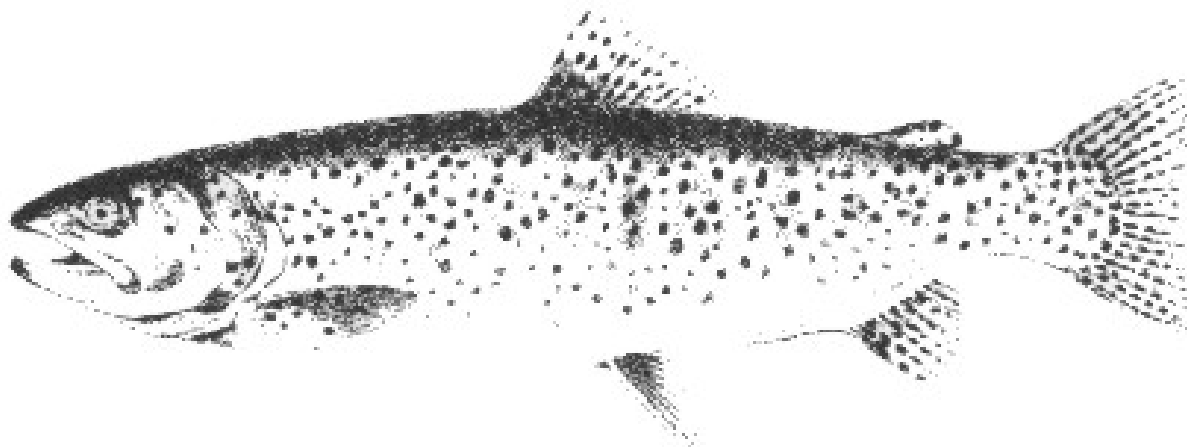

Coastal cutthroat trout are found in coastal streams from the lower Van Duzen River north, within approximately 25 miles from the coast. Their upstream migration usually occurs in the late fall or early winter and, typically, spawning takes place in small streams. Coast cutthroat may not venture far in the ocean and often return to fresh water after one year or less in salt water.

Juveniles rear for two or more years in fresh water before migrating to the sea, and some fish live out their lives as freshwater residents. Reproducing populations of these fish are frequently found in small coastal streams above barriers to steelhead upstream migration. There is a valid concern that when steelhead trout are provided access to these areas, they may eliminate or partially replace the coast cutthroat trout through competition for food and living space.

Juvenile Life Histories

The rate at which salmon and trout eggs mature and hatch is controlled by their environment. Generally, if the water is above 50E Fahrenheit, oxygen supply is adequate, and silt and algae are not excessive, then the eggs develop and hatch at an optimum rate. However, if water temperature gets much above 58E Fahrenheit, the eggs will not mature (Table P-1). Various races of salmonids have evolved to spawn at the most opportune times and locations available within their home streams that will provide their eggs with the best chance for survival.

Chinook salmon juveniles may take up temporary residence in their natal environment (the surroundings where they emerged from the gravel) or they may begin to passively be carried downstream while they are feeding, and seek escape cover when threatened. Although in more northerly streams, coho typically leave fresh water as 1- or 2-year-olds, out-migration as first-year juveniles appears to be common for California coho. Juvenile coho numbers in coastal streams are observed to diminish rapidly during the spring months, and coho have been monitored moving downstream through lower stream reaches. This departure is often related to low flows and elevated water temperatures. Because adult coho return to the streams in greater numbers than could be accounted for by out migrating 1- or 2-year olds, 0-age fish apparently contribute significantly to California populations.

Juvenile salmon and steelhead have different habitat preferences in a stream. Chinook and coho

CALIFORNIA SALMONID STREAM HABITAT RESTORATION MANUAL

prefer pool environments, and steelhead tend to select glides and riffles. This does not mean that they will not be seen together, and their preferred feeding or resting habitat is not necessarily the habitat they will be found in when disturbed. Generally, as fish grow older and larger they require larger habitat. Therefore, if they rear for one or more years in fresh water, they will need adequate space and water quality.

Juvenile Salmonids

Chinook Salmon

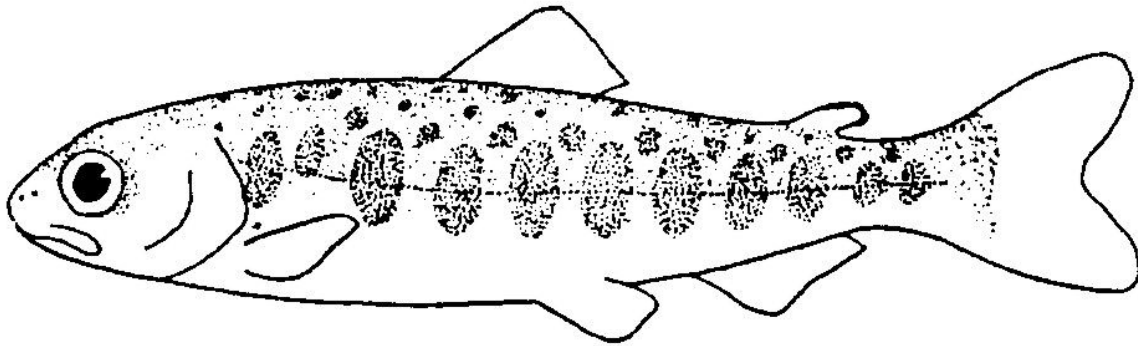

Coho Salmon

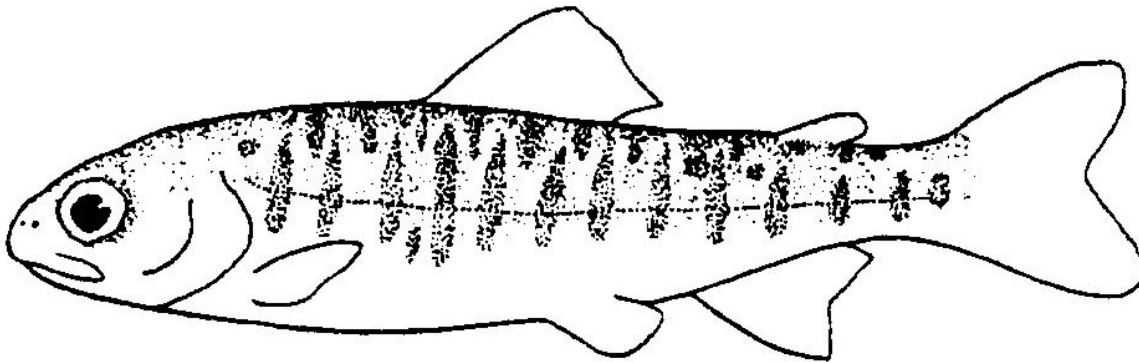

CALIFORNIA SALMONID STREAM HABITAT RESTORATION MANUAL

Steelhead Trout

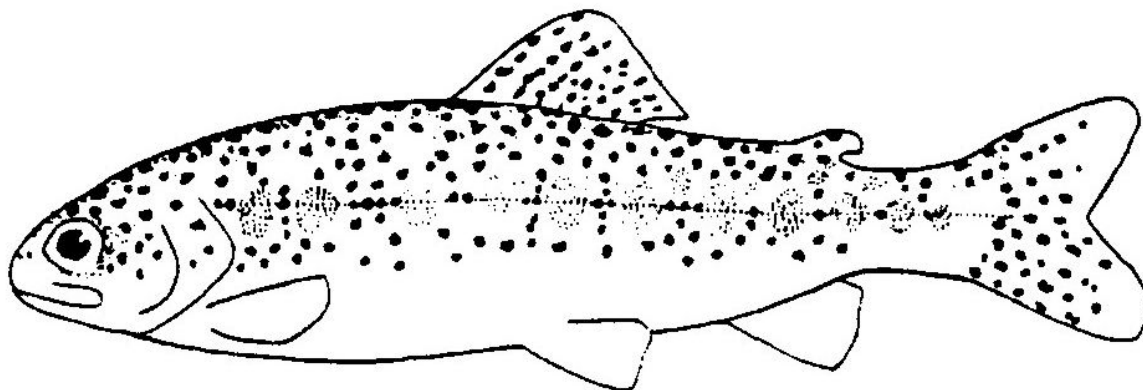

Coastal Cutthroat Trout

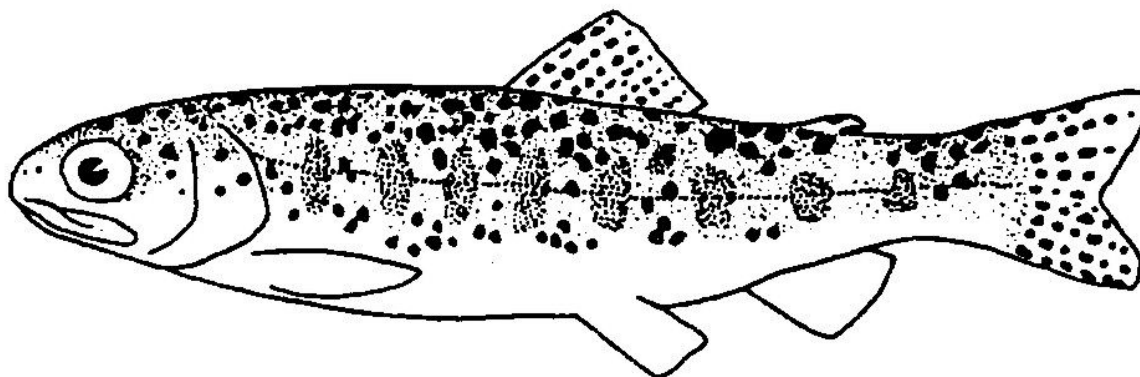

Resident Species

In addition to four anadromous salmonids, there are ten species or subspecies of native resident trout, and three species of non-native resident trout in California. Coastal rainbow trout, (*Oncorhynchus mykiss irideus*), is the most widespread and popular resident trout in California. This is the resident or non-anadromous form of steelhead trout. Eagle Lake rainbow trout, (*Oncorhynchus mykiss aquilarum*), are a highly specialized form of rainbow, capable of surviving in highly alkaline waters. They provide a popular, hatchery supported sport fishery in Eagle Lake. The three subspecies of golden trout include: 1) Volcano Creek (S. F. Kern River) golden trout, (*Oncorhynchus mykiss aquabonita*); 2) Little Kern River golden trout, (*O. m. whitei*); and 3) Kern River rainbow trout, (*O. m. gilberti*). Although the native ranges of these species were confined to the Kern River drainage, golden trout have been transplanted in many suitable waters throughout the state. Resident forms of cutthroat trout include Lahontan cutthroat trout (*Oncorhynchus clarki henshawi*), and Paiute cutthroat trout (*O. c. seleniris*). Lahontan cutthroat trout are the most widespread and the more popular sport fish of the two. California is also home to three remnant populations of redband trout, a close relative of the coastal rainbow. Although the taxonomic status of the redbands is presently unclear, California currently recognizes three subspecies, McCloud River redband trout (*Oncorhynchus mykiss* subspecies.), Goose Lake redband trout (*O. c.* subspecies), and Warner Lakes redband trout (*O. c.* subspecies). One native species of char, the

CALIFORNIA SALMONID STREAM HABITAT RESTORATION MANUAL

bull trout (*Salvelinus confluentus*) is now extinct in California.

Two of the most popular and easily recognized trout in California are non-natives, the brown trout (*Salmo trutta*) and the brook trout (*Salvelinus fontinalis*). A third non-native trout, the lake trout (*Salvelinus namaycush*), is locally popular in Lake Tahoe. All three of these species have established self-sustaining populations in many waters throughout the state.

Finally, a landlocked form of sockeye salmon, the Kokanee (*Oncorhynchus nerka*), is planted in several reservoirs throughout northern and central California and provides a popular fishery for the trout angler.

Resident salmonid adults spawn in fine gravel under conditions similar to those used by anadromous salmonids. Brook trout and Kokanee are capable of spawning in both streams and lake margins. Juvenile resident salmonids frequently rear and live out their life span in the immediate vicinity of their birthplace. Others may move downstream to larger streams or, like Kokanee, migrate to a lake environment.

Rainbow Trout

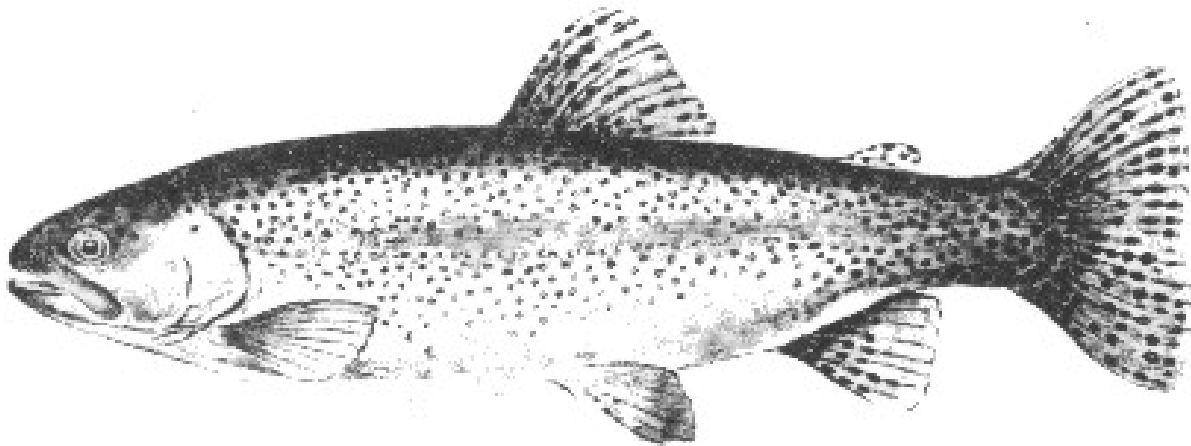

Rainbow trout are native and, partly as a result of being the fish most commonly raised and planted from the hatchery system, are widely distributed throughout California streams. They normally spawn in the spring in cold streams (50^E-58^E Fahrenheit) and rarely attain the size of steelhead (anadromous rainbow trout).

CALIFORNIA SALMONID STREAM HABITAT RESTORATION MANUAL

Lahontan Cutthroat Trout

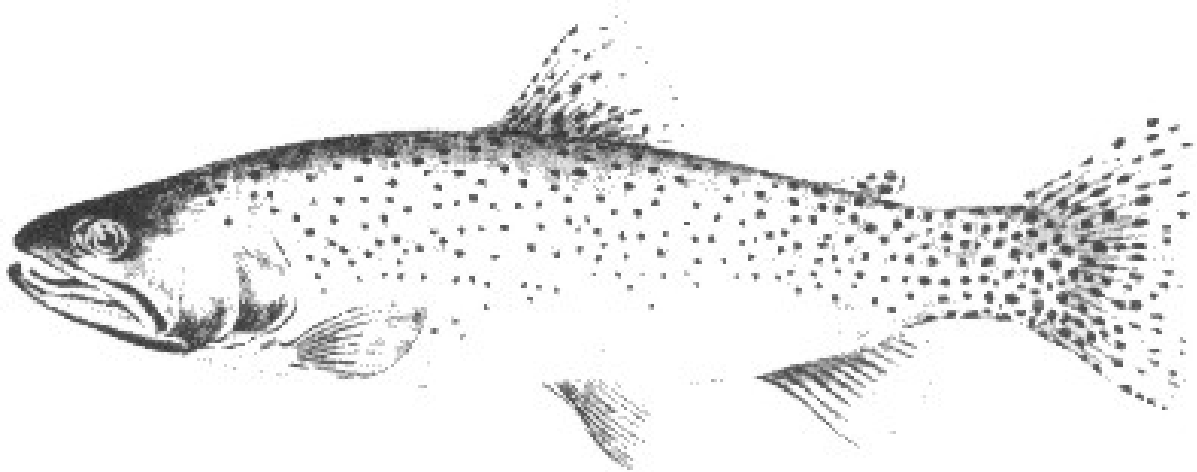

Lahontan cutthroat trout are native to the Truckee, Walker, and Carson River drainages on the east side of the Sierra Nevada in California. Their close relative in California, the Paiute cutthroat trout has a more restricted distribution on the east side of the Sierra Nevada range. These fish are a federally designated threatened species. Resident cutthroat trout are cold water spring spawners. The range of Lahontan cutthroat trout has been expanded by hatchery programs, but is generally limited to higher elevation streams and lakes.

Golden Trout

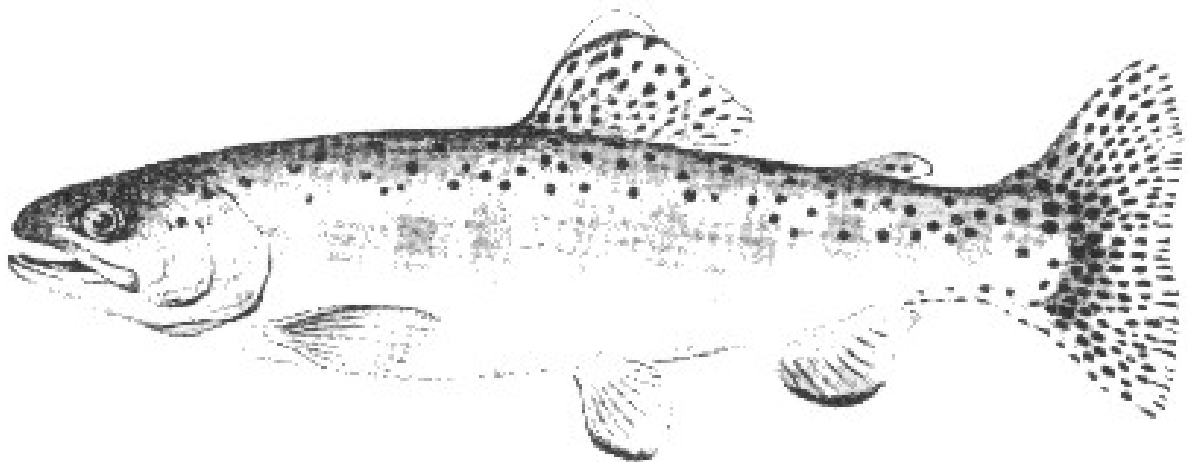

Found native to a few high-elevation streams in the Kern River drainage, this species has been successfully introduced to several other drainages. They are adapted to small, high-elevation waters and provide a specialized recreational opportunity. Spawning occurs in the spring as water temperatures increase in the small high mountain streams. The Little Kern golden trout is a federally threatened species, and the Volcano Creek golden trout is a species of special concern.

CALIFORNIA SALMONID STREAM HABITAT RESTORATION MANUAL

Brook Trout

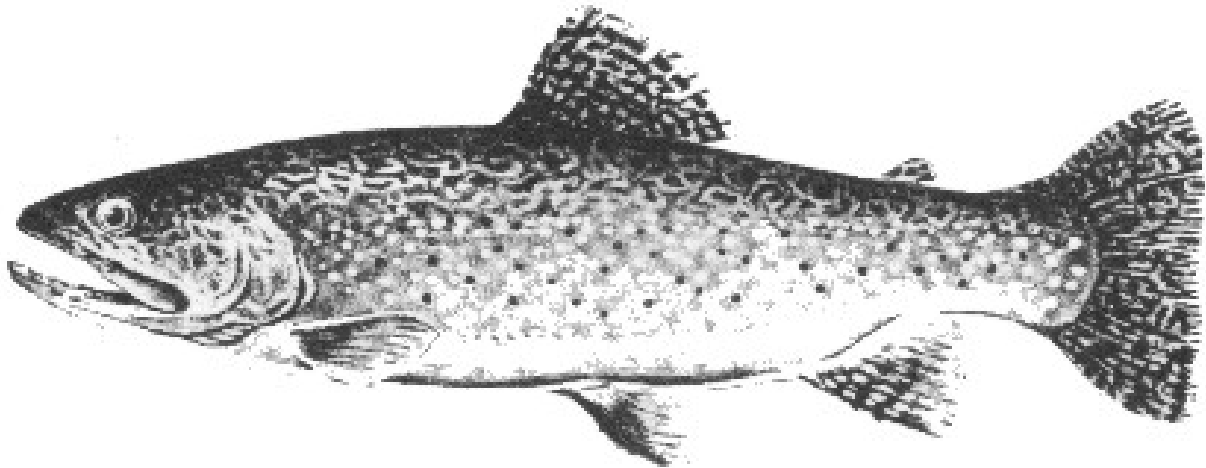

Brook trout, not native to California, have been planted throughout most of the state's trout waters. It is a prolific fall spawner in high-mountain lakes, reservoirs, and streams. Overabundance and stunting have been a recurrent problem in many areas, and hatchery production and planting of brook trout is limited to a few waters where recreational harvest or natural kills control the population.

Brown Trout

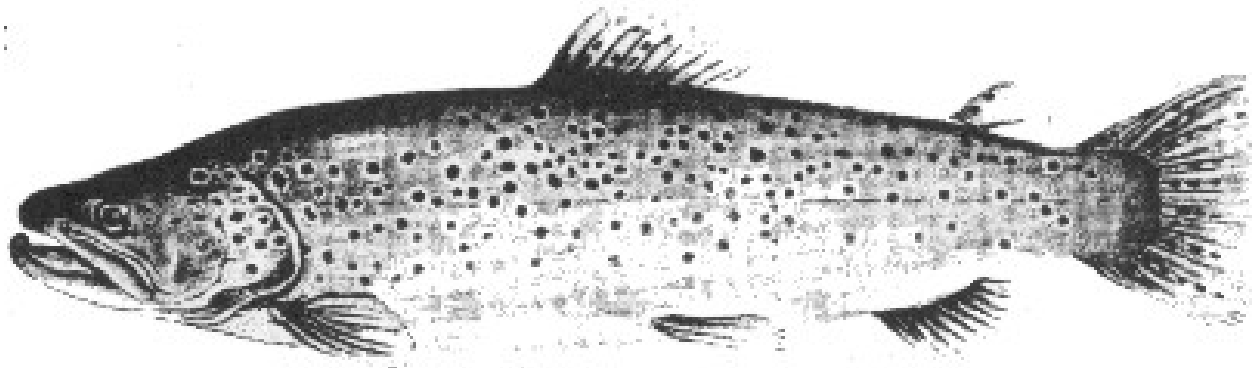

Brown trout, another non-native fish, are widely scattered throughout California as a result of experimental and management planting in most of the state's inland trout waters. They are abundant in only a few areas, and tend to tolerate warmer water (55^E- 60^E Fahrenheit) than rainbow trout. Large brown trout are particularly piscivorous and aggressive, and in warmer waters, tend to out compete other trout species. Spawning occurs in fall and early winter.

**CALIFORNIA SALMONID STREAM
HABITAT RESTORATION MANUAL**

Table P-1. Temperature requirements, degrees Fahrenheit, for various life stages of salmon and steelhead (Reisner and Bjornn, 1979).

Species	Adult migration	Spawning	Incubation	Juvenile rearing
Chinook				
Fall	51 - 67	42 - 57	41 - 58	45 - 58
Spring	38 - 56	42 - 57	41 - 58	57 - 67
Coho	45 - 60	40 - 49	40 - 56	53 - 58
Steelhead	-	39 - 49	-	45 - 58

CALIFORNIA SALMONID STREAM HABITAT RESTORATION MANUAL

REFERENCES

- Barnhart, R.A. 1986. Species profiles: life histories and environmental requirements of coastal fishes and invertebrates (Pacific Southwest) -- Steelhead. U.S. Fish and Wildlife Service. Biol. Rep. 82 (11.60). U.S. Army Corps of Engineers, TR EL-82-4. 21 pp.
- Hassler, Thomas. J., 1987. Species Profiles: life histories and environmental requirements of coastal fishes and invertebrates (Pacific Southwest) -- Coho. U.S. Fish and Wildlife Service Biol. Rep. 82 (11.70). U.S. Army Corps of Engineers, TR EL-82-4. 19 pp.
- Reiser, D.W., T.C. Bjornn. 1979. Habitat requirements of anadromous salmonids. Pages 1-54 *in* W.R. Meehan, ed. Influence of forest and range management on anadromous fish habitat in western America. Pacific N.W. Forest and Range Experiment Station. USDA Forest Service, Portland. General Technical Report, PNW-96.

CALIFORNIA SALMONID STREAM HABITAT RESTORATION MANUAL

APPENDIX Q.

GLOSSARY

Acronyms and Abbreviations:

A _{FP}	-	Flood-Prone Area
BLM	-	U.S. Bureau of Land Management
BY	-	Brood Year
CALTRANS	-	California Department of Transportation
CCC	-	California Conservation Corps
CDF	-	California Department of Forestry
cfs	-	Cubic feet per second
CEQA	-	California Environmental Quality Act
CESA	-	California Endangered Species Act
CMP	-	Corrugated Metal Pipe
CPOM	-	Course Particulate Organic Matter
CWT	-	Coded-Wire Tag
d _{bkf}	-	Bankfull Depth
DO	-	Dissolved Oxygen
DOC	-	Dissolved Organic Carbon
DOD	-	Department of Defense
DOM	-	Dissolved Organic Matter
DFG	-	Department of Fish and Game
DWR	-	Department of Water Resources
ELP	-	Environmental License Plate
EPA	-	Environmental Protection Agency
ESA	-	Endangered Species Act of 1973 (Federal)
ESD	-	Environmental Services Division, DFG
FPOM	-	Fine Particulate Organic Matter
FL	-	Fork Length
FY	-	Fiscal Year
GIS	-	Geographic Information System
GPS	-	Global Positioning System
HSA	-	Hydrologic Sub Area
IFD	-	Inland Fisheries Division, DFG
IFIM	-	Instream Flow Incremental Methodology
LDA	-	Log Debris Accumulation
LOD	-	Large Organic Debris
LWD	-	Large Woody Debris
NDDDB	-	Natural Diversity Database
NEPA	-	National Environmental Policy Act
NHD	-	Natural Heritage Division, DFG
NMFS	-	National Marine Fisheries Service

CALIFORNIA SALMONID STREAM HABITAT RESTORATION MANUAL

NOAA	-	National Oceanic and Atmospheric Administration
Q_{bkf}	-	Bankfull Discharge
RRIF	-	Renewable Resources Investment Fund
SB	-	Senate Bill
SCS	-	Soil Conservation Services
SWD	-	Small Woody Debris
TDS	-	Total Dissolved Solids
USBR	-	U.S. Bureau of Reclamation
USCOE	-	U.S. Army Corps of Engineers
USDA	-	U.S. Department of Agriculture
USFS	-	U.S. Forest Service
USFWS	-	U.S. Fish and Wildlife Service
USGS	-	U.S. Geological Survey
W_{bkf}	-	Bankfull Width
W_{FP}	-	Flood-Prone Width
WLPZ	-	Watercourse and Lake Protection Zone
WUA	-	Weighted Usable Area
YOY	-	Young-of-Year

Abstraction: a) The long-term to permanent removal of surface flow from the channel; b) A simple type of stream capture.

Accretion: a) A process of accumulation by flowing water, whether of silt, sand, pebbles, etc.; b) Channel-flow; the gradual increase in the flow of a stream due to influent seepage.

Aggradation: The geologic process by which stream beds, floodplains, and the bottoms of other water bodies are raised in elevation by the deposition of material eroded and transported from other areas. It is the opposite of degradation.

Alkalinity: A measure of the power of a solution to neutralize hydrogen ions (H^+) usually expressed as mg/l $CaCO_3$.

Alluvial stream: Named after the silts, clays, sands, and gravels of river origin that compose their bed, banks, and floodplains, alluvial streams are characterized by a distinctive S-shaped channel pattern that is free to shift slowly (meander) in the valley. Repeated bank cavings do not widen the channel as they do in erodible bed streams. Alluvial streams have their bed materials conveyed from upstream, and they tend to be large.

Alluvium: A general term for all deposits resulting directly or indirectly from the sediment transport of streams, thus including the sediments laid down in riverbeds, floodplains, lakes, fans and estuaries.

Anchor ice: Ice formed below the surface of a stream, on the stream bed or upon a submerged body or structure.

CALIFORNIA SALMONID STREAM HABITAT RESTORATION MANUAL

Apparent velocity: The rate of flow of subsurface water through the substrate, expressed as the volume of water flowing per unit of time through a unit area (of solids plus voids). Also called interstitial velocity.

Armoring: a) The formation of an erosion-resistant layer of relatively large particles on the surface of the stream bed which resists degradation by water currents, resulting from removal of finer particles by erosion; b) The application of various materials to protect stream banks from erosion.

Attribute: See Habitat component.

Bank: See Stream bank.

Bank storage: Infiltration of water into stream bank material during periods of high flow.

Bankfull discharge: The discharge corresponding to the stage at which the flood plain of a particular stream reach begins to be flooded. The point at which bank overflow begins.

Bankfull stage: Corresponds to the discharge at which channel maintenance is most effective, that is, the discharge at which moving sediment, forming or removing bars, forming or changing bends and meanders, and generally doing work that results in the average morphologic characteristics of channels. The bankfull stage is the most effective or is the dominate channel-forming flow, and has a recurrence interval of 1.5 years. (Dunne & Leopold, 1978).

Bar: a) A ridge-like accumulation of sand, gravel, or other alluvium material formed in the channel, along the banks, or at the mouth of a stream where a decrease in velocity induces deposition; b) An alluvial deposit of sand, gravel, or other material, at the mouth of the stream or at any point in the stream itself which obstructs flow and induces depositions. Chamberlain (1980) gives a description of bar types as follows:

braiding - pattern of river bars with numerous interconnected small channels.

diamond/braiding - multiple diamond-shaped interconnected mid-channel bars characteristic of braided rivers.

dunes - wave-like bed form common in relatively active sand bed channels.

islands - bars or land segments within the stream channel that are relatively stable, usually vegetated, and normally surrounded by water.

junction bar - a bar formed at the junction of two streams, usually because sediment transported by a tributary is deposited in the slower-moving water of the main stream.

lee bar - a bar caused by eddies and lower current velocities and formed in the lee of large immovable objects such as boulders or logs.

CALIFORNIA SALMONID STREAM HABITAT RESTORATION MANUAL

mid-channel bar - bar found in the mid-channel zone, not extending completely across the channel.

point bar - bar found on the island of meander bends.

side bar - bar located at the side of a river channel, usually associated with the inside of slight curves.

transverse bar - bar that extends diagonally across the full width of the active stream channel.

Basin: See Drainage area.

Beaded Stream: A stream consisting of a series of small pools or lakes connected by short stream segments; eg., a stream commonly found in a region of paternoster lakes or an area underlain by permafrost.

Bedload: Sediment moving on or near the stream bed and frequently in contact with it.

Bedload discharge: The quantity of bed load passing a given point in a unit of time, expressed as dry weight.

Bed roughness: A measure of the irregularity of stream bed materials as they contribute to resistance to flow. Commonly measured in terms of Manning's roughness coefficient.

Benthos: Organisms living on or within a stream's substrate.

Berm: A levee, shelf, ledge or bench along a stream bank that may extend laterally into the channel to partially obstruct the flow, or parallel to the flow to contain the flow within its stream banks. May be natural or man-made.

Biomass: a) The weight of a taxon or taxa per unit of stream surface; b) Amount of substance in a population, expressed in material units, such as living or wet weight, dry weight, ash-free weight, nitrogen content, etc.; also called standing crop.

Bog: A wetland comprised of in-situ accumulations of poorly to moderately decomposed peat that are derived chiefly from sphagnum mosses. The water is acidic.

Bole: See large organic debris.

Boulder: Stream substrate particle larger than 256 mm (10 inches) in diameter. See Substrate particle size table.

Braided: A stream that divides into a interlacing or tangled network of several branching and reunited channels separated from each other by branch islands or channel bars.

CALIFORNIA SALMONID STREAM HABITAT RESTORATION MANUAL

Buffer strip: Vegetation strip left intact along a stream or lake after logging.

Canopy: The overhead branches and leaves of stream-side vegetation.

Canopy cover: The vegetation that projects over the stream. Can arbitrarily be divided into two levels: **Crown cover** is more than three feet (1 m) above the water surface. **Overhang cover** is less than three feet (1 m) above the water surface.

Canopy density: The percentage of the stream covered by the canopy of plants, sometimes expressed by species.

Carrying capacity: The maximum average number or biomass of organisms or a given species that can be sustained on a long term basis under a given flow regime by a stream or stream reach.

Catchment area: See Drainage area.

Channel: A natural or artificial waterway of perceptible extent that periodically or continuously contains moving water. It has a definite bed and banks which serve to confine the water.

Channelization: Straightening of a stream or the dredging of a new channel to which the stream is diverted.

Channel pattern: The configuration of a stream as seen from above. Described in terms of its relative curvature, it includes:

straight: Very little curvature within the reach.

sinuous: Slight curvature within a belt of less than approximately two channel widths.

irregular: No repeatable pattern.

irregular meander: A repeated pattern vaguely present in the channel plan. The angle between the channel and the general valley trend is less than 90 degrees.

regular meander: Characterized by a clearly repeated pattern.

tortuous meander: A more or less repeated pattern characterized by angles greater than 90 degrees.

Channel stability: A measure of the resistance of a stream to erosion that determines how well a stream will adjust to and recover from changes in flow or sediment transport.

Channel width: The horizontal distance along a transect line from bank to bank at the high water marks, measured at right angles to the direction of flow. Multiple channel widths are summed to represent total channel width.

CALIFORNIA SALMONID STREAM HABITAT RESTORATION MANUAL

Checkdam: A small dam designed to retard the flow of water and sediment in a channel, used especially for controlling soil erosion. Also used in channels to divert intragravel water toward surface water for interchange of dissolved gases.

Climatic year: A continuous 12-month period during which a complete annual cycle occurs. The USGS uses the period October 1 to September 30 in the publication of its records of streamflow. Also called a water year.

Cobble: Stream substrate particles between 64 and 256 mm (2.5 and 10 inches) in diameter. Syn: Rubble. See Substrate particle size table.

Colluvium: A general term for loose deposits of soil and rock moved by gravity; e.g. talus.

Community indicators: See Biological indices.

Competence: The maximum size of particle that a stream can carry. This is governed by water velocity.

Conductivity: A measure of the ability of a solution to carry an electrical current dependent on the total concentration of ionized substances dissolved in the water.

Consumptive use of water: Occurs when water is taken from a stream and not returned.

Cover: Anything that provides protection from predators or ameliorates adverse conditions of streamflow and/or seasonal changes in metabolic costs. May be instream cover, turbulence, and/or overhead cover, and may be for the purpose of escape, feeding, hiding, or resting.

Cross-sectional area: The area of a stream, channel, or waterway opening, usually taken perpendicular to the stream centerline.

Debris: Material scattered about or accumulated by either natural processes or human influences.

Debris jam: Log jam. Accumulation of logs and other organic debris.

Debris loading: The quantity of debris located within a specific reach of stream channel, due to natural processes or human activities.

Degradation: The geologic process by which stream beds and flood plains are lowered in elevation by the removal of material. It is the opposite of aggradation.

Dendric: Channel pattern of streams with tributaries that branch to form a tree-like pattern.

Density: Number of individuals per unit area/unit volume.

CALIFORNIA SALMONID STREAM HABITAT RESTORATION MANUAL

Deposition: The settlement or accumulation of material out of the water column and onto the stream bed. Occurs when the energy of flowing water is unable to support the load of suspended sediment.

Depth: The vertical distance from the water surface to the stream bed.

Detritus: a) A non-dissolved product of disintegration or wearing away. Pertains to organic or inorganic matter; b) A collective term for loose rock or mineral matter that is worn off or removed directly by mechanical means; especially fragmental material such as sand, silt, and clay, moved from place of origin.

Discharge: Volume of water flowing in a given stream at a given place and within a given period of time, usually expressed as cubic meters per second (m³/sec), or cubic feet per second (cfs).

Dissolved oxygen: The concentration of oxygen dissolved in water, expressed in mg/l or as percent saturation, where saturation is the maximum amount of oxygen that can theoretically be dissolved in water at a give altitude and temperature.

Diversion: A temporal removal of surface flow from the channel.

Diversity index: The relationship of the number of taxa (richness) to the number of individuals per taxon (abundance) for a given community. See Habitat quality index.

Dominant discharge: The cycle of rising and falling flows in the vicinity of bankfull flows, sustained over a long enough period that it alters a natural channel by dislodging, transporting, and distributing bed materials.

Drainage area: Total land area draining to any point in a stream, as measured on a map, aerial photo or other horizontal plane. Also called catchment area, watershed, and basin.

Drainage density: The relative density of natural drainage channels in a given area, expressed as r miles (or kilometers) of stream channel per square mile (or square kilometer) of drainage area. Syn: stream density.

Drift: a) Voluntary or accidental dislodgement of aquatic invertebrates from the stream bottom into the water column where they move or float with the current; b) Any detrital material transported in the water current.

Eddy: A circular current of water, sometimes quite strong, diverging from an initially flowing contrary to the main current. It is usually formed at a point at which the flow passes some obstruction or on the inside of river bends. Often forms backwater pools or pocket water in riffles.

Embeddedness: The degree that larger particles (boulders, rubble, or gravel) are surrounded or covered by fine sediment. Usually measured in classes according to percentage of coverage of larger particles by fine sediments.

CALIFORNIA SALMONID STREAM HABITAT RESTORATION MANUAL

Ephemeral stream: See Stream, Ephemeral.

Fall: a) A free fall or precipitous descent of water. The plural, falls, may apply to a single waterfall or to a series of waterfalls; b) A very fast white water cascade.

Fen: Peat land fed by relatively fast moving, nutrient-rich water. Water usually neutral to basic and rich in calcium. The peat is mainly made up of decaying sedges and rushes.

Fill: a) The localized deposition of material eroded and transported from other areas, resulting in a change in bed elevation. This is the opposite of scour; b) The deliberate placement of (generally) inorganic materials in a stream, usually along the bank.

Fine sediment: The fine grained particles in stream banks and substrate. These are defined by diameter, varying downward from 0.24 inch (6 mm).

Fish depth: See Fish elevation.

Fish elevation: The elevation of a fish above the stream bed measured at the tip of the fish's snout. See Focal point.

Fish habitat: The aquatic environment and the immediately surrounding terrestrial environment that, combined, afford the necessary biological and physical support systems required by fish species during various life history stages.

Flood: Any flow that exceeds the bankfull capacity of a stream or channel and flows out of the floodplain; greater than bankfull discharge.

Flood level: The elevation of the water surface of a stream during a particular flood.

Floodplain: Any flat, or nearly flat lowland that borders a stream and is covered by its waters at flood stage. Also floodplain, flood-plain.

Flood recurrence interval: See Recurrence interval.

Flow: a) The movement of a stream of water and/or other mobile substances from place to place; b) The movement of water, and the moving water itself; c) The volume of water passing a given point per unit of time. Syn: Discharge.

base flow: The portion of the stream discharge that is derived from natural storage i.e., groundwater outflow and the draining of large lakes and swamps or other source outside the net rainfall that creates surface runoff; discharge sustained in a stream channel, not as a result of direct runoff and without the effects of regulation, diversion, or other works of man. Also called sustaining, normal, ordinary of groundwater flow.

CALIFORNIA SALMONID STREAM HABITAT RESTORATION MANUAL

duration flow: A curve which expresses the relation of all the units of some item such as head, flow, etc., arranged in order of magnitude along the ordinate, and time, frequently expressed in percentage, along the abscissa. A graphical representation of the number of times given quantities are equaled or exceeded during certain periods of record.

enhancement flow: An improvement of flow that provides improvement over natural conditions for the aquatic, terrestrial, and other recreation resources. See improvement flow.

flushing flow: That discharge (natural or human-caused) of sufficient magnitude and duration to scour and remove fines from the stream bed gravel to maintain intragravel permeability.

improvement flow: That discharge which will improve upon existing aquatic organisms and/or related recreational activity by correcting for water quality deterioration and/or utilization pressures. See enhancement flow.

index flow: The discharge at the time of measurement.

instantaneous flow: That discharge measured by any instant in time, applied to any recommended flow term when modified by the appropriate adjective.

instream flow: Streamflow regime required to satisfy a mixture of conjunctive demands being placed on water while it is in the stream.

instream flow requirements: That amount of water flowing through a stream course needed to sustain instream values at an acceptable level.

interstitial flow: See intergravel flow.

intergravel flow: That portion of the surface water that infiltrates the stream bed and moves through the substrate pores.

laminar flow: The type of flow in a stream of water in which each particle moves in a direction parallel to every particle.

least flow: Negotiated lowest flow in a regulated stream that will sustain an aquatic population at agreed upon levels. The flow may vary seasonally. See **minimum flow**.

low flow: The lowest discharge recorded over a specified period of time. Also called minimum flow.

mean flow: The average discharge at a given stream location, usually expressed in (m³/sec or cfs), computed for the period of record by dividing the total volume of flow by the number of days, months, or years in the specified period.

CALIFORNIA SALMONID STREAM HABITAT RESTORATION MANUAL

minimum flow: a) The lowest discharge recorded over a period of time (preferred definition); b) Negotiated lowest flow in a regulated stream that will sustain an aquatic population at agreed upon levels. This flow may vary seasonally. (This recently developed definition is in conflict with definition (a); to avoid confusion (a) should not be used. A suggested alternative is to apply this definition to the term **least flow**.)

modified flow: The discharge at a given point in a stream resulting from the combined effects of all upstream and at-site operations, diversions, return flows, and consumptive uses.

natural flow: The flow as it occurs under natural unregulated conditions at a given stream location.

optimum flow: The discharge regime that allows for the maximum expression of the carrying capacity of any specified use of the stream. Any flow above or below this flow becomes limiting to the use under consideration.

peak flow: The highest discharge recorded over a period of time. Often thought of in terms of spring snow melt, summer, fall or winter rainy season flow. Also called maximum flow.

regime: a) The condition of a stream with respect to the rate of its average flow as measured by the volume of water passing different cross sections in a specified period of time. In this unspecialized sense, the term is incorrectly used as a synonym of regime; b) The existence in a stream channel of a balance or grade between erosion and deposition over a period of years.

regulated flow: The flow in a stream that has been subjected to regulation by reservoirs, diversions, or other works of man.

return flow: That portion of the water previously diverted from a stream, and subsequently returned to that stream, or to another body of ground or surface water.

seven day/Q 10 (7 day/ 10): That low flow which has occurred for seven consecutive days within a ten year period. A specific critical low flow.

subsurface flow: That portion (part or all) of the water that infiltrates the stream bed and moves horizontally through and below it. It may or may not return to the stream channel at some point downstream.

survival flow: That instantaneous discharge required to prevent death of an aquatic organism in a stream during specified short periods of time (e.g., 7 days) of extremely low flow.

turbulent flow: That type of flow in which any particle of water may move in any direction with respect to any other particle.

uniform flow: A flow in which the velocities are the same in both magnitude and direction from point to point. Uniform flow is possible only in a channel of constant cross section and gradient.

CALIFORNIA SALMONID STREAM HABITAT RESTORATION MANUAL

Fluvial: Pertaining to streams or produced by stream action.

Focal point: the location, and the conditions at that location, occupied by an organism. Microhabitat measurements are thus focal point measurements.

Frazil ice: Fine spicules of ice formed in water too turbulent for the formation of sheet ice. Frazil forms in supercooled water when the air temperature is far below freezing (most often below -8^{E} Centigrade or 18^{E} Fahrenheit).

Fredle index: An index of the quality of spawning gravel obtained by dividing geometric mean diameter of particle size by the sorting coefficient.

Freshet: A rapid temporary rise in the stream discharge and level caused by heavy rains or rapid melting of snow and ice.

Gabion: A wire basket filled with stones, used to stabilize banks. Not recommended for habitat enhancement.

Geometric mean diameter (d_g): A measure of the central tendency of particle size composition of substrate materials sometimes used as an index of the quality of spawning gravels. Also referred to as D50 size.

Graded stream: A geomorphic term used for streams that have apparently achieved, throughout long reaches, a state of practical equilibrium between the rate of sediment transport and the rate of sediment supply. Such a stream is in regimen. Syn: a mature stream.

Gradient: a) The general slope, or rate of the change in vertical elevation per unit of horizontal distance, of the water surface of a flowing stream; b) The rate of change of any characteristic per unit of length.

Gravel: Substrate particle size between 2 and 64 mm (0.08 and 2.5 inches) in diameter. See Substrate particle size table.

Habitat: The place where a population lives and its surroundings, both living and nonliving; includes the provision of life requirements such as food and shelter.

Habitat component: A single element (velocity, depth, cover, etc.) of the habitat or environment in which a fish or other aquatic species or population may live or occur. Syn: Attribute.

Habitat type: A land or aquatic unit, consisting of an aggregation of habitats having equivalent structure, function, and responses to disturbance.

Hardness: The total concentration of calcium and magnesium ions expressed as mg/l calcium carbonate. Syn: Total hardness.

Humus: Partially decomposed organic material found in soil and water.

CALIFORNIA SALMONID STREAM HABITAT RESTORATION MANUAL

Hydraulic control point: The top of an obstruction to which stream flow must rise before passing over, or a point in the stream where the flow is constricted.

Hydraulic gradient: a) The slope of the water surface; b) The drop in pressure head per length in the direction of stream flow.

Hydraulic radius: The cross-sectional area of a stream divided by the wetted perimeter.

Hydraulics: Refers to water, or other liquids, in motion and their action.

Hydrograph: A graph showing, for a given point on a stream, the discharge, stage, velocity, or other property of water with respect to time.

Incident light: Visible light reaching the water surface.

Indicator organisms: Organisms that respond predictably to various environmental changes, and whose presence, or abundance, are used as indicators of environmental conditions. See Water quality indicators.

Instream cover: Areas of shelter in a stream channel that provide aquatic organisms protection from predators or competitors and/or a place in which to rest and conserve energy due to a reduction in the force of the current.

Instream flow requirements: See Flow, instream flow requirements.

Intermittent stream: See Stream.

Interrupted stream: See Stream.

Interstitial velocity: See Apparent velocity.

Kinetic energy: The energy of a body or a system with respect to the motion of the body or of the particles in the system.

Large woody debris: A large piece of relatively stable woody material having a diameter greater than 30 cm (12 inches) and a length greater than 2 m (6 feet) that intrudes into the stream channel. Syn: LOD, large organic debris, log. Specific types of large woody debris include:

affixed logs: Single logs or groups of logs that are firmly embedded, lodged or rooted in a stream channel.

bole - Term referring to the stem or trunk of the tree.

large bole - 10 m (33 feet) or more in length; often in the stream for extended periods.

CALIFORNIA SALMONID STREAM HABITAT RESTORATION MANUAL

small bole - less than 10 m (33 feet), usually sections of bole; seldom stable, usually move downstream on high flows.

deadheads: Logs that are not embedded, lodged, or rooted in the stream channel, but are submerged and close to the surface.

digger log: Log anchored to the stream banks and/or channel bottom in such a way that a scour pool is formed.

free logs: Logs or group of logs that are not embedded, lodged or rooted in the stream channel.

root wad: The root mass of the tree. Syn: butt ends.

snag: a) A standing dead tree; b) Sometimes a submerged fallen tree in large streams. The top of the tree is exposed or only slightly submerged.

sweeper log: Fallen tree whose bole or branches form an obstruction to floating objects.

Types of large organic debris accumulation:

clumps: Accumulations of debris at irregularly spaced intervals along the channel margin, not forming major impediments to flow.

jams: Large accumulations of debris partially or completely blocking the stream channel, creating major obstructions to flow.

scattered: Single pieces of debris at irregularly spaced intervals along the channel.

Least flow: Negotiated lowest flow in a regulated stream that will sustain an aquatic population at agreed upon levels. See Flow, minimum.

Macroinvertebrate: An invertebrate animal (without backbone) large enough to be seen without magnification.

Mainstem: The principal, largest, or dominating stream or channel of any given area or drainage system.

Manning's "n": An empirical coefficient for computing stream bottom roughness used in determining water velocity in stream discharge calculations.

Marsh: A water-saturated, poorly drained wetland area, periodically or permanently inundated to a depth of up to 2 m (6 feet), that supports an extensive cover of emergent, non-woody vegetation, essentially without peat-like accumulations.

CALIFORNIA SALMONID STREAM HABITAT RESTORATION MANUAL

Microhabitat: That specific combination of habitat elements in the locations selected by organisms for specific purposes and/or events. Express the more specific and functional aspects of habitat and cover. Separated from adjoining microhabitats by distinctive physical characteristics such as velocity, depth, cover, etc.

Moveable bed: A stream bed made up of materials readily transportable by the streamflow.

Normal high water: A water level attained commonly during runoff season. Distinguished from extreme high water.

Off channel pond: A pond, not a part of the active channel, but connected to the main stream by a short channel. Generally in old flood terraces, but called wall-based channel ponds when located near the base of a valley wall.

Organic debris: Debris consisting of plant or animal material.

Organic materials:

coarse particulate organic matter (CPOM): Organic material having at least a dimension ranging from 0.04 to 3.9 inch (1 mm to 10 cm) 0.04 to 3.9 in). Technically includes both living and dead material, but often used more specifically to detritus.

dissolved organic matter (DOM) or Dissolved organic carbon (DOC): Organic material having a least dimension smaller than 0.45 micron (Passes through a 0.45 micron filter).

fine particulate organic matter (FPOM): Organic material having a least dimension ranging from 0.45 micron to 0.04 inch (1 mm).

Orientation: An organism's position relative to the direction of stream flow.

Overbank storage: Flow of water out of the stream channel and onto the valley floor floodplain during flood flows.

Overhead cover: Material (organic or inorganic) that provides protection to fish or other aquatic animals from above; generally includes material overhanging the stream less than a particular distance above the water surface. Values less than 0.5 m (1.5 feet) and less than 1 m (3 feet) have been used.

Percent fines: Percentage of fine sediments in substrate samples, expressed as a percentage by weight or volume less than some specified diameter. See Fine sediment.

Perennial stream: See stream.

Periphyton: Algae and associated microorganisms growing attached on any submerged surface.

CALIFORNIA SALMONID STREAM HABITAT RESTORATION MANUAL

Permeability: A measure of the rate of which water can pass through a given substrate. Depends upon composition and degree of compaction of the substrate (usually gravel). The apparent velocity per unit of hydraulic gradient. Units: cm/hr.

pH: A measure of the hydrogen-ion activity in a solution, expressed as the negative \log_{10} of hydrogen ion concentration on a scale of 0 (highly acidic) to 14 (highly basic) with a pH of 7 being neutral.

Ponding: An increase in water surface elevation upstream of a blockage or an obstruction.

Pool feature: The condition or object that characterizes a pool's formation. These include: logs, trees, roots, stumps, brush, debris, channel meanders, sediment, culverts, bridges or other manmade objects, beaver dams, or tunnels.

Pool-riffle ratio: The ratio of the surface area or length of pools to the surface area or length of riffles in a given stream reach, frequently expressed as the relative percentage of each category.

Production: a) The process of producing organic material; b) The quantity of organic material produced.

Productivity: a) Rate of new tissue formation or energy utilization by one or more organisms; b) Capacity or ability of an environmental unit to produce organic material; c) The ability of a population to recruit new members by reproduction.

Profile: A graphical presentation of elevation vs distance, as in channel cross sections and longitudinal sections. In open channel hydraulics, it is a plot of water surface elevation against channel distance.

Reach: a) Any specified length of stream; b) A relatively homogeneous section of a stream having a repetitious sequence of physical characteristics and habitat types; c) A regime of hydraulic units whose overall profile is different from another reach.

representative reach: A length of stream which represents a large section of the stream with respect to area, depth, discharge, and slope.

specific reach: A length of channel uniform with respect to selected habitat characteristics or elements (discharge, depth, area, slope, population of hydraulic units), fish species composition, water quality, and type and condition of bank cover.

Recurrence interval: Expected or observed time intervals between hydrological events of a particular magnitude described by stochastic or probabilistic models (log-log plots).

Regime: See Flow, regime.

Revetment: See Riprap.

CALIFORNIA SALMONID STREAM HABITAT RESTORATION MANUAL

Rill: One of the first and smallest channels formed by surface runoff.

Riparian: Pertaining to anything connected with or immediately adjacent to the banks of a stream or other body of water.

Riparian vegetation: Vegetation growing on or near the banks of a stream or other body of water on soils that exhibit some wetness characteristics during some portion of the growing season.

Riparian vegetation erosion control rating: A system for ranking the relative effectiveness of riparian vegetation for controlling bank erosion (Platts et al. 1983).

Riparian area: The area between a stream or other body of water and the adjacent upland identified by soil characteristics and distinctive vegetation. It includes wetlands and those portions of floodplains and valley bottoms that support riparian vegetation.

Riprap: A layer of large, durable materials (usually rock) used to protect a stream bank from erosion. May also refer to the materials themselves. Syn: revetment.

Rock-fill dam: A dam composed of large, broken, and loosely placed or pervious rocks with either an impervious core or upstream facing or surface layer.

Roughness coefficient: See Manning's "n".

Rubble: Stream substrate particles between 64 and 256 mm (2.5 and 10 inches) in diameter. Syn: cobble.

Scour: The localized removal of material from the stream bed by flowing water. This is the opposite of fill.

Sediment: Fragmental material that originates from weathering of rocks and decomposition of organic material that is transported by, suspended in, and eventually deposited by water or air, or is accumulated in beds by other natural phenomena.

Sediment discharge: The mass or volume of sediment (usually mass) passing a stream transect in a unit of time. The term may be qualified, for example, as suspended-sediment discharge, bedload discharge, or total-sediment discharge, usually expressed as tons per day.

Sediment load: The portion of the total sediment load that moves in suspension, free from contact with the stream bed, and is made up of particles having such density or grain size as to permit movement disassociated from the stream bed. Density and grain size vary according to the amount of turbulence. Only unusually swift streams are turbulent enough to lift particles larger than medium-sized sand from their beds. See Bedload.

Seep: An area of minor ground water outflow onto the land surface or into a stream channel. Flows are too small to be a spring.

CALIFORNIA SALMONID STREAM HABITAT RESTORATION MANUAL

Sinuosity: a) The ratio of channel length between two points on a channel to the straight line distance between the same two points; b) The ratio of channel length to down valley length. Channels with sinuosities of 1.5 or more are called "meandering".

Slack water: A quiet part of, or a still body of water in, a stream; e.g., on the inside of a bend, where the current is slight.

Slough: a) Low, swampy ground or overflow channels where water flows sluggishly for considerable distances; b) Side channel slough formed by channelization; c) A sluggish channel of water, such as a side channel of a stream, in which water flows slowly through low, swampy ground, or a section of an abandoned stream channel containing water most or all of the year, but with flow only at high water, and occurring in a floodplain or delta; d) A marsh tract lying in a shallow, undrained depression on a piece of dry ground; e) A term used for a creek or sluggish body of water in a bottom-land.

Solar radiation: Electromagnetic energy from the sun in all wavelengths.

arc of the sun: The distance the sun travels on any given day in degrees from when it first strikes the water until it leaves the water. The arc of the sun on August 1st is used as a standard.

direct solar radiation: Radiation that reaches the water surface in an unobstructed straight line.

reflected solar radiation: Radiation that does not penetrate the water surface, but is redirected away from that surface.

total solar radiation: The sum of direct, reflected and refracted radiation reaching any one point.

Sorting coefficient: A measure of the distribution or variability of particle sizes in the substrate. The usual measure, computed as d_{75}/d_{25} is equivalent to the standard deviation of the log transformed frequency curve, hence a measure of dispersion of particle sizes. A substrate with a large sorting coefficient is termed "well sorted". The terms d_{75} and d_{25} are those diameters for which 75 percent and 25 percent of the cumulative size-frequency distributions are larger.

Specific reach: See Reach.

Spring creek: A stream that derives most of its flow from ground water, with relatively constant flow and temperature.

Stability rating: An index of the resistance or susceptibility of the stream channel and banks to erosion (Platts et al. 1983).

Stage: The elevation of a water surface above or below an established datum or reference.

CALIFORNIA SALMONID STREAM HABITAT RESTORATION MANUAL

Standing crop: The abundance, total weight or energy content of organisms existing in an area at a given time. See Biomass.

Standing stock: The number of organisms (usually fish) present in an area at a particular time. Smaller sizes not susceptible to capture may sometimes be excluded.

Stream: (includes creeks and rivers): A stream is a body of water that flows at least periodically or intermittently through a bed or channel having banks and supports fish or other aquatic life. This includes watercourses having a surface or subsurface flow that supports or has supported riparian vegetation. Streams in natural channels may be classified as follows:

a) Relation to time:

ephemeral: One that flows briefly only in a direct response to precipitation in the immediate locality and whose channel is at all times above the water table.

intermittent or seasonal: One in contact with the ground water table that flows only at certain times of the year as when the ground water table is high and/or when it receives water from springs or from some surface source such as melting snow in mountainous areas. It ceases to flow above the stream bed when losses from evaporation or seepage exceed the available streamflow.

perennial: One that flows continuously throughout the year. Syn: Permanent streams.

b) Relation to space:

continuous: One that does not have interruptions in space.

interrupted: One that contains alternating reaches that are either perennial, intermittent, or ephemeral.

c) Relation to ground water:

insulated: A stream or reach of a stream that neither contributes to nor receives water from the zone of saturation. It is separated from the zones of saturation by an impermeable bed.

gaining: A stream or reach of stream that receives water from the zone of saturation.

losing: A stream or reach of stream that contributes water to the zone of saturation.

perched: Either a losing stream or a insulated stream that is separated from the underlying ground water by a zone of aeration.

d) Other:

incised: A stream that has, through degradation, cut its channel into the bed of the valley.

Stream bank: The portion of the channel cross section that restricts lateral movement of water at normal water levels. The bank often has a gradient steeper than 45 degrees and exhibits a distinct

CALIFORNIA SALMONID STREAM HABITAT RESTORATION MANUAL

break in slope from the stream bottom. An obvious change in substrate may be a reliable delineation of the bank.

lower bank: The periodically submerged portion of the channel cross section from the normal high water line to the water's edge during the summer flow period.

upper bank: That portion of the topographic cross section from the break in the general slope of the surrounding land to the normal high water line.

Stream capacity: Total volume of water that a stream can carry within the normal high water channel. Also called stream bottom.

Stream classification: Various systems of grouping or identifying streams possessing similar features according to geomorphic structure (e.g., gradient), water source (e.g., spring creek), associated biota (e.g., trout zone) or other characteristics. A hierarchical classification.

Stream corridor: A stream corridor is usually defined by geomorphic formation, with the corridor occupying the continuous low profile of the valley. The corridor contains a perennial, intermittent, or ephemeral stream and adjacent vegetative fringe.

Stream density: Kilometers of stream per square kilometer or area. Syn: Drainage density.

Stream/estuary ecotone: An area near the stream mouth extending from the upper limit of tidal influence seaward to the lower limit of marsh vegetation. Its size depends on stream gradient and range of tidal heights.

Stream flow: See Flow (a).

Stream/forest ecotone: An area of the stream directly influenced by riparian vegetation, including the stream bank and upland area adjacent to the stream. Its size depends on the stream width, type of vegetation, and the physical characteristics of the adjoining uplands.

Stream frequency: The number of streams per square kilometer of area.

Stream order: The designations (1, 2, 3, etc.) of the relative position of stream segments in a drainage basin network: The smallest, unbranched, perennial tributaries, terminating at an outer point, are designated order 1; the junction of two first-order streams produces a stream segment of order 2; the junction of two second-order streams produces a stream segment of order 3, etc. Use of small-scale maps (<2 in/mile) may cause smaller streams to be overlooked, leading to gross errors in designation. Ideally, designations should be determined on the ground or from large-scale air photos.

Stream pattern: See Channel pattern.

Stream power: The rate of doing work, or a measure of the energy available for moving rock, sediment particles, or woody or other debris in the stream channel, as determined by discharge, water surface slope, and the specific weight of water.

CALIFORNIA SALMONID STREAM HABITAT RESTORATION MANUAL

Stream reach: A portion of a stream that is relatively homogeneous based on geomorphology, stream flow, geology, and sinuosity. It is frequently bounded by significant tributaries, diversions, reservoirs, etc. It also may be thought of as a series of short reaches with common morphology.

Stream shore water depth: The water depth at the stream shoreline or at the edge of a bank overhanging the shoreline. This depth could be greater than 0 if the bank is undercut.

Stream width: See wetted width.

Structure: a) Any object, usually large, in the stream channel that controls water movement; b) The diversity of physical habitat within a stream; c) When applied to a biological community, the organization of taxa into various functional or trophic groups.

Substrate: The mineral and/or organic material that forms the bed of the stream.

Suspended sediment: See Suspended load.

Swamp: Tree or tall shrub dominated wetlands that are characterized by periodic flooding and nearly permanent subsurface water flow through mixtures of mineral sediments and organic materials, essentially without peat-like accumulation.

Swimming speed: Swimming speeds of stream fish vary from essentially zero to over 19.7 feet per second (six meters per second), depending upon species, size and activity. Three categories of performance are generally recognized.

cruising speed: The speed that a fish can maintain for an extended period of time without fatigue. This implies a lack of stress, and is the maximum speed traveled by undisturbed individuals.

sustained (prolonged) speed: The speed that a fish can maintain for a prolonged period, but which ultimately results in fatigue. At this speed the fish is under some degree of stress.

burst (darting) speed: The speed that a fish can maintain for a very short time, generally 5-10 seconds, without gross variation in performance. Burst speed would be employed for feeding or escape, and represents maximum swimming speed.

Thalweg: The line connecting the lowest or deepest points along a stream bed.

Torrent: A temporary flow condition in streams created by heavy rainfall or rapid snow melt; characterized by near bankfull discharge, sizable increase in velocity, standing waves, and loss of the typical stepped profile and hydraulic diversity of habitat.

Total dissolved solids (TDS): A measure of inorganic and organic materials dissolved in water (passing through a 0.45 micron filter); often referred to as Filterable Residue (FR) and expressed as mg/l FR. Sometimes considered similar to conductivity as an indicator of potential production in habitat quality indices.

Total suspended solids: The organic and inorganic material left on a standard glass fiber filter

CALIFORNIA SALMONID STREAM HABITAT RESTORATION MANUAL

(0.45 micron) after a water sample is filtered through it; often referred to as Non-Filterable Residue (NFR).

Trash collector dam: A fence-like structure or grillwork of heavy wire, metal or logs placed across a stream to intercept and hold debris flowing downstream, creating a dam or blockage. Used to protect bridge crossings, create pools, and store gravel for spawning habitat. Syn: Debris catcher, grizzly.

Tributary: A stream feeding, joining, or flowing into a larger stream. Syn: Feeder stream, side stream. Tributary types based on watershed geomorphology include:

lower valley wall tributaries: Characterized by moderately steep gradients and occur at the slope break between the valley wall and valley floor.

terrace tributaries: Results from spring networks on valley floor, and from tributaries draining valley side slopes and continuing across terraces to the main stream.

upper valley wall tributaries: Possess very steep gradients, high velocities, and flow over a stepped profile of alternating pools and cascades.

upper valley wall tributaries: Run along the base of the valley wall, parallel to the main stream channel.

wall based tributaries: Run along the base of the valley wall, parallel to the main stream channel.

Turbidity: a) Relative water clarity; b) A measurement of the extent to which light passing through water is reduced due to suspended materials. Measured by several non-equivalent standards (e.g., Nephelometric Turbidity Units, NTU; Formazin Turbidity Units, FTU; Jackson Turbidity Units, JTU).

Turbulence: The motion of water where local velocities fluctuate and the direction of flow changes abruptly and frequently at any particular location, resulting in disruption of laminar flow. It causes surface disturbance and uneven surface level, and often masks subsurface areas because air bubbles are entrained in the water.

Undercut bank: A bank that has had its base cut away by the water action along man-made and natural overhangs in the stream.

Vegetative fish cover: Vegetation materials such as algal mats and organic debris capable of providing protection for fish and other aquatic organisms.

Velocity: The time rate of motion; the distance traveled divided by the time required to travel that distance.

critical velocity: a) The maximum swimming speed that a fish can sustain over a specified distance or length of time, or the maximum water velocity against which a fish can sustain a

CALIFORNIA SALMONID STREAM HABITAT RESTORATION MANUAL

position over a specified length of time; b) The velocity in a channel at which flow changes from laminar to turbulent; c) Velocity through which a fish will not swim, creating a velocity barrier.

fish velocity or focal point velocity: Represents the velocity at the location occupied by a fish, measured at the fish's snout. Syn: Snout velocity, facing velocity.

mean column velocity: The average velocity of the water measured on an imaginary vertical line at any point in a stream. A measurement at 60 percent of the depth, measured from the surface, closely approximates the average velocity for the water column. In water greater than 76 cm (30 in) in depth, the average of measurements made at 20 percent and 80 percent of the depth approximates the mean column velocity.

mean cross sectional velocity: Represents the mean velocity of water flowing in a channel at a given cross-section. It is equal to the discharge divided by the cross-section area of the cross section.

profile: A curve representing the velocity of flow along a given line.

swimming velocity: See Swimming speed.

thalweg velocity: The mean column velocity at the thalweg.

V-notch: a) Narrow, steep-sided ravine or valley with V-shaped cross-section whose bottom usually contains a watercourse; b) A type of weir containing a V-shaped notch used for gauging discharge in small streams.

Wash load: The load that because of its fine size has such a small settling velocity that it would be held in suspension. It is essentially synonymous with suspended load.

Water width: See Wetted width.

Water year: See Climatic year

Water yield: The total outflow from all or part of a drainage basin through either surface channels or subsurface aquifers within a given time (e.g., one year).

Watershed: See Drainage area.

Weighted Usable Area (WUA): a) An index of the capacity of a stream reach to support the species and life stage being considered, expressed as actual area or percentage of habitat area predicted to be available per unit length of stream at a given flow; b) The total surface area having a certain combination of hydraulic and substrate conditions, multiplied by the composite probability of use by fish for the combination of conditions at a given flow.

Weir: a) A notch or depression in a levee, dam, embankment, or other barrier across or bordering a stream, through which the flow of water is measured or regulated; b) A barrier constructed across a stream to divert fish into a trap; c) A dam (usually small) in a stream to raise the water level or divert its flow.

CALIFORNIA SALMONID STREAM HABITAT RESTORATION MANUAL

Wetland: An area subjected to periodic inundation, usually with soil and vegetative characteristics that separate it from adjoining non-inundated areas.

Wetted perimeter: The length of the wetted contact between a stream of flowing water and the stream bottom in a vertical plane at right angles to the direction of flow.

Wetted width: The width of the water surface measured at right angles to the direction of flow and at a specific discharge. Widths of multiple channels are summed to represent total wetted width.

White water: Occurs where flows are sufficiently fast and turbulent to entrain air bubbles in the water.

Woody Debris: See Large woody debris.

CALIFORNIA SALMONID STREAM HABITAT RESTORATION MANUAL

REFERENCES

- Chamberlain, T.W. 1980. Aquatic survey terminology. British Columbia Ministry of Environment, Assessment and Planning Division, Technical Paper No. 2, Victoria, British Columbia.
- Dunne, T. and L.B. Leopold. 1978. Water in Environmental Planning. W.H. Freeman and Co., San Francisco, CA, 818 p.
- Helm, William T., ed. 1985. Glossary of stream habitat terms. Western Division, American Fisheries Society. USA.
- Platts, W.S., D. Armour, G.D. Booth, M. Gryant, J.L. Bufford, P. Cuplin, S. Jensen, G. W. Lienkaemper, G.W. Minshall, S.B. Monsen, R.L. Nelson, J.R. Sedell, and J.S. Tuhy. 1987. Methods For Evaluating Riparian Habitats With Applications To Management.
- United States Department of Agriculture, Forest Service General Technology Report INT 221 U.S. Department of Agriculture, Forest Service. February 1990. Fish habitat assessment handbook. USFS, Region 5 FHS 2609.23, Draft Copy.

**CALIFORNIA SALMONID STREAM
HABITAT RESTORATION MANUAL**

APPENDIX R.

FORMS

WATERSHED OVERVIEW WORK SHEET

Date _____/_____/_____ Investigator _____
Stream Name _____ PNMCD _____
Tributary to _____ Tributary to _____
Tributary to _____ Tributary to _____
County _____ USGS Quad _____

Location T ____ R ____ S ____ Latitude _____ Longitude _____

Access Via _____

Hydrologic Boundary Delineation _____

Aerial Photos (Source) _____

Stream Order _____ Total Length _____ miles

Drainage Area _____ sq. mi. Summer Base Flow _____ cfs

Elevations Mouth _____ feet Headwaters _____ feet

Lakes in Watershed Number _____ Surface Area _____ sq. mi.

Fish Species (Data Source) _____,
_____, _____,
_____, _____

Endangered / Threatened / Sensitive Species (Data Source)
_____, _____

Endemic Stocks (Data Source) _____

Fishery Management Concept Cold Water: Natural Production _____
Mixed Production _____
Anadromous: Natural Production _____
Mixed Production _____
Warm Water: _____
Other: _____

Stream Flow Data (Source) _____

Water Quality Data (Source) _____

Ownerships in Stream Mi. Federal _____ State _____ Private _____
Additional Information _____

Major Land Uses in the Watershed: _____, _____, _____, _____,
Additional Information _____

Comments _____

STREAM CHANNEL TYPE WORK SHEET

Form # ____ of ____

Channel Type _____ Channel Change Location (Habitat Unit#) _____
 Cross-Section Location (Habitat Unit#) _____ Date ____/____/____
 Stream _____
 T _____ R _____ S _____ Surveyors _____
 Quad _____ Lat _____ Long _____

Single Thread Channel _____ (Y/N) Multiple Channel _____ (Y/N)

Bankfull Width (W_{bkf}) = _____ (ft.)

Transect Recording Box

Dist.																				
Depth																				
Sub.																				

Sum of Depths _____

Dominant Substrate Determination:

- | | | | |
|----|----------------------|---------------|-----------------------------------|
| | <u>Substrate:</u> | <u>Number</u> | |
| 1. | Bedrock | = _____ | (Circle Most Frequent Occurrence) |
| 2. | Boulder (>10") | = _____ | |
| 3. | Cobble (2.5 - 10") | = _____ | |
| 4. | Gravel (0.08 - 2.5") | = _____ | |
| 5. | Sand (<0.08) | = _____ | |
| 6. | Silt / Clay | = _____ | |

Entrenchment Determination:

- Step 1: Maximum Bankfull Depth _____ x 2 = _____ (W_{FP} Elev.)
- Step 2: Determine Flood-Prone Width at WFP Elevation = _____ (W_{FP})
- Step 3: Flood-Prone Width (W_{FP}) / Bankfull Width (W_{bkf}) = Entrenchment
 W_{FP} _____ (ft.) / _____ (ft.) = _____ (**Entrenchment**)

Width/Depth Determination:

- Step 1: Sum of Depths _____ / No. Depths _____ = Mean Bankfull Depth (d_{bkf}) _____
- Step 2: Bankfull Width (W_{bkf}) / Mean Bankfull Depth (d_{bkf}) = Width/Depth Ratio
 W_{bkf} _____ (ft.) / d_{bkf} _____ (ft.) = _____ (**W/D Ratio**)

Sinuosity Determination (Only For A or G Types):

Stream Length _____ / Valley Length _____ = Sinuosity _____

Water surface slope Determination:

Downstream Level - Upstream Level _____ / Distance (D) = Energy Gradient
 DSL _____ (ft.) - USL _____ (ft.) / (D) _____ (ft.) = _____

HABITAT INVENTORY DATA FORM										Form #	of	
Date	/	/	Stream Name							T	R	S
Surveyors							Lat.		Lon.			
Quad.			Channel Type			Reach		BFW	@HU#			
Time		H ₂ O F°	Air F°		Flow	Pg Length		Totl. Length				
Habitat Unit Number												
Habitat Unit Type												
Side Channel Type												
Mean Length												
Mean Width												
Mean Depth												
Maximum Depth												
Depth Pool Tail Crest												
Pool Tail Embeddedness												
Pool Tail Substrate												
LWD Count D>1&L6to20												
LWD Count D>1&L>20												
Shelter Rating	Shelter Value											
	% Unit Covered											
	% undercut bank											
	% swd (d<12")											
	% lwd (d>12")											
	% root mass											
	% terr. vegetation											
	% aqua. vegetation											
	% bubble curtain											
	% boulders (d>10")											
% bedrock ledges												
Substrate Composition	2 Most Dominant											
	A) Silt/Clay											
	B) Sand											
	C) Gravel (0.08-2.5")											
	D) Sm Cobble (2.5-5")											
	E) Lg Cobble(5-10")											
	F) Boulder (>10")											
	G) Bedrock											
Percent Exposed Substrate												
PERCENT TOTAL CANOPY												
% Hardwood Trees												
% Coniferous Trees												
Bank Composition & Vegetation	Rt Bk Composition											
	Rt Bk Dominant Veg											
	% Rt Bk Vegetated											
	Lft Bk Composition											
	Lft Bk Dominant Veg											
	% Lft Bk Vegetated											
Bank Composition Types			omments: structures channel diversions Tribs Erosion Biota passage Access GPS othe									
1) Bedrock												
2) Boulder												
3) Cobble/Gravel												
4) Silt/Clay/Sand												
Vegetation Types												
5) Grass												
6) Brush												
7) Deciduous Trees												
8) Evergreen Trees												
9) No Vegetation												

STREAM BANK OR UNDERWATER OBSERVATION FIELD FORM

Form No. _____ of _____ Date ____/____/____

Stream Name _____ T ____ R ____ S ____

Drainage _____

Lat: _____ Long: _____ Quad: _____

Observer(s) _____

Time _____ Air Temperature _____ Water Temperature _____

Reach No. _____ Habitat Unit No. _____ Habitat Type _____

Reference Point _____

Distance from the confluence or other reference point _____

Length of stream sampled in feet _____

Observation Method: _____ Stream Bank _____ Underwater

Species	Size Class	Numbers	Species	Size Class	Numbers

Comments _____

**ELECTROFISHING FIELD FORM
SUPPLEMENTAL PAGE**

Form # _____ of _____

Date ___/___/___ Stream Name _____ Site # ___ Drainage _____ Pass # _____

Start Time _____ **End Time** _____ **Start Water Temp** _____ **End Water Temp** _____

Start Air Temp _____ **End Air Temp** _____

Effort(s) _____ + _____ = **Total Effort (E₂)** _____ (seconds) Freq. _____ (Hz) Output Voltage _____

Species	Fork Length (mm)																		

Summary: Species _____ Catch _____ Wt. _____ Mortalities _____;
 Species _____ Catch _____ Wt. _____ Mortalities _____;
 Species _____ Catch _____ Wt. _____ Mortalities _____;
 Species _____ Catch _____ Wt. _____ Mortalities _____;

Comments:

$$(1 - [(N_2 * E_1) / (N_1 * E_2)]) * 100 = \text{Pass Depletion}$$

$$(1 - [(\quad * \quad) / (\quad * \quad)]) * 100 = \quad \text{Pass \#2 Depletion}$$

Site # _____ Pass # _____

Start Time _____ **End Time** _____ **Start Water Temp** _____ **End Water Temp** _____

Start Air Temp _____ **End Air Temp** _____

Effort(s) _____ + _____ = **Total Effort (E₂)** _____ (seconds) Freq. _____ (Hz) Output Voltage _____

Species	Fork Length (mm)																		

Summary: Species _____ Catch _____ Wt. _____ Mortalities _____;
 Species _____ Catch _____ Wt. _____ Mortalities _____;
 Species _____ Catch _____ Wt. _____ Mortalities _____;
 Species _____ Catch _____ Wt. _____ Mortalities _____;

Comments:

$$(1 - [(N_3 * E_2) / (N_2 * E_3)]) * 100 = \text{Pass Depletion}$$

$$(1 - [(\quad * \quad) / (\quad * \quad)]) * 100 = \quad \text{Pass \#3 Depletion}$$

LWD INVENTORY FORM

Stream: _____ Sample _____ of _____ Reach No. _____

Date ____/____/____ Drainage: _____ USGS Quad: _____

Reference Point: _____ Sample Length (Ft) _____

Reach Location (Feet From Ref.Pt) Start _____ Stop _____ Total _____

Lat ____ N Long ____ W (Reach start or Ref.Pt.) T ____ R ____ S ____

Surveyors: _____

CHANNEL CHARACTERISTICS (Attach Channel Typing Form)

Discharge Q _____ cfs Gradient _____ % Channel Type: _____

Percent Substrate in Boulders: (1'- 3') _____%; (>3') _____%

Air Temp _____ Water Temp _____

	Right Bank				Stream				Left Bank			
	% Slope _____ Dom. Veg. _____				Dom. Veg. _____				% Slope _____ Dom. Veg. _____			
	D/D	D/S	P e r	Live C D	Dead/ Down	D/S	Live C D	D/D	D/S	P e r	Live C D	
1-2d												
6-20												
Root												
1-2d												
>20'												
2-3d												
6-20												
Root												
2-3d												
>20'												
3-4d												
6-20												
Root												
3-4d												
>20'												
>4d												
6-20												
Root												
>4d												
>20'												

Note any LDAs (log jams), estimate size LxWxH and no. pieces. Note if gravel is retained upstream. Tally live conifer "C" and deciduous "D" trees separately. Tally root wads by diameter of "trunk". Include root wads <6' total length.

Comments:

PROJECT SITE COMPLETION FORM

Stream: _____ **Date:** _____ **Page** _____ **of** _____

Contractor/Organization: _____

Inspector: _____ **Contract No.:** _____ **FY:** ____/____

Landowner: _____

Estimated Cost: _____

Length of Project/Numbers of Structures: _____

Reference Point: _____ **Lat:** _____ **Long:** _____

Feet From Reference Point: _____ UP / DN **Channel Type:** _____

Constructed Using: Hand Crew Heavy Equipment Both

Project Objective: Instream Habitat Erosion Control Fish Passage

Type of structure: _____

Project Completion Check Points:	YES	NO	
1. Project techniques according to manual	<input type="checkbox"/>	<input type="checkbox"/>	If no, explain: _____ _____
2. Materials of recommended type and size	<input type="checkbox"/>	<input type="checkbox"/>	If no, explain: _____ _____
3. Structure positioned correctly to meet objectives	<input type="checkbox"/>	<input type="checkbox"/>	If no, explain: _____ _____
4. Followed permit(s) specifications	<input type="checkbox"/>	<input type="checkbox"/>	If no, explain: _____ _____
5. Landowner(s) agreed with work and materials used	<input type="checkbox"/>	<input type="checkbox"/>	If no, explain: _____ _____

Original Habitat Type: _____ **Target Habitat Type:** _____

Habitat Maximum Depth: _____ **ft.** **Bankfull Stream Width:** _____ **ft.**

Comments: _____

If Revegetation: Riparian Upslope Both (photo required for revegetation.)

Describe Density or Coverage: _____

Photographs: Yes No **If yes, location of photographs:** _____

STREAM HABITAT ENHANCEMENT PROJECT EVALUATION

GENERAL PROJECT INFORMATION FORM

STREAM: _____ WATERSHED: _____

EVALUATOR: _____ DATE: _____

CONTRACT NO.: _____ FY: ____/____ FUND SOURCE: _____

DFG CONTACT: _____ CONTRACTOR: _____

DOES THIS CONTRACT INCLUDE OTHER STREAMS OR LOCATIONS: Y ___ N ___

AMOUNT SPENT ON EVALUATED PORTION OF CONTRACT: \$ _____
(May include total contract amount or a portion of contract)

PROPERTY OWNER: _____

ACCESS DIRECTIONS: _____

CHANNEL TYPE(S): _____ STREAM ORDER: _____ DRAINAGE AREA (SQ MI): _____

USGS QUAD (7.5 MIN): _____

PROJECT LOCATION AT DOWNSTREAM END: LAT. _____ LONG. _____

DATE PROJECT COMPLETED: MONTH _____ YEAR _____

DATE OF LAST EVALUATION: MONTH _____ YEAR _____

PRE-PROJECT EVALUATION OR DATA AVAILABLE: Y ___ N ___ IF YES WHERE? _____

ARE AS-BUILT DATA OR PROPOSED DESIGNS AVAILABLE: Y ___ N ___ IF YES WHERE? _____

NO. OF STRUCTURES CONSTRUCTED: _____ NO. OF STRUCTURES EVALUATED: _____

COMMENTS: _____

NUMBER OF EVALUATION PAGES ASSOCIATED WITH THIS FORM: _____

GENERAL PROJECT EVALUATION OR COMMENTS: _____

**STREAM HABITAT ENHANCEMENT PROJECT EVALUATION
INDIVIDUAL STRUCTURE OR SITE FORM**

STREAM: _____ DRAINAGE: _____ PAGE _____ of _____

DATE: ____/____/____ STREAM PNAME: _____ PNAME CODE: _____

EVALUATOR(s): _____ CONTRACT NO.: _____ FY: ____/____

REFERENCE POINT: _____ LAT: _____ LONG: _____
(DECIMAL DEGREES) (DECIMAL DEGREES)

FEET FROM REFERENCE POINT: _____ UP DN CHANNEL TYPE: _____

RESTORATION OBJECTIVE: 1 2 3 TYPE OF STRUCTURE: _____

HOW WELL IS STRUCTURE MEETING HABITAT OBJECTIVE? (circle number)

1 (EXCELLENT) _____ **2 (GOOD)** _____ **3 (FAIR)** _____ **4 (POOR)** _____ **5 (NO VALUE)** _____

COMMENTS: _____

CONDITION OF STRUCTURE - consider structural integrity only (circle number):

1 (EXCELLENT) _____ **2 (GOOD)** _____ **3 (FAIR)** _____ **4 (POOR)** _____ **5 (NO VALUE)** _____

COMMENTS: _____

STRUCTURE PROBLEMS (check appropriate items):

- | | |
|--|---|
| 1. <input type="checkbox"/> ANCHOR FAILURE, | 8. <input type="checkbox"/> LOGS/BOULDERS STRANDED OUT OF CHANNEL, |
| 2. <input type="checkbox"/> CABLE FAILURE, | 9. <input type="checkbox"/> BANK EROSION AT SITE AND/OR DOWNSTREAM, |
| 3. <input type="checkbox"/> CHANNEL SHIFT, | 10. <input type="checkbox"/> CREATED SEDIMENT TRAP, |
| 4. <input type="checkbox"/> BOULDER/LOG SHIFT, | 11. <input type="checkbox"/> POOR DESIGN, |
| 5. <input type="checkbox"/> UNDERMINED, | 12. <input type="checkbox"/> POOR PLACEMENT, |
| 6. <input type="checkbox"/> BURIED BY BEDLOAD, | 13. <input type="checkbox"/> EX-FENCE FAILURE, |
| 7. <input type="checkbox"/> UNDERBUILT, | 14. <input type="checkbox"/> OTHER. |

COMMENTS: _____

Repair recommended: Yes No Enhancement to improve cover or effectiveness recommended: Yes No

HABITAT TYPE (associated with structure) _____ BANKFULL STREAM WIDTH _____ FT.

MAXIMUM POOL DEPTH _____ FT. DEPTH OF POOL TAIL CREST _____ FT.

SHELTER COMPLEXITY: 0 1 2 3 × SHELTER % COVER: _____ = SHELTER RATING: _____

OBSERVED SALMONIDS NO.: 0+ _____, 1+ _____, 2+ _____, ADULTS _____, REDDS _____

COMMENTS: _____

REVEGETATION: RIPARIAN ___ UPSLOPE ___ BOTH _____ (Photo required for reveg.) DESCRIBE DENSITY: _____

PHOTO NO. PRINT: ROLL _____ FRAME _____ SLIDE: ROLL _____ FRAME _____

COMMENTS: _____

CALIFORNIA SALMONID STREAM HABITAT RESTORATION MANUAL

APPENDIX S.

FISH SCREEN CRITERIA¹

DEPARTMENT OF FISH AND GAME

1. STRUCTURE PLACEMENT

A. Streams And Rivers (flowing water): The screen face shall be parallel to the flow and adjacent bankline (water's edge), with the screen face at or streamward of a line defined by the annual low-flow water's edge.

The upstream and downstream transitions to the screen structure shall be designed and constructed to match the back-line, minimizing eddies upstream of, in front of and downstream of, the screen.

Where feasible, this "on-stream" fish screen structure placement is preferred by the California Department of Fish and Game.

B. In Canals (flowing water): The screen structure shall be located as close to the river source as practical, in an effort to minimize the approach channel length and the fish return bypass length. This "in canal" fish screen location shall only be used where an "on-stream" screen design is not feasible. This situation is most common at existing diversion dams with headgate structures.

The current National Oceanic and Atmospheric Administration Fisheries - Southwest Region criteria for these types of installations shall be used.

C. Small Pumped Diversions: Small pumped diversions (less than 40 cubic-feet per second) which are screened using "manufactured, self-contained" screens shall conform to the National Oceanic and Atmospheric Administration Fisheries - Southwest Region criteria.

D. Non-Flowing Waters (tidal areas, lakes and reservoirs): The preferred location for the diversion intake structure shall be offshore, in deep water, to minimize fish contact with the diversion. Other configurations will be considered as exceptions to the screening criteria as described in Section 5.F. below.

2. APPROACH VELOCITY (Local velocity component perpendicular to the screen face)

A. Flow Uniformity: The design of the screen shall distribute the approach velocity uniformly across the face of the screen. Provisions shall be made in the design of the

¹ June 19, 2000 Version

CALIFORNIA SALMONID STREAM HABITAT RESTORATION MANUAL

screen to allow for adjustment of flow patterns. The intent is to ensure uniform flow distribution through the entire face of the screen as it is constructed and operated.

B. Self-Cleaning Screens: The design approach velocity shall not exceed:

1. Streams And Rivers (flowing waters) - Either:

a. 0.33 feet per second, where exposure to the fish screen shall not exceed fifteen minutes, or

b. 0.40 feet per second, for small (less than 40 cubic-feet per second) pumped diversions using Amanufactured, self-contained@ screens.

2. In Canals (flowing waters) - 0.40 feet per second, with a bypass entrance located every one-minute of travel time along the screen face.

3. Non-Flowing Waters (tidal areas, lakes and reservoirs) - The specific screen approach velocity shall be determined for each installation, based on the species and life stage of fish being protected. Velocities which exceed those described above will require a variance to these criteria (see Section 5.F. below).

(Note: At this time, the U.S. Fish and Wildlife Service has selected a 0.2 feet per second approach velocity for use in waters where the Delta smelt is found. Thus, fish screens in the Sacramento-San Joaquin Estuary should use this criterion for design purposes.)

C. Screens Which Are Not Self-Cleaning: The screens shall be designed with an approach velocity one-fourth that outlined in Section B. above. The screen shall be cleaned before the approach velocity exceeds the criteria described in Section B.

D. Frequency Of Cleaning: Fish screens shall be cleaned as frequently as necessary to prevent flow impedance and violation of the approach velocity criteria. A cleaning cycle once every 5 minutes is deemed to meet this standard.

E. Screen Area Calculation: The required wetted screen area (square feet), excluding the area affected by structural components, is calculated by dividing the maximum diverted flow (cubic-feet per second) by the allowable approach velocity (feet per second).

Example:

$$1.0 \text{ cubic-feet per second} / 0.33 \text{ feet per second} = 3.0 \text{ square feet}$$

Unless otherwise specifically agreed to, this calculation shall be done at the minimum stream stage.

3. SWEEPING VELOCITY (Velocity component parallel to screen face)

A. In Streams And Rivers: The sweeping velocity should be at least two times the allowable approach velocity.

CALIFORNIA SALMONID STREAM HABITAT RESTORATION MANUAL

B. In Canals: The sweeping velocity shall exceed the allowable approach velocity. Experience has shown that sweeping velocities of 2.0 feet per second (or greater) are preferable.

C. Design Considerations: Screen faces shall be designed flush with any adjacent screen bay piers or walls, to allow an unimpeded flow of water parallel to the screen face.

4. SCREEN OPENINGS

A. Porosity: The screen surface shall have a minimum open area of 27 percent. We recommend the maximum possible open area consistent with the availability of appropriate material, and structural design considerations.

The use of open areas less than 40 percent shall include consideration of increasing the screen surface area, to reduce slot velocities, assisting in both fish protection and screen cleaning.

B. Round Openings: Round openings in the screening shall not exceed 3.96mm (5/32in). In waters where steelhead rainbow trout fry are present, this dimension shall not exceed 2.38mm (3/32in).

C. Square Openings: Square openings in screening shall not exceed 3.96mm (5/32in) measured diagonally. In waters where steelhead rainbow trout fry are present, this dimension shall not exceed 2.38mm (3/32in) measured diagonally.

D. Slotted Openings: Slotted openings shall not exceed 2.38mm (3/32in) in width. In waters where steelhead rainbow trout fry are present, this dimension shall not exceed 1.75mm (0.0689in).

5. SCREEN CONSTRUCTION

A. Material Selection: Screens may be constructed of any rigid material, perforated, woven, or slotted that provides water passage while physically excluding fish. The largest possible screen open area which is consistent with other project requirements should be used. Reducing the screen slot velocity is desirable both to protect fish and to ease cleaning requirements. Care should be taken to avoid the use of materials with sharp edges or projections which could harm fish.

B. Corrosion And Fouling Protection: Stainless steel or other corrosion-resistant material is the screen material recommended to reduce clogging due to corrosion. The use of both active and passive corrosion protection systems should be considered.

Consideration should be given to anti-fouling material choices, to reduce biological fouling problems. Care should be taken not to use materials deemed deleterious to fish and other wildlife.

CALIFORNIA SALMONID STREAM HABITAT RESTORATION MANUAL

C. Project Review And Approval: Plans and design calculations, which show that all the applicable screening criteria have been met, shall be provided to the Department before written approval can be granted by the appropriate Regional Manager.

The approval shall be documented in writing to the project sponsor, with copies to both the Deputy Director, Habitat Conservation Division and the Deputy Director, Wildlife and Inland Fisheries Division. Such approval may include a requirement for post-construction evaluation, monitoring and reporting.

D. Assurances: All fish screens constructed after the effective date of these criteria shall be designed and constructed to satisfy the current criteria. Owners of existing screens, approved by the Department prior to the effective date of these criteria, shall not be required to upgrade their facilities to satisfy the current criteria unless:

1. The controlling screen components deteriorate and require replacement (i.e., change the opening size or opening orientation when the screen panels or rotary drum screen coverings need replacing),
2. Relocation, modification or reconstruction (i.e., a change of screen alignment or an increase in the intake size to satisfy diversion requirements) of the intake facilities, or
3. The owner proposes to increase the rate of diversion which would result in violation of the criteria without additional modifications.

E. Supplemental Criteria: Supplemental criteria may be issued by the Department for a project, to accommodate new fish screening technology or to address species-specific or site-specific circumstances.

F. Variances: Written variances to these criteria may be granted with the approval of the appropriate Regional Manager and concurrence from both the Deputy Director, Habitat Conservation Division and the Deputy Director, Wildlife and Inland Fisheries Division. At a minimum, the rationale for the variance must be described and justified in the request.

Evaluation and monitoring may be required as a condition of any variance, to ensure that the requested variance does not result in a reduced level of protection for the aquatic resources.

It is the responsibility of the project sponsor to obtain the most current version of the appropriate fish screen criteria. Project sponsors should contact the Department of Fish and Game, the National Oceanic and Atmospheric Administration Fisheries (for projects in marine and anadromous waters) and the U.S. Fish and Wildlife Service (for projects in anadromous and fresh waters) for guidance.

Copies of the current criteria are available from the Department of Fish and Game through the appropriate Regional office, which should be the first point of contact for any fish screening project.

CALIFORNIA SALMONID STREAM HABITAT RESTORATION MANUAL

Northern California and North Coast Region; 601 Locust Street, Redding, CA 96001 - (530) 225-2300.

Sacramento Valley and Central Sierra Region; 1701 Nimbus Drive, Rancho Cordova, CA 95670 - (916) 358-2900.

Central Coast Region; 7329 Silverado Trail/P.O. Box 46, Yountville, CA 94599 - (707) 944-5500.

San Joaquin Valley-Southern Sierra Region; 1234 E. Shaw Avenue, Fresno, CA 93710 - (209) 243-4005.

South Coast Region; 4649 View Crest Avenue, San Diego, CA 92123 - (619) 467-4201.

Eastern Sierra and Inland Deserts Region; 4775 Bird Farms Road, Chino Hills, CA 91709 - (909) 597-9823.

Marine Region; 20 Lower Ragsdale Drive, #100, Monterey, CA 93940 - (831) 649-2870.

Technical assistance can be obtained directly from the Habitat Conservation Division; 1416 Ninth Street, Sacramento, CA 95814 - (916) 653-1070.

The current National Oceanic and Atmospheric Administration Fisheries criteria are available from their Southwest Region; 777 Sonoma Avenue, Room 325, Santa Rosa, CA 95402 - (707) 575-6050.

CALIFORNIA SALMONID STREAM HABITAT RESTORATION MANUAL

Fish Screening Criteria for Anadromous Salmonids ¹ National Oceanic and Atmospheric Administration Fisheries Southwest Region

January 1997

I. General Considerations

This document provides guidelines and criteria for functional designs of downstream migrant fish passage facilities at hydroelectric, irrigation, and other water withdrawal projects. It is promulgated by the National Oceanic and Atmospheric Administration Fisheries (NOAA), Southwest Region as a result of its authority and responsibility for prescribing fishways under the Endangered Species Act (ESA), the Federal Power Act, administered by the Federal Energy Regulatory Commission (FERC), and the Fish and Wildlife Coordination Act (FWCA), administered by the U.S. Fish and Wildlife Service.

The guidelines and criteria are general in nature. There may be cases where site constraints or extenuating circumstances dictate a waiver or modification of one or more of these criteria. Conversely, where there is an opportunity to protect fish, site-specific criteria may be added. Variances from established criteria will be considered on a project-by-project basis.

The swimming ability of fish is a primary consideration in designing a fish screen facility. Research shows that swimming ability varies depending on multiple factors relating to fish physiology, biology, and the aquatic environment. These factors include: species, physiological development, duration of swimming time required, behavioral aspects, physical condition, water quality, temperature, lighting conditions, and many others. Since conditions affecting swimming ability are variable and complex, screen criteria must be expressed in general terms and the specifics of any screen design must address on-site conditions.

NOAA may require project sponsors to investigate site-specific variables critical to the fish screen system design. This investigation may include fish behavioral response to hydraulic conditions, weather conditions (ice, wind, flooding, etc.), river stage-discharge relationships, seasonal operations, sediment and debris problems, resident fish populations, potential for creating predation opportunity, and other pertinent information. The size of salmonids present at a potential screen site usually is not known, and can change from year-to-year based on flow and temperature conditions. Thus, adequate data to describe the size-time relationship requires substantial sampling over a number of years. NOAA will normally assume that fry-sized salmonids are present at all sites unless adequate biological investigation proves otherwise. The burden of proof is the responsibility of the owner of the screen facility.²

New facilities which propose to utilize unproven fish protection technology frequently require: 1) development of a biological basis for the concept; 2) demonstration of favorable behavioral responses in a laboratory setting; 3) an acceptable plan for evaluating the prototype installation;

² Adapted from NOAA, Southwest Region

CALIFORNIA SALMONID STREAM HABITAT RESTORATION MANUAL

and 4) an acceptable alternate plan should the prototype not adequately protect fish. Additional information can be found in *Experimental Fish Guidance Devices*, position statement of the National Oceanic and Atmospheric Administration Fisheries, Southwest Region, January 1994.

Striped Bass, Herring, Shad, Cyprinids, and other anadromous fish species may have eggs and/or very small fry which are moved with any water current (tides, streamflows, etc.). Installations where these species are present may require individual evaluation of the proposed project using more conservative screening requirements. In instances where state or local regulatory agencies require more stringent screen criteria to protect species other than salmonids, NOAA will generally defer to the more conservative criteria.

General screen criteria and procedural guidelines are provided below. Specific exceptions to these criteria occur in the design of small screen systems (less than 40 cubic feet per second) and certain small pump intakes. These exceptions are listed in Section K. Modified Criteria for Small Screens, and in the separate addendum entitled: Juvenile Fish Screen Criteria For Pump Intakes, National Oceanic and Atmospheric Administration Fisheries, Portland, Oregon, May 9, 1996.

II. General Procedural Guidelines

For projects where NOAA had jurisdiction, such as FERC license applications and ESA consultations, a functional design must be developed as part of the application or consultation. These designs must reflect NOAA design criteria and be acceptable to NOAA. Acceptable designs typically define type, location, method of operation, and other important characteristics of the fish screen facility. Design drawings should show structural dimensions in plan, elevation, and cross-sectional views, along with important component details. Hydraulic information should include: hydraulic capacity, expected water surface elevations, and flows through various areas of the structures. Documentation of relevant hydrologic information is required. Types of materials must be identified where they will directly affect fish. A plan for operations and maintenance procedures should be included-i.e., preventive and corrective maintenance procedures, inspections and reporting requirements, maintenance logs, etc. - particularly with respect to debris, screen cleaning, and sedimentation issues. The final detailed design shall be based on the functional design, unless changes are agreed to by NOAA.

All juvenile passage facilities shall be designed to function properly through the full range of hydraulic conditions expected at a particular site during fish migration periods, and shall account for debris and sedimentation conditions which may occur.

III. Screen Criteria for Juvenile Salmonids

A. Structure Placement

1. General:

The screened intake shall be designed to withdraw water from the most appropriate elevation, considering juvenile fish attraction, appropriate water temperature control downstream or a combination thereof. The design must accommodate the expected range of water surface elevations.

CALIFORNIA SALMONID STREAM HABITAT RESTORATION MANUAL

For on-river screens, it is preferable to keep the fish in the main channel rather than put them through intermediate screen bypasses. NOAA decides whether to require intermediate bypasses for on-river, straight profile screens by considering the biological and hydraulic conditions existing at each individual project site.

2. Streams and Rivers:

Where physically practical, the screen shall be constructed at the diversion entrance. The screen face should be generally parallel to river flow and aligned with the adjacent bankline. A smooth transition between the bankline and the screen structure is important to minimize eddies and undesirable flow patterns in the vicinity of the screen. If trash racks are used, sufficient hydraulic gradient is required to route juvenile fish from between the trash rack and screens to safety. Physical factors that may preclude screen construction at the diversion entrance include excess river gradient, potential for damage by large debris, and potential for heavy sedimentation. Large stream-side installations may require intermediate bypasses along the screen face to prevent excessive exposure time. The need for intermediate bypasses shall be decided on a case-by-case basis.

3. Canals:

Where installation of fish screens at the diversion entrance is undesirable or impractical, the screens may be installed at a suitable location downstream of the canal entrance. All screens downstream of the diversion entrance shall provide an effective juvenile bypass system - designed to collect juvenile fish and safely transport them back to the river with minimum delay. The angle of the screen to flow should be adequate to effectively guide fish to the bypass. Juvenile bypass systems are part of the overall screen system and must be accepted by NOAA.

4. Lakes, Reservoirs, and Tidal Areas

a. Where possible, intakes should be located off shore to minimize fish contact with the facility. Water velocity from any direction toward the screen shall not exceed the allowable approach velocity. Where possible, locate intakes where sufficient sweeping velocity exists. This minimizes sediment accumulation in and around the screen, facilitates debris removal, and encourages fish movement away from the screen face.

b. If a screen intake is used to route fish past a dam, the intake shall be designed to withdraw water from the most appropriate elevation in order to provide the best juvenile fish attraction to the bypass channel as well as to achieve appropriate water temperature control downstream. The entire range of forebay fluctuations shall be accommodated by the design, unless otherwise approved by NOAA.

B. Approach Velocity

Definition: *Approach Velocity* is the water velocity vector component perpendicular to the screen face. Approach velocity shall be measured approximately three inches in front of the screen surface.

CALIFORNIA SALMONID STREAM HABITAT RESTORATION MANUAL

1. Fry Criteria - less than 2.36 inches {60 millimeters (mm)} in length.

If a biological justification cannot demonstrate the absence of fry-sized salmonids in the vicinity of the screen, fry will be assumed present and the following criteria apply:

Design approach velocity shall not exceed:
Streams and Rivers: 0.33 feet per second
Canals: 0.40 feet per second
Lakes, Reservoirs, Tidal: 0.33 feet per second (salmonids)³

2. Fingerling Criteria - 2.36 inches {60 mm} and longer

If biological justification can demonstrate the absence of fry-sized salmonids in the vicinity of the screen, the following criteria apply:

Design approach velocity shall not exceed:
All locations: 0.8 feet per second

3. The *total submerged screen area required* (excluding area of structural components) is calculated by dividing the maximum diverted flow by the allowable approach velocity. (Also see Section K, Modified Criteria for Small Screens, part 1).
4. The screen design must provide for uniform flow distribution over the surface of the screen, thereby minimizing approach velocity. This may be accomplished by providing adjustable porosity control on the downstream side of the screens, unless it can be shown unequivocally (such as with a physical hydraulic model study) that localized areas of high velocity can be avoided at all flows.

C. Sweeping Velocity

Definition: *Sweeping Velocity* is the water velocity vector component parallel and adjacent to the screen face.

1. Sweeping Velocity shall be greater than approach velocity. For canal installations, this is accomplished by angling screen face less than 45° relative to flow (see Section K. Modified Criteria for Small Screens). This angle may be dictated by specific canal geometry, or hydraulic and sediment conditions.

D. Screen Face Material

³ Other species may require different approach velocity standards. e.g. in California the U.S. Fish & Wildlife Service requires 0.2 fps approach velocity where delta smelt are present in the tidal areas of the San Francisco Bay estuary.

CALIFORNIA SALMONID STREAM HABITAT RESTORATION MANUAL

1. Fry criteria. If a biological justification cannot demonstrate the absence of fry-sized salmonids in the vicinity of the screen, fry will be assumed present and the following criteria apply for screen material:

- a. Perforated plate: screen openings shall not exceed 3/32 inches (2.38 mm), measured in diameter.
- b. Profile bar: screen openings shall not exceed 0.0689 inches (1.75 mm) in width.
- c. Woven wire: Screen openings shall not exceed 3/32 inches (2.38 mm), measured diagonally (e.g.: 6-14 mesh).
- d. Screen material shall provide a minimum of 27% open area.

2. Fingerling criteria

If biological justification can demonstrate the absence of fry-sized salmonids in the vicinity of the screen, the following criteria apply for screen material:

- a. Perforated plate: Screen openings shall not exceed 1/4 inch (6.35 mm) in diameter.
 - b. Profile bar: screen openings shall not exceed 1/4 inch (6.35 mm) in width.
 - c. Woven wire: Screen openings shall not exceed 1/4 inch (6.35 mm) in the narrow direction.
 - d. Screen material shall provide a minimum of 40% open area.
3. The screen material shall be corrosion resistant and sufficiently durable to maintain a smooth and uniform surface with long term use.

E. Civil Works and Structural Features

1. The face of all screen surfaces shall be placed flush with any adjacent screen bay, pier noses, and walls, allowing fish unimpeded movement parallel to the screen face and ready access to bypass routes.
2. Structural features shall be provided to protect the integrity of the fish screens from large debris. Trash racks, log booms, sediment sluices, or other measures may be needed. A reliable on-going preventive maintenance and repair program is necessary to ensure facilities are kept free of debris and the screen mesh, seals, drive units, and other components are functioning correctly.
3. Screens located in canals - surfaces shall be constructed at an angle to the approaching flow, with the downstream end terminating at the bypass system entrance.
4. The civil works design shall attempt to eliminate undesirable hydraulic effects (e.g. - eddies, stagnant flow zones) that may delay or injure fish, or provide predator opportunities. Upstream training wall(s), or some acceptable variation thereof, shall be utilized to control hydraulic

CALIFORNIA SALMONID STREAM HABITAT RESTORATION MANUAL

conditions and define the angle of flow to the screen face. Large facilities may require hydraulic monitoring to identify and correct areas of concern.

F. Juvenile Bypass System Layout

Juvenile bypass systems are water channels which transport juvenile fish from the face of a screen to a relatively safe location in the main migratory route of the river or stream. Juvenile bypass systems are necessary for screens located in canals because anadromous fish must be routed back to their main migratory route. For other screen locations and configurations, NOAA accepts the option which, in its judgement, provides the highest degree of fish protection given existing site and project constraints.

1. The screen and bypass shall work in tandem to move out-migrating salmonids (including adults) to the bypass outfall with minimum injury or delay. Bypass entrance(s) shall be designed such that out-migrants can easily locate and enter them. Screens installed in canal diversions shall be constructed with the downstream end of the screen terminating at a bypass entrance. Multiple bypass entrances (intermediate bypasses) shall be employed if the sweeping velocity will not move fish to the bypass within 60 seconds⁴ assuming the fish are transported at this velocity. Exceptions will be made for sites without sufficient hydraulic conditions, or for screens built on river banks with satisfactory river conditions.
2. All components of the bypass system, from entrance to outfall, shall be of sufficient hydraulic capacity to minimize the potential for debris blockage.
3. To improve bypass collection efficiency for a single bank of vertically oriented screens, a bypass training wall may be located at an angle to the screens.
4. In cases where insufficient flow is available to satisfy hydraulic requirements at the main bypass entrance(s), a *secondary screen* may be required. Located in the main screen=s bypass channel, a secondary screen allows the prescribed bypass flow to be used to effectively attract fish into the bypass entrance(s) while allowing all but a reduced residual bypass flow to be routed back (by pump or gravity) for the primary diversion use. The residual bypass flow (not passing through the secondary screen) then conveys fish to the bypass outfall location or other destination.
5. Access is required at locations in the bypass system where debris accumulation may occur.
6. The screen civil works floor shall allow fish to be routed to the river safely in the event the canal is dewatered. This may entail a sumped drain with a small gate and drain pipe, or similar provisions.

⁴ In California, 60 second exposure time applies to screens in canals, using a 0.4 fps approach velocity. Where more conservative approach velocities are used, longer exposure times may be approved on a case-by-case basis, and exceptions to established criteria shall be treated as variances.

CALIFORNIA SALMONID STREAM HABITAT RESTORATION MANUAL

G. Bypass Entrance

1. Each bypass entrance shall be provided with independent flow control, acceptable to NOAA.
2. Bypass entrance velocity must equal or exceed the maximum velocity vector resultant along the screen, upstream of the entrance. A gradual and efficient acceleration into the bypass is required to minimize delay of out-migrants.
3. Ambient lighting conditions are required from the bypass entrance to the bypass flow control.
4. The bypass entrance must extend from floor to water surface.

H. Bypass Conduit Design

1. Smooth interior pipe surfaces and conduit joints shall be required to minimize turbulence, debris accumulation, and the risk of injury to juvenile fish. Surface smoothness must be acceptable to the NOAA.
2. Fish shall not free-fall within a confined shaft in a bypass system.
3. Fish shall not be pumped within the bypass system.
4. Pressure in the bypass pipe shall be equal to or above atmospheric pressure.
5. Extreme bends shall be avoided in the pipe layout to avoid excessive physical contact between small fish and hard surfaces and to minimize debris clogging. Bypass pipe centerline radius of curvature (R/D) shall be 5 or greater. Greater R/D may be required for supercritical velocities.
6. Bypass pipes or open channels shall be designed to minimize debris clogging and sediment deposition and to facilitate cleaning. Pipe diameter shall be 24 inches (0.610 m) or greater and pipe velocity shall be 2.0 fps (0.610 mps) or greater, unless otherwise approved by NOAA. (See *Modified Criteria for Small Screens* for the entire operational range).
7. No closure valves are allowed within bypass pipes.
8. Depth of flow in a bypass conduit shall be 0.75 ft. (0.23 m) or greater, unless otherwise authorized by NOAA. (See *Modified Criteria for Small Screens*).
9. Bypass system sampling stations shall not impair normal operation of the screen facility.
10. No hydraulic jumps should exist within the bypass system.

I. Bypass Outfall

1. Ambient river velocities at bypass outfalls should be greater than 4.0 fps (1.2 mps), or as close as obtainable.

CALIFORNIA SALMONID STREAM HABITAT RESTORATION MANUAL

2. Bypass outfalls shall be located and designed to minimize avian and aquatic predation in areas free of eddies, reverse flow, or known predator habitat.
3. Bypass outfalls shall be located where there is sufficient depth (depending on the impact velocity and quantity of bypass flow) to avoid fish injuries at all river and bypass flows.
4. Impact velocity, including vertical and horizontal components, shall not exceed 25.0 fps (7.6 mps).
5. Bypass outfall discharges shall be designed to avoid adult attraction or jumping injuries.

J. Operations and Maintenance

1. Fish screens shall be automatically cleaned as frequently as necessary to prevent accumulation of debris. The cleaning system and protocol must be effective, reliable, and satisfactory to NOAA. Proven cleaning technologies are preferred.
2. Open channel intakes shall include a trash rack in the screen facility design which shall be kept free of debris. In certain cases, a satisfactory profile bar screen design can substitute for a trash rack.
3. The head differential to trigger screen cleaning for intermittent type systems shall be a maximum of 0.1 feet (.03 m), unless otherwise agreed to by NOAA.
4. The completed screen and bypass facility shall be made available for inspection by NOAA to verify compliance with design and operational criteria.
5. Screen and bypass facilities shall be evaluated for biological effectiveness and to verify that hydraulic design objectives are achieved.

K. Modified Criteria for Small Screens (Diversion Flow less than 40 cfs)

The following criteria vary from the standard screen criteria listed above. These criteria specifically apply to small screens. Forty cfs is the approximate cut off: however, some smaller diversions may be required to apply the general criteria listed above, while some larger diversions may be allowed to use the small screen criteria below. NOAA will decide on a case-by-case basis depending on site constraints.

1. The required screen area is a function of the approach velocity listed in Section B, Approach Velocity, Parts 1, 2, and 3 above. Note that A_{maximum} refers to the greatest flow diverted, not necessarily the water right.
2. Screen Orientation:
 - a. For screen lengths six feet or less, screen orientation may be angles perpendicular to the flow.

CALIFORNIA SALMONID STREAM HABITAT RESTORATION MANUAL

- b. For screen lengths greater than six feet, screen-to-flow angle must be less than 45 degrees. (See Section C Sweeping Velocity, part 1).
- c. For drum screens, design submergence shall be 75% of drum diameter. Submergence shall not exceed 85%, nor be less than 65% of drum diameter.
- d. Minimum bypass pipe diameter shall be 10 inches (25.4 cm), unless otherwise approved by NOAA.
- e. Minimum pipe depth is 1.8 inches (4.6 cm) and is controlled by designing the pipe gradient for minimum bypass flow.

Questions concerning this document can be directed to NOAA Hydraulic Engineering Staff at:

National Oceanic and Atmospheric Administration Fisheries
Southwest Region
777 Sonoma Ave., Room 325
Santa Rosa, CA 95402
Phone: (707) 575-6050

CALIFORNIA SALMONID STREAM HABITAT RESTORATION MANUAL

Fish Screen Operation and Maintenance Best Management Practices

- Fish screens shall be operated and maintained in compliance with current law, including Fish and Game Code, and Department of Fish and Game (DFG) fish screening criteria. DFG screening criteria may be referenced on the internet at:
http://www.dfg.ca.gov/fish/Resources/Projects/Engin/Engin_ScreenCriteria.asp
- Notwithstanding Fish and Game Code section 6027, fish screens and bypass pipes or channels shall be in-place and maintained in working order at all times water is being diverted.
- If a screen site is dewatered for repairs or maintenance when targeted fish species are likely to be present, measures will be taken to minimize harm and mortality to targeted species resulting from fish relocation and dewatering activities. The responsible party shall notify DFG before the project site is de-watered and the stream flow diverted. The notification will provide a reasonable time for DFG personnel to supervise the implementation of a water diversion plan and oversee the safe removal and relocation of salmonids and other fish life from the project area. If the project requires dewatering of the site, and the relocation of salmonids, the responsible party will implement the following measures to minimize harm and mortality to listed salmonids:
- All electrofishing shall be performed by a qualified fisheries biologist and conducted according to the National Marine Fisheries Service (NMFS), Guidelines for Electrofishing Waters Containing Salmonids Listed under the Endangered Species Act, June 2000.
- The responsible party will provide fish relocation data to DFG on a form provided by the DFG, unless the relocation work is performed by DFG personnel.
- Additional measures to minimize injury and mortality of salmonids during fish relocation and dewatering activities shall be implemented as described in Part IX, pages 52 and 53 of the *California Salmonid Stream Habitat Restoration Manual*.
- If a fish screen is removed for cleaning or repair, a replacement screen shall be installed immediately or the diversion shut down until a screen is in place.
- Fish screens shall be inspected and maintained regularly (not less than two times per week) to ensure that they are functioning as designed and meeting DFG fish screening criteria.
- Existing roads shall be used to access screen sites with vehicles and/or equipment whenever possible. If it is necessary to create access to a screen site for repairs or maintenance, access points should be identified at stable stream bank locations which minimize riparian disturbance.
- Sediment and debris removal at a screen site shall take place as often as needed to ensure that screening criteria are met. Sediment and debris will be removed and disposed of where they will not re-enter the water course.

CALIFORNIA SALMONID STREAM HABITAT RESTORATION MANUAL

- Stationary equipment used in performing screen maintenance and repairs, such as motors, pumps, generators, and welders, located within or adjacent to a stream shall be positioned over drip pans.
- Equipment which is used to maintain and/or repair fish screens shall be in good condition and checked and maintained on a daily basis to prevent leaks of materials that could be deleterious to aquatic life, wildlife, or riparian habitat.
- All activities performed in or near a stream will have absorbent materials designed for spill containment and cleanup at the activity site for use in case of an accidental spill. Clean-up of spills shall begin immediately after any spill occurs. The State Office of Emergency Services (1-800-852-7550) and DFG shall be notified immediately after any spill occurs.
- To the extent possible repairs to a fish screen or screen site shall be made during a period of time when the target species of fish are not likely to be present (for example, in a seasonal creek, repair work should be performed when the stream is dry).
- Equipment used to maintain and/or repair fish screens shall not operate in a live stream except as may be necessary to construct coffer dams to divert stream flow and isolate the work site.
- For minor actions, where the disturbance to construct coffer dams to isolate the work site would be greater than to complete the action, measures will be put in place immediately downstream of the work site to capture suspended sediment.
- Turbid water which is generated by screen maintenance or repair activities shall be discharged to an area where it will not re-enter the stream. If the DFG determines that turbidity/siltation levels resulting from screen maintenance or repair activities constitute a threat to aquatic life, all activities associated with the turbidity/siltation shall cease until effective DFG-approved sediment control devices are installed and/or abatement procedures are implemented.
- No debris, soil, silt, sand, bark, slash, spoils, sawdust, rubbish, cement, or concrete or washings thereof; asphalt, paint, or other coating material; oil or petroleum products; or other organic or earthen material from any fish screen operation/maintenance/repair or associated activity of whatever nature shall be allowed to enter into, or placed where it may be washed by rainfall or runoff into a stream channel. When operations are completed, any excess materials or debris shall be removed from the work area and disposed of in a lawful manner.