

# California 4-H Horse Classic

## English Showmanship (Novice Rider and Green Horse)

Show Date: 07-8-2024

w w w . H o r s e S h o w P a t t e r n s . c o m

w w w . H o r s e S h o w P a t t e r n s . c o m

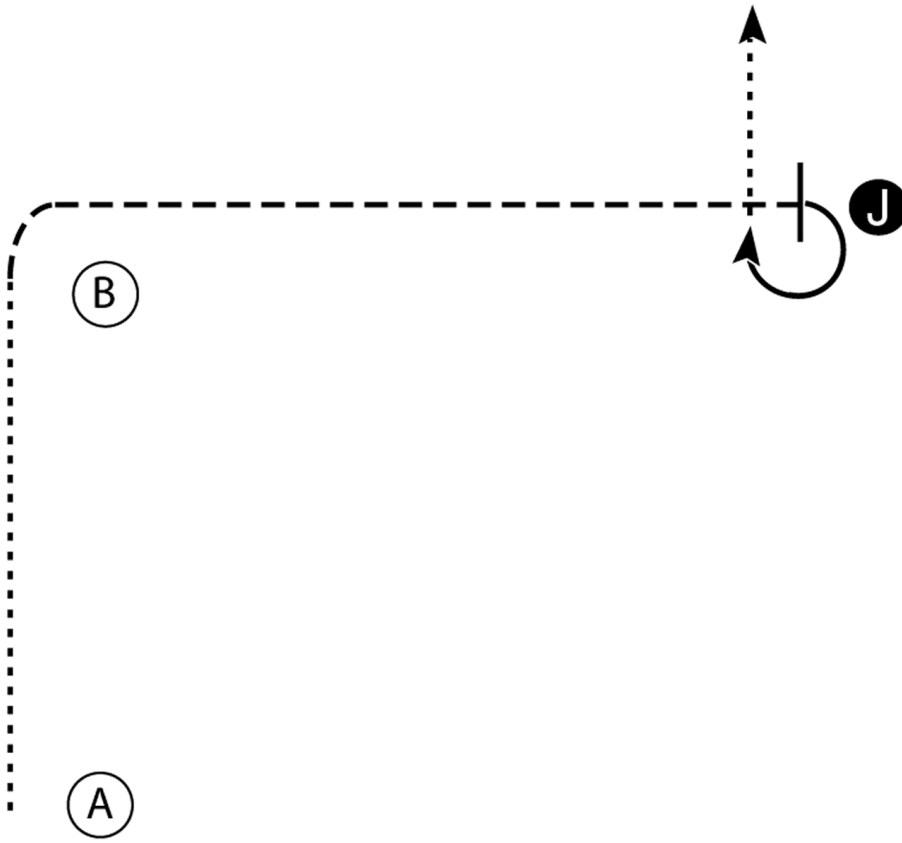



1. Walk from A to B.
2. Trot from B to the Judge.
3. Stop and set up for inspection.
4. When dismissed perform a 270 degree turn and walk straight away from the Judge.

Walk 

Trot 

Back 

Marker 

Judge 

[S/WT-2]

Pattern Provided by:

California 4-H Horse Classic

# California 4-H Horse Classic

## English Showmanship (Junior)

Show Date: 07-8-2024

w w w . H o r s e S h o w P a t t e r n s . c o m

w w w . H o r s e S h o w P a t t e r n s . c o m

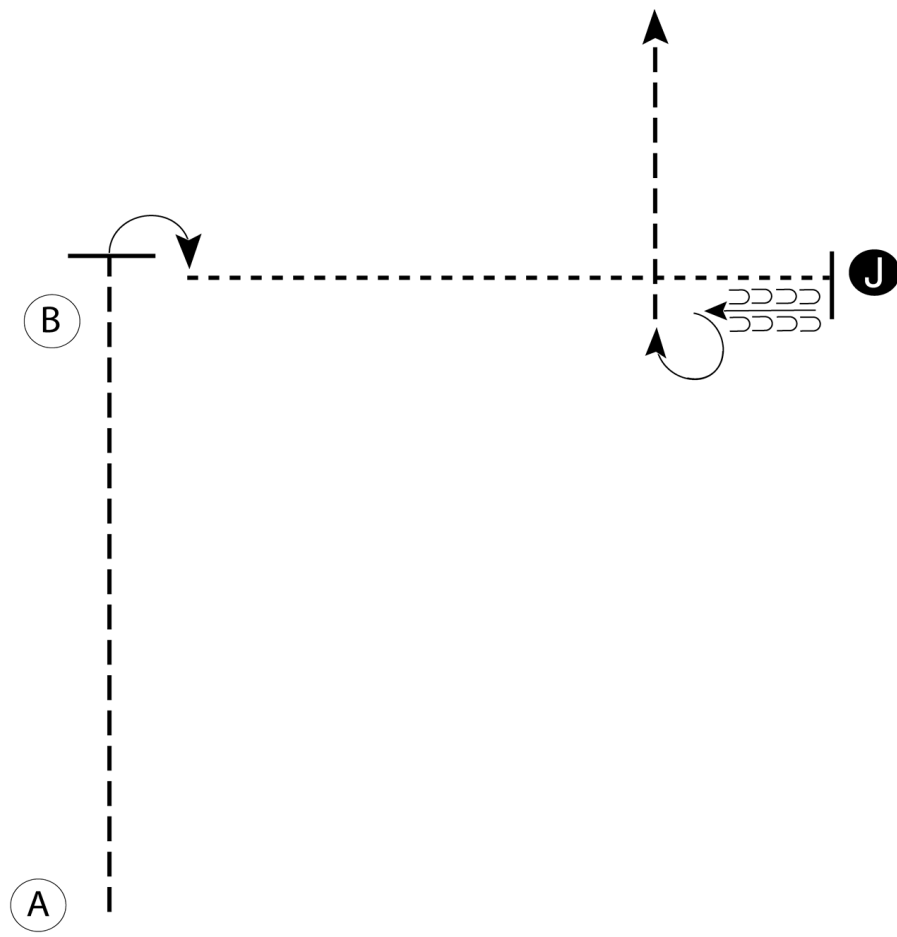

1. Begin at A. Trot from A past B
2. Stop and perform a 90 degree turn
3. Walk to the Judge, stop and set up for inspection
4. When dismissed back one horse length and perform a 270 degree turn
5. Trot to the line-up

- Walk - - - - -
- Trot - . - . - .
- Back ← — — — — —
- Marker (B)
- Judge (J)

[S/1-14]

Pattern Provided by:

California 4-H Horse Classic

# California 4-H Horse Classic

## English Showmanship (Senior)

Show Date: 07-8-2024

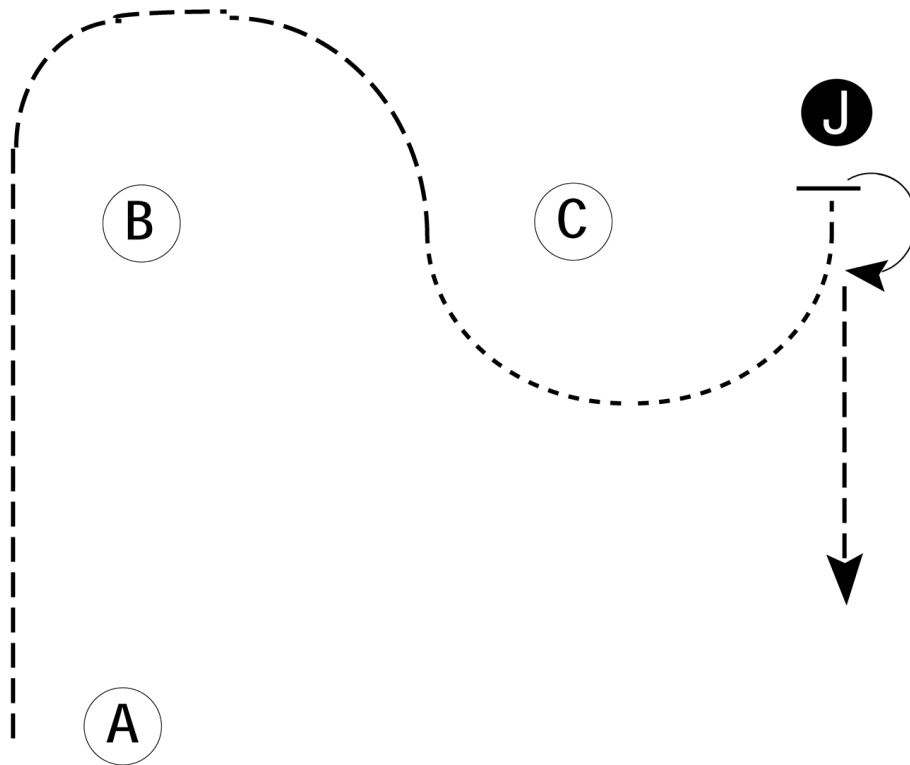

Be ready at A.

1. Trot from A around B and to C.
2. Walk from C to the Judge.
3. Stop and set up for inspection.
4. When dismissed, perform a 180 degree turn.
5. Trot straight away from the Judge.

Follow the instructions of your ring steward.

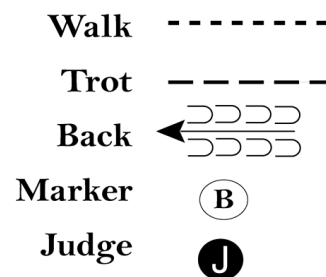

[S/1-35]

Pattern Provided by:

California 4-H Horse Classic

# California 4-H Horse Classic

## Hunt Seat Equitation (Novice Rider and Green Horse)

Show Date: 07-8-2024

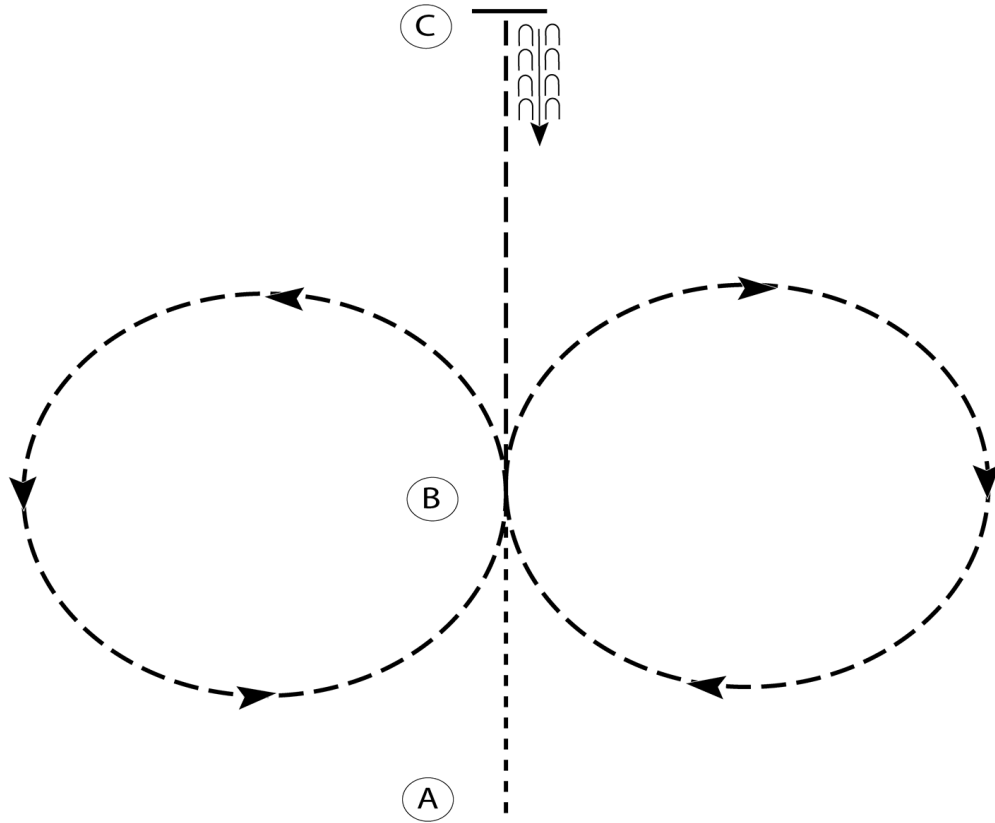

1. Walk A to B.
2. At B posting trot a circle to the right on the proper diagonal.
3. At B posting trot a circle to the left on the proper diagonal.
4. At B sitting trot to C.
5. At C stop and back approximately one horse length.

Walk	.....
Trot	- - - - -
Extended Trot	- - - - -
Canter	—————
Leg Yield	
Lead Change	— / —
Back	←←←←←
Marker	(B)
Sidepass	← — — — — →
Hand Gallop	— / — / — / —

[HSE/WT-5]

Pattern Provided by:

California 4-H Horse Classic

# California 4-H Horse Classic

## Hunt Seat Equitation (Junior)

Show Date: 07-8-2024

w w w . H o r s e S h o w P a t t e r n s . c o m

w w w . H o r s e S h o w P a t t e r n s . c o m

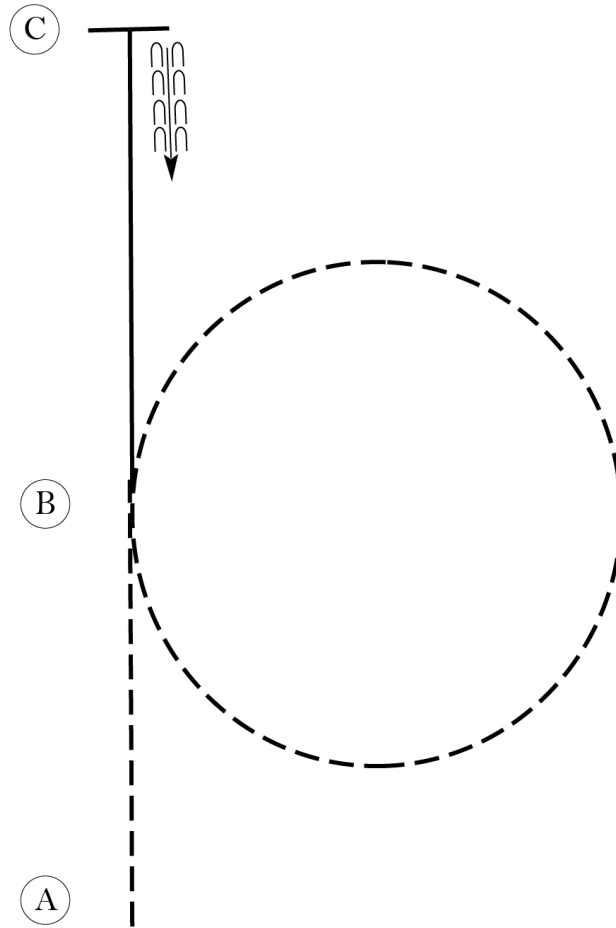

Be ready before A.

1. Sitting trot A to B.
2. At B, posting trot circle to the right on proper diagonal.
3. At B, canter on the left lead to C.
4. Stop at C and back approximately one horse length.

Walk	-----
Trot	- - - - -
Extended Trot	— — — — —
Canter	—————
Leg Yield	
Lead Change	↙ ↘
Back	← ← ← ← ←
Marker	(B)
Sidepass	← — — — — →
Hand Gallop	—————

[HSE/1-2]

Pattern Provided by:

California 4-H Horse Classic

# California 4-H Horse Classic

## Hunt Seat Equitation (Senior)

Show Date: 07-8-2024

w w w . H o r s e S h o w P a t t e r n s . c o m

w w w . H o r s e S h o w P a t t e r n s . c o m

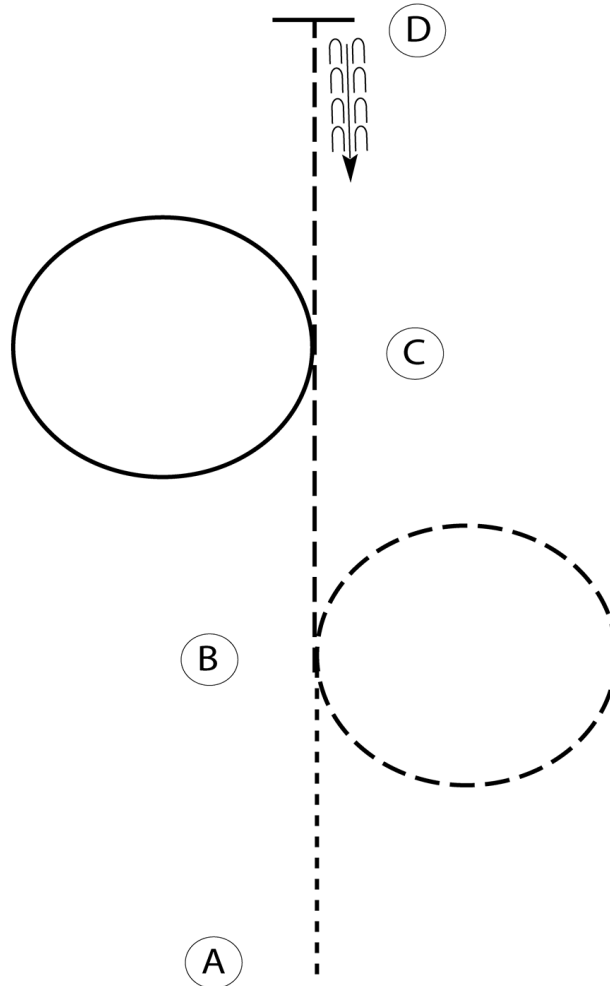

Be ready at A.

1. Walk from A to B.
2. At B, posting trot circle to the right on proper diagonal.
3. Continue posting trot to C.
4. At C, canter a circle to the left on the left lead.
5. After returning to C, break to a sitting trot from C to D.
6. At D, stop and back approximately one horse length.

Follow the instructions of your ring steward.

Walk	-----
Trot	- - - - -
Extended Trot	— — — — —
Canter	—————
Leg Yield	
Lead Change	— / —
Back	← ← ← ← ←
Marker	(B)
Sidepass	← — — — — →
Hand Gallop	— — — — —

[HSE/1-29]

Pattern Provided by:

California 4-H Horse Classic

# California 4-H Horse Classic

## Equitation Over Ground Poles W/T (Open)

Show Date: 07-8-2024

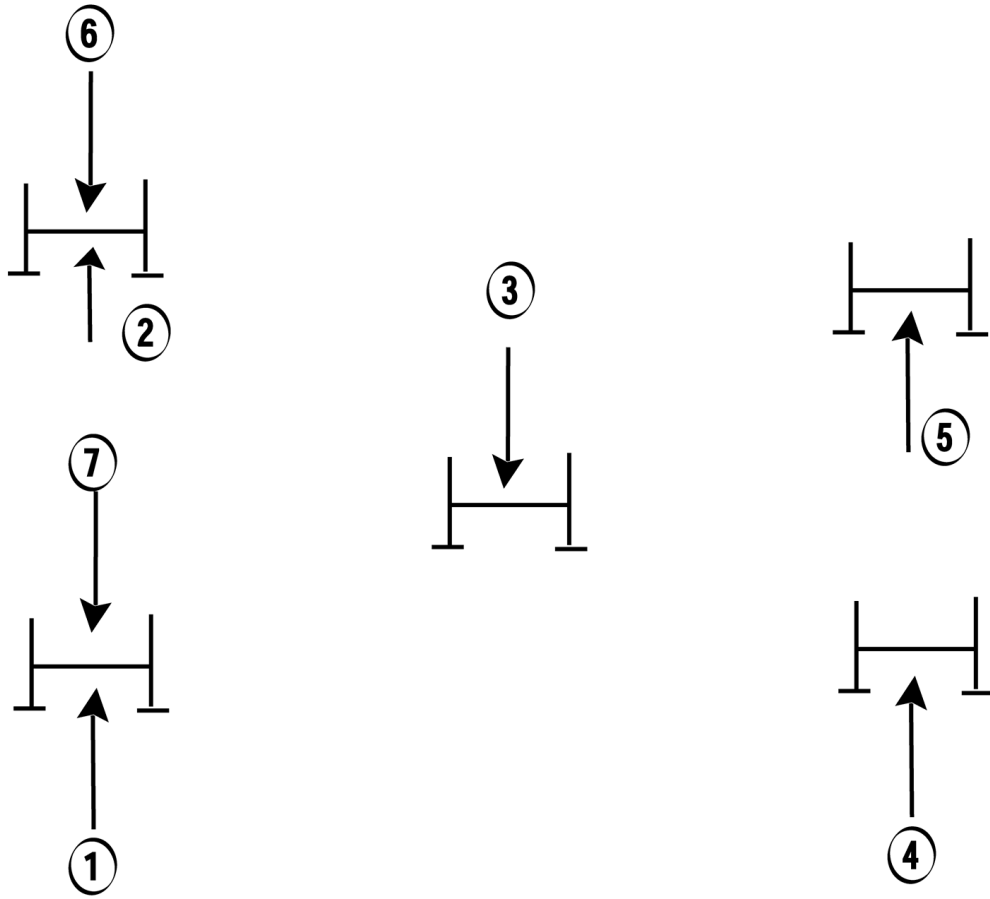

w w w . H o r s e S h o w P a t t e r n s . c o m

w w w . H o r s e S h o w P a t t e r n s . c o m

[MHP/H-7]

Pattern Provided by:

*California 4-H Horse Classic*

# California 4-H Horse Classic

## Equitation Over Ground Poles W/T/C (Open )

Show Date: 07-8-2024

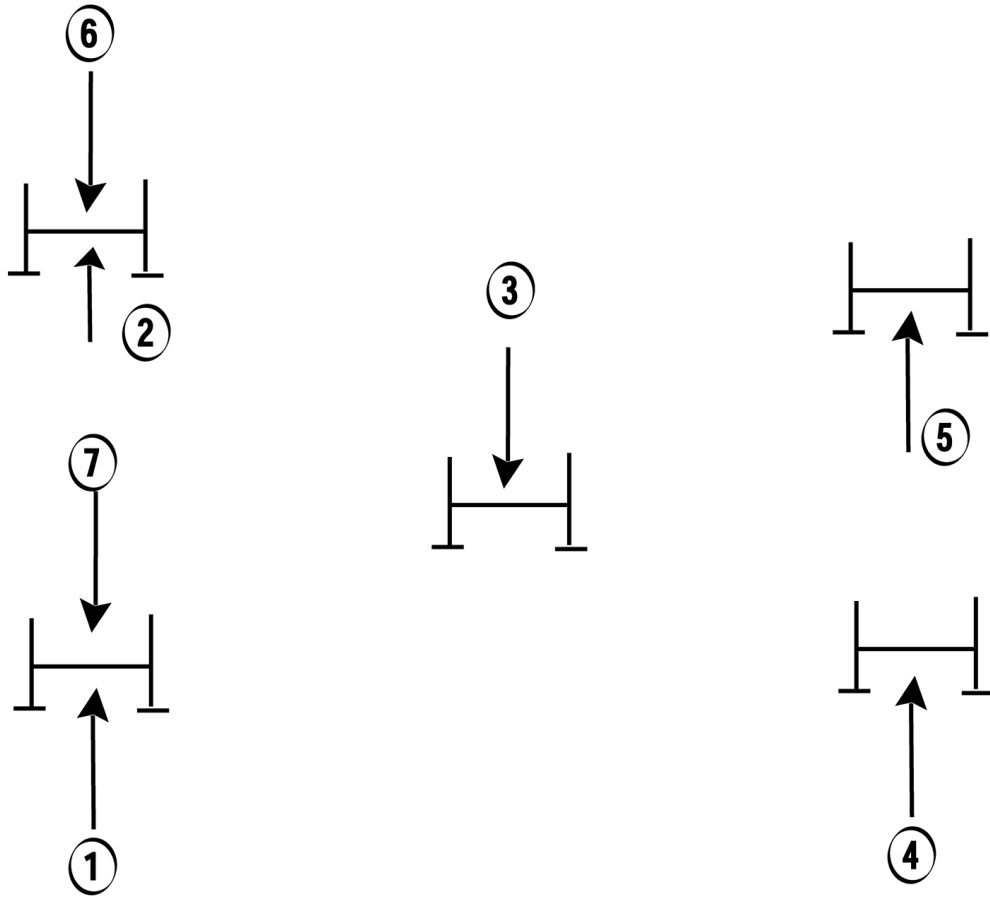

w w w . H o r s e S h o w P a t t e r n s . c o m

w w w . H o r s e S h o w P a t t e r n s . c o m

[MHP/H-7]

Pattern Provided by:

*California 4-H Horse Classic*



# California 4-H Horse Classic

## Hunter Hack X-Rails up to 18" (Open (except Novice))

Show Date: 07-8-2024

www.HorseShowPatterns.com

www.HorseShowPatterns.com

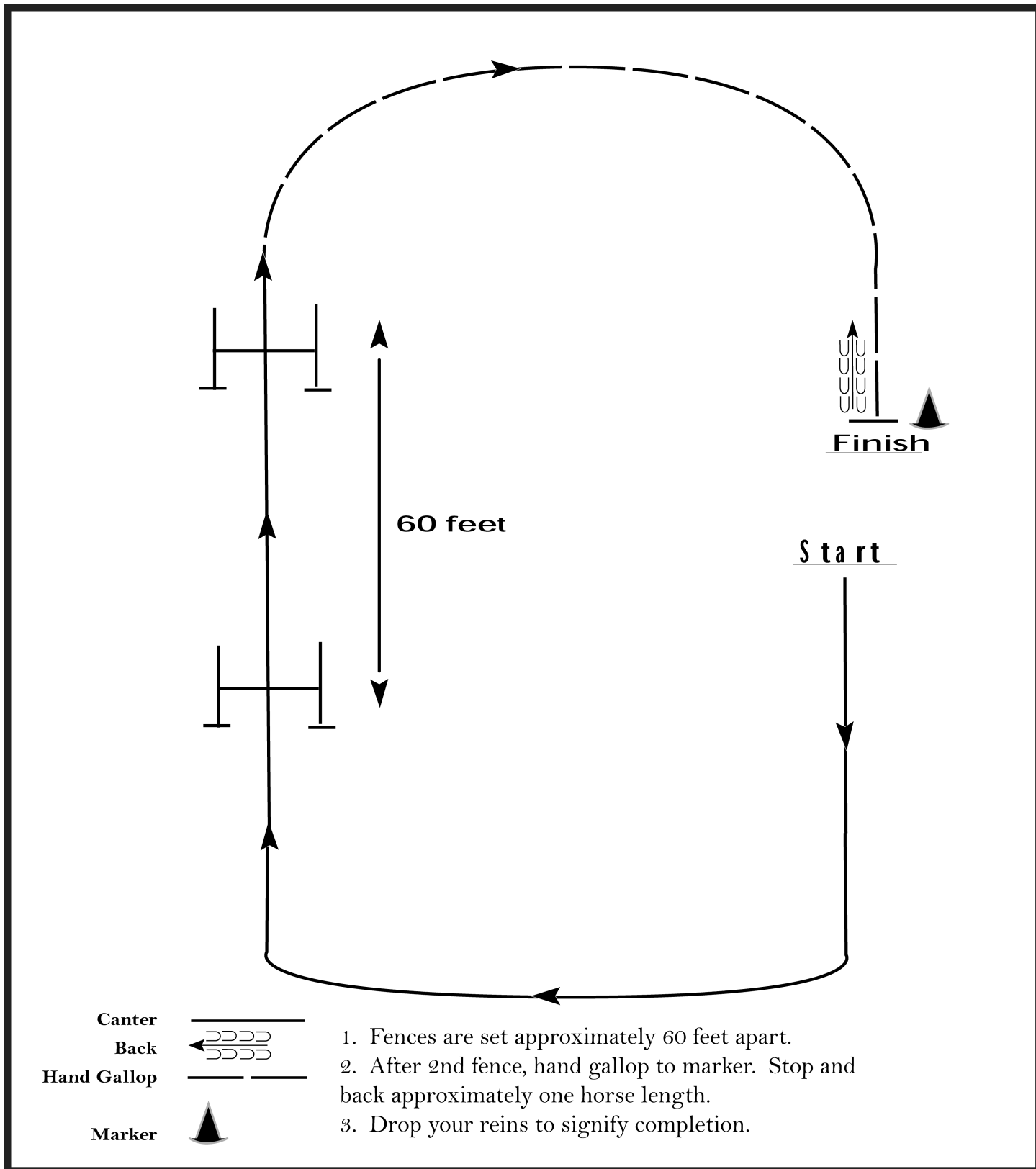

[HH/60-2]

Pattern Provided by:

California 4-H Horse Classic

# California 4-H Horse Classic

## Equitation Over X-Rails up to 18" (Open (except Novice))

Show Date: 07-8-2024

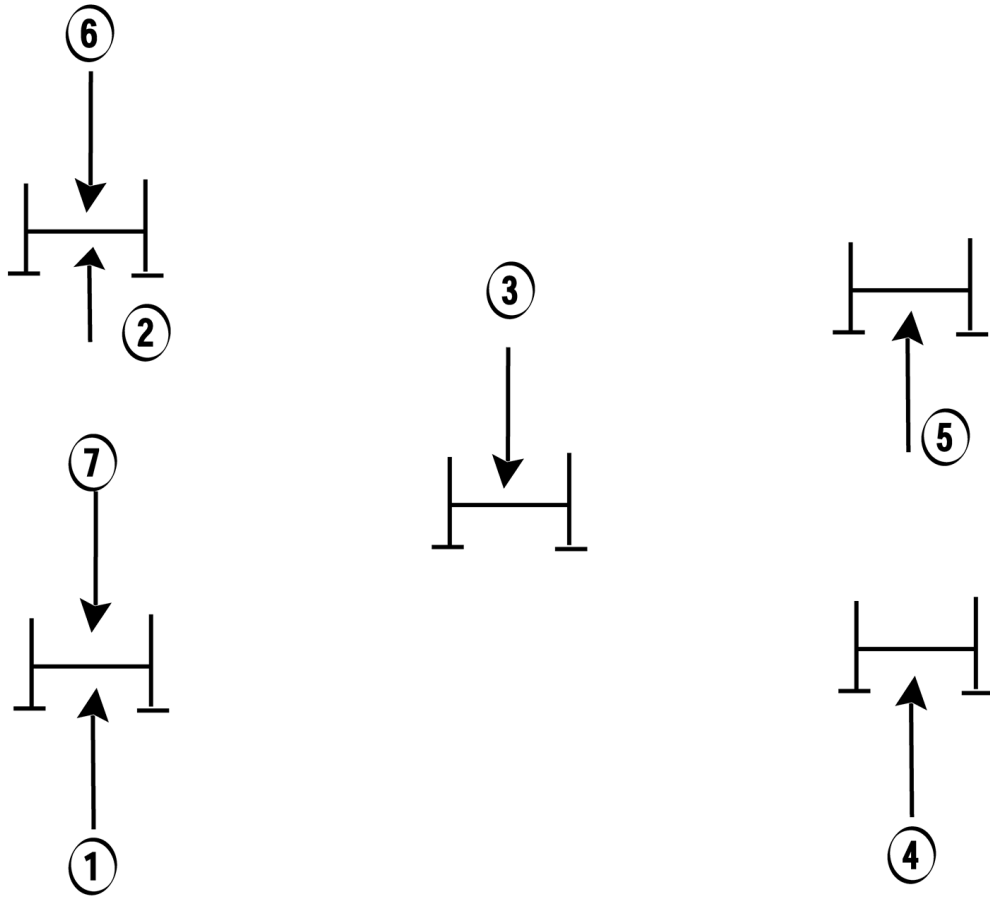

w w w . H o r s e S h o w P a t t e r n s . c o m

w w w . H o r s e S h o w P a t t e r n s . c o m

[MHP/H-7]

Pattern Provided by:

*California 4-H Horse Classic*

# California 4-H Horse Classic

Working Hunter Over X-Rails up to 18" (Open (except Novice))

Show Date: 07-8-2024

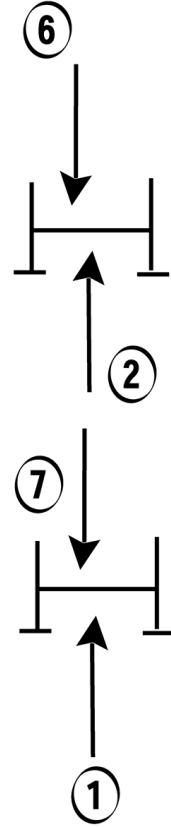
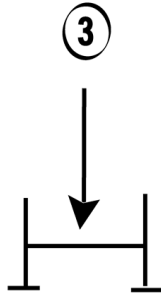
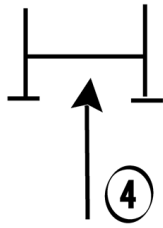
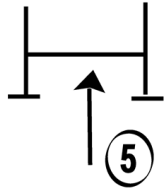

w w w . H o r s e S h o w P a t t e r n s . c o m

w w w . H o r s e S h o w P a t t e r n s . c o m

[MHP/H-8]

Pattern Provided by:

California 4-H Horse Classic

# California 4-H Horse Classic



## Hunter Hack up to 2' (Open (except Novice))

Show Date: 07-8-2024

www.HorseShowPatterns.com

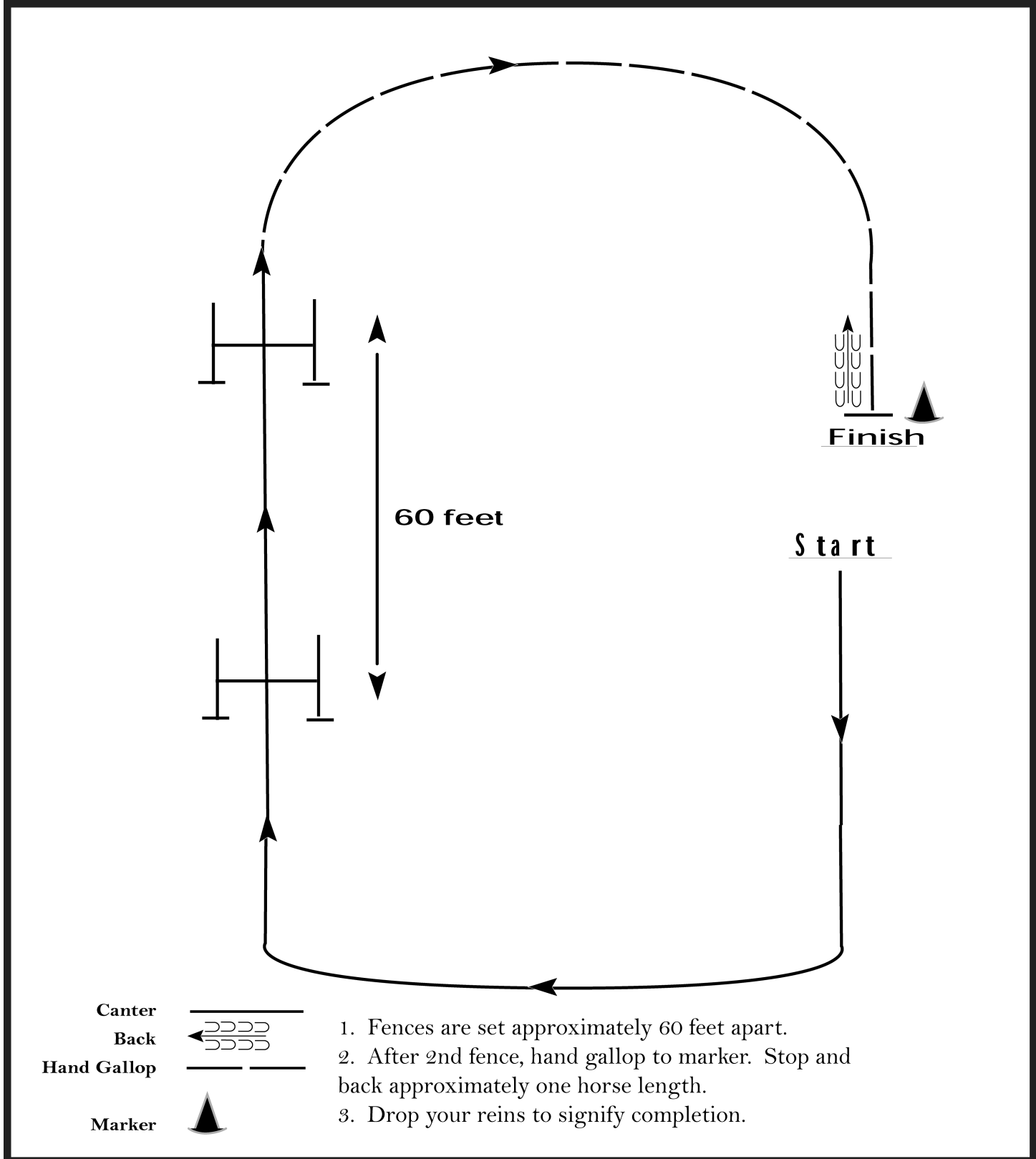
www.HorseShowPatterns.com

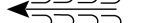

- Canter 
- Back 
- Hand Gallop 
- Marker 

1. Fences are set approximately 60 feet apart.
2. After 2nd fence, hand gallop to marker. Stop and back approximately one horse length.
3. Drop your reins to signify completion.

[HH/60-2]

Pattern Provided by:

California 4-H Horse Classic

# California 4-H Horse Classic

## Equitation Over Fences up to 2' (Open (except Novice))

Show Date: 07-8-2024

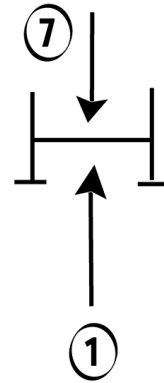
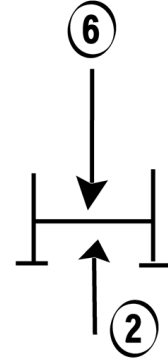
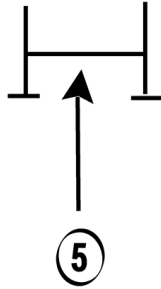
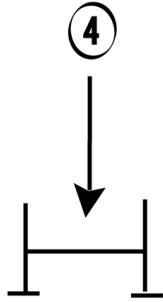
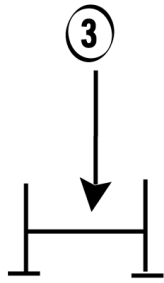

w w w . H o r s e S h o w P a t t e r n s . c o m

w w w . H o r s e S h o w P a t t e r n s . c o m

[MHP/H-6]

Pattern Provided by:

*California 4-H Horse Classic*

# California 4-H Horse Classic

Working Hunter Over Fences up to 2' (Open (except Novice))

Show Date: 07-8-2024

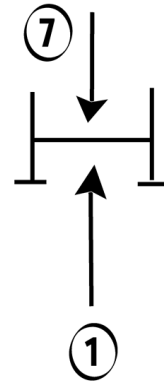
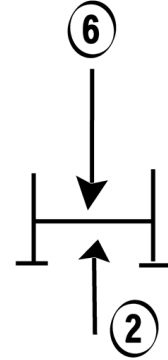
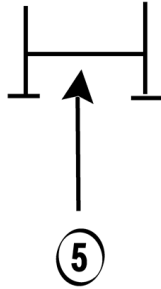
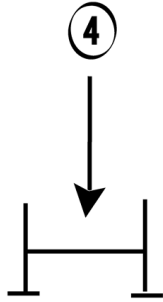
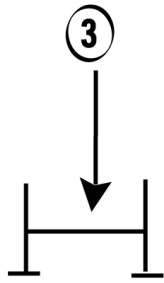

w w w . H o r s e S h o w P a t t e r n s . c o m

w w w . H o r s e S h o w P a t t e r n s . c o m

[MHP/H-6]

Pattern Provided by:

*California 4-H Horse Classic*

# California 4-H Horse Classic

Jumpers up to 2' (Open (except Novice))

Show Date: 07-8-2024

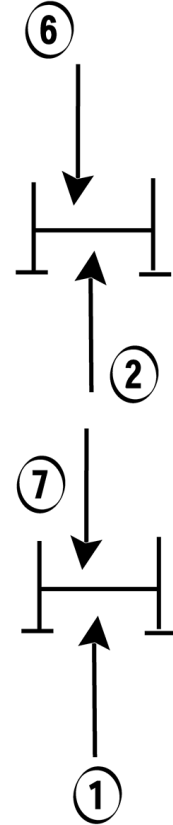
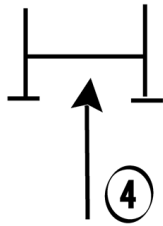
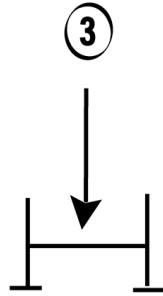
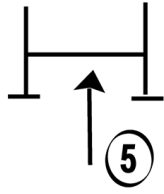

w w w . H o r s e S h o w P a t t e r n s . c o m

w w w . H o r s e S h o w P a t t e r n s . c o m

[MHP/H-8]

Pattern Provided by:

California 4-H Horse Classic





# California 4-H Horse Classic

Equitation Over Fences up to 2'3" (Open (except Novice))

Show Date: 07-8-2024

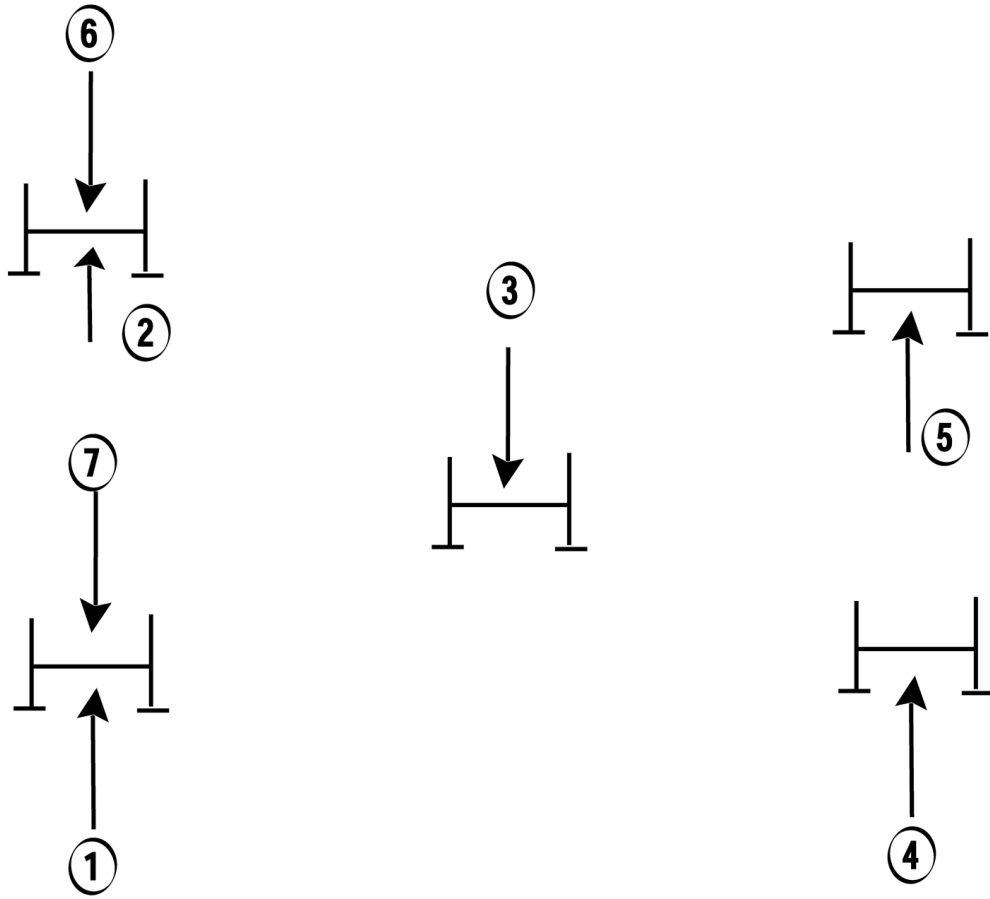

w w w . H o r s e S h o w P a t t e r n s . c o m

w w w . H o r s e S h o w P a t t e r n s . c o m

[MHP/H-7]

Pattern Provided by:

*California 4-H Horse Classic*

# California 4-H Horse Classic

Working Hunter Over Fences up to 2'3" (Open (except Novice))

Show Date: 07-8-2024

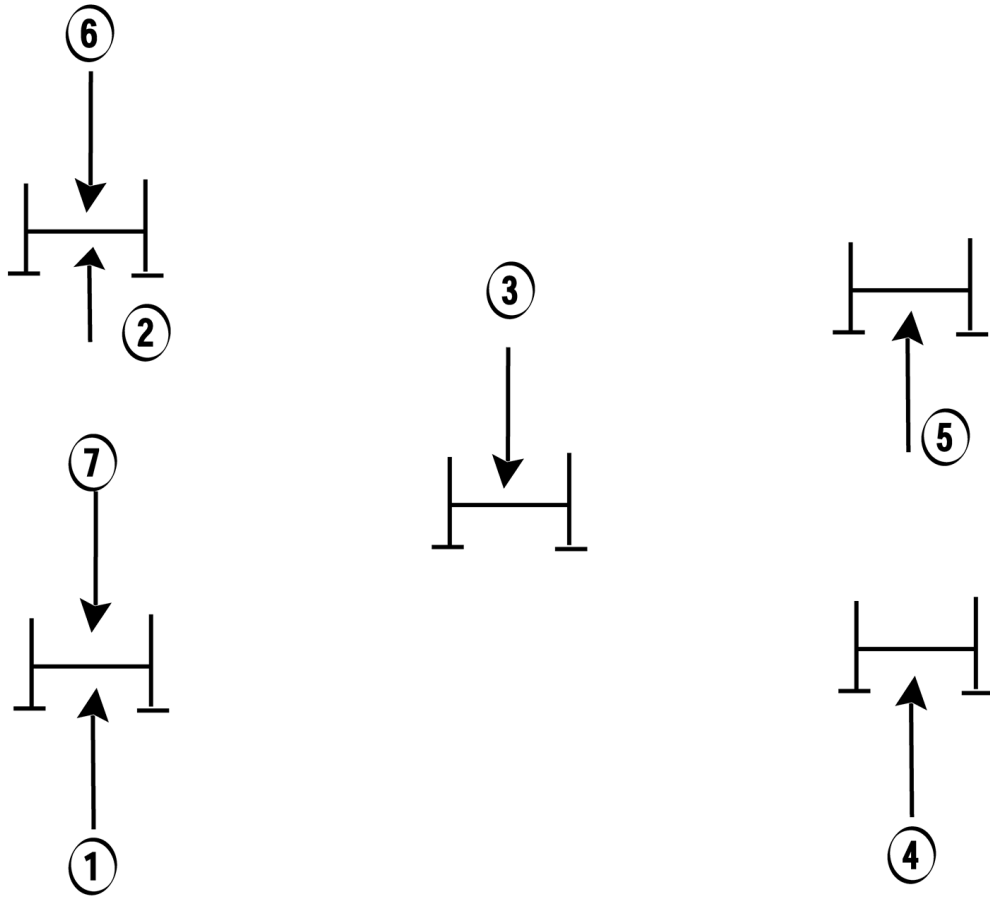

w w w . H o r s e S h o w P a t t e r n s . c o m

w w w . H o r s e S h o w P a t t e r n s . c o m

[MHP/H-7]

Pattern Provided by:

California 4-H Horse Classic

# California 4-H Horse Classic

Jumpers up to 2'3" (Open (except Novice))

Show Date: 07-8-2024

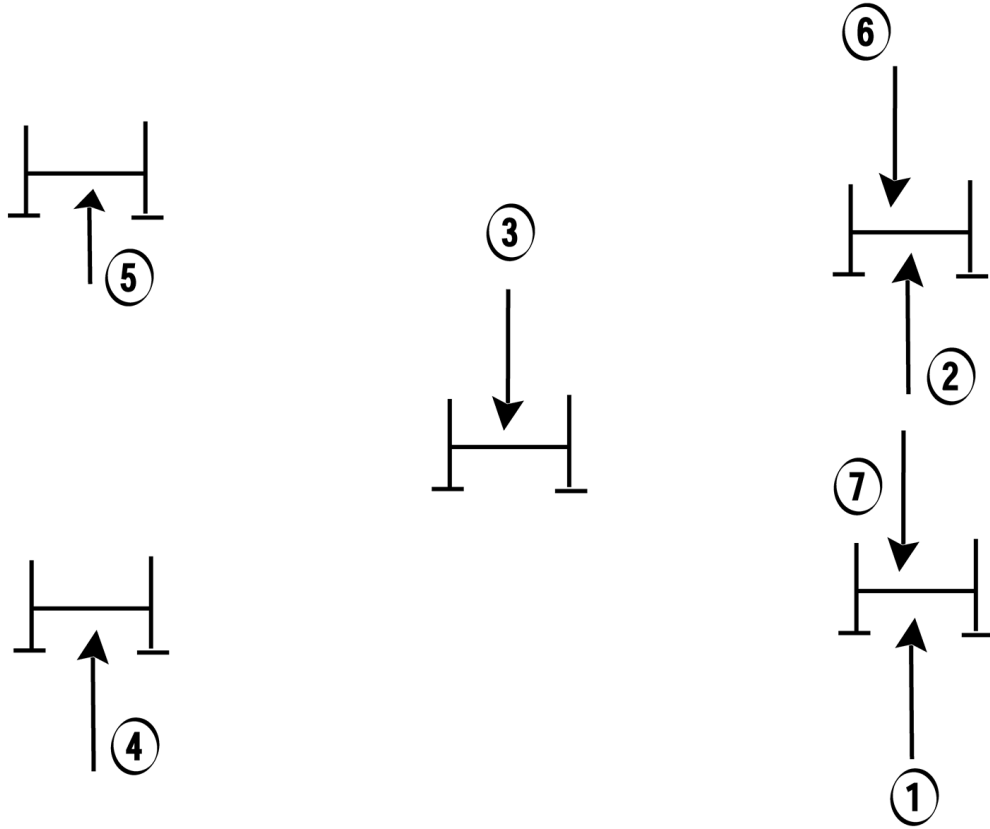

w w w . H o r s e S h o w P a t t e r n s . c o m

w w w . H o r s e S h o w P a t t e r n s . c o m

[MHP/H-8]

Pattern Provided by:

California 4-H Horse Classic