



UNIVERSITY OF CALIFORNIA

Division of Agriculture
and Natural Resources

<http://anrcatalog.ucdavis.edu>

Safe Methods of Canning Vegetables

LINDA J. HARRIS, Food Safety/Microbiology Specialist, Department of Food Science and Technology, University of California, Davis

Canning is an important and safe method of food preservation if practiced properly. The canning process involves placing food in jars and heating the jars to a temperature that destroys microorganisms that could be a health hazard or cause the food to spoil. This heating also destroys enzymes that may cause undesirable changes in the flavor, color, and texture of vegetables. Air is driven from the jar during heating, and as it cools, a vacuum seal is formed. The vacuum seal prevents air from getting back into the product, bringing with it microorganisms that would recontaminate the food.

CANNING BASICS

Botulism warning

With the exception of tomatoes (a fruit that is marketed as a vegetable), all vegetables are low in acid and have a pH value of greater than 4.6. These low-acid vegetables support the growth of the bacterium *Clostridium botulinum* when given the right conditions, which include moisture, room temperatures, lack of oxygen, and low-acid conditions. When growing, *Clostridium botulinum* produces an extremely potent toxin that causes the illness **botulism** in people even though the food may taste and appear normal. If untreated, botulism can cause death within a few days of consuming the toxic food. It is important to follow the directions in this publication carefully to make sure your canned foods are safe.

Select the right canner for each food

There are two safe methods of canning: water-bath (boiling-water) and pressure canning. Which one to use depends on the type of food being canned. High-acid foods such as most fruits, tomatoes, and pickled vegetables, as well as jams, jellies, and other preserves, can be safely processed using a water bath canner. Consult the resources listed in “For More Information” at the end of this publication for instructions on safely canning acidic foods using a water-bath or boiling-water canner.

Pressure canning is the only safe method for canning low-acid vegetables. *Clostridium botulinum* is not killed by boiling water (212°F, 100°C). A water temperature higher than boiling is necessary to kill the bacteria and safely process low-acid foods in a reasonable length of time. Pressure canners typically operate at a temperature of at least 240°F (116°C), which can be achieved only at pressures of greater than 10 pounds per square inch (69 Pa).

Pressure canners

A pressure canner is a specially made heavy pot with a lid that can be tightly closed to prevent steam from escaping. The lid is fitted with a vent, a dial or weighted pressure gauge, and a safety valve (figs. 1 and 2). Because each type of canner is different, read the manufacturer’s instructions on the care and use of your pressure canner. For safe operation of your pressure canner, clean the petcock or vent pipe and safety valve openings by drawing a clean string or narrow strip of cloth through them. Do this at the beginning of the canning season and often during the season. The pressure dial gauge on a canner



Note: Research on food preservation is ongoing—recommendations may change. **Make sure your food preservation information is always current. Always follow up-to-date, tested guidelines and recipes from reliable sources.** 12/2002

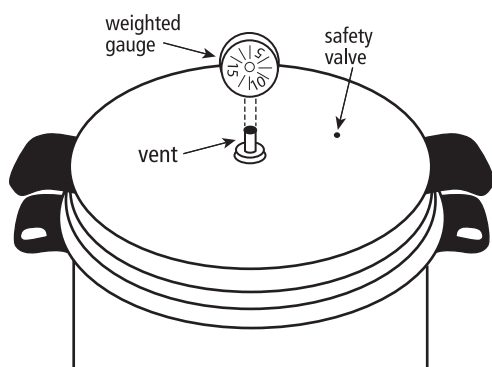

Figure 1. Weighted gauge pressure canner.

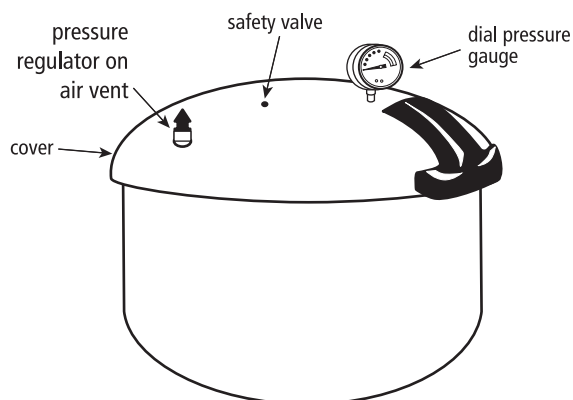

Figure 2. Dial gauge pressure canner.

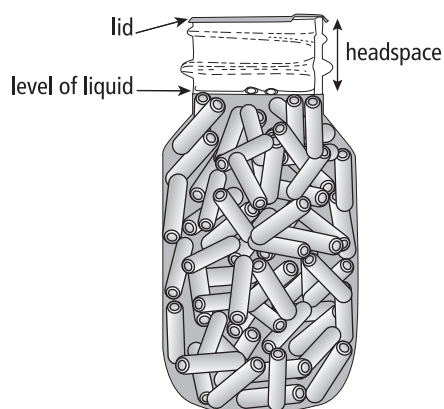

Figure 3. Leave adequate headspace in jars.

should be checked for accuracy on a yearly basis. Refer to the manufacturer's instructions or contact your local University of California Cooperative Extension county office for further information.

Preparation of vegetables

Select fresh, firm, crisp vegetables. Prepare vegetables in batches that will just fill the jars required for one load of your pressure canner. Wash and prepare the vegetables according to the directions in table 1. When precooking for the hot pack method, use a minimal amount of water. This water can be used as the covering liquid in the jars.

Canning without salt

It is not necessary to add salt for safety when canning vegetables. Salt is added for flavor and can sometimes help retain texture.

Glass jars

Make sure all jars are free of cracks and chips. These defects will prevent airtight seals. Jars that are manufactured for home canning are recommended. Mayonnaise jars and similar jars are not recommended for use in home canning because they are not manufactured for repeated heating and have a higher rate of breakage, particularly in pressure canners. Wash glass jars in hot, soapy water and rinse, or wash them in a dishwasher.

Lids and rings

For lids, select the size that fits your jars. Always use new lids each time you can. Follow the manufacturer's instructions for pretreating the canning lids. Metal lids have a sealing compound and usually need to be heated prior to use. Rings can be reused if they are in good condition. Wash and thoroughly dry the rings before storing and they will remain in good condition for years.

Filling jars

There are two methods for filling jars. In the **cold pack** or **raw pack method**, fresh, uncooked vegetables are packed into the jar (leaving the recommended headspace; see fig. 3), covered with boiling water, placed in the pressure canner, and heat-processed. In the **hot pack method**, fresh vegetables are partially cooked (2 to 5 minutes), packed immediately into hot jars (leaving the recommended headspace), covered with boiling water, placed in the pressure canner, and heat-processed. The hot pack method helps remove the air in vegetable tissues, helps prevent vegetables from floating, increases the vacuum in jars during processing, and improves shelf life. The hot pack method is often preferred because it allows more vegetables to fit into the jar.

In either method, do not overfill the jars. Pack the food to the shoulder of the jar, leaving room for the covering liquid and recommended headspace (see table 1).

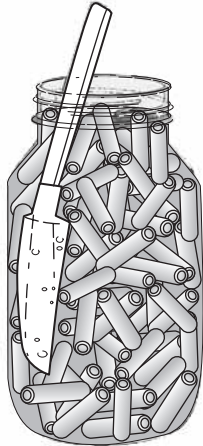

Figure 4. Use a knife or spatula to dislodge air bubbles.

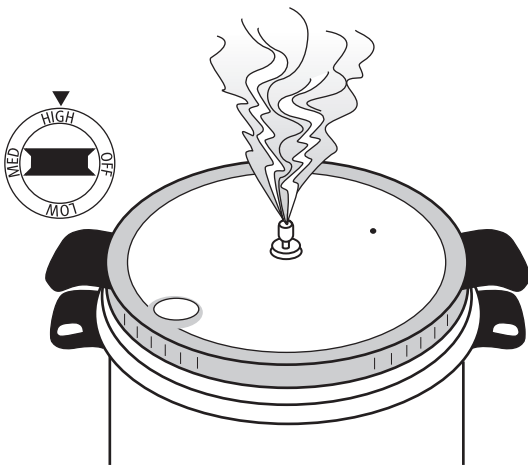

Figure 5. Venting the pressure canner.

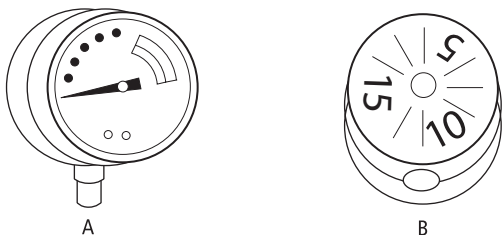

Figure 6. (A) Dial gauge. (B) Weighted gauge.

After adding liquid to the recommended headspace, use a plastic knife or spatula to dislodge air bubbles trapped inside the jars (fig. 4). Add more liquid if necessary. Follow the correct times for each vegetable and type of packing method given in table 1.

Adjusting seals

With a clean, damp cloth or towel, carefully wipe the rim and threads of the jar. Place the clean, prepared lid on the rim of the jar and firmly screw on the ring band. Do not overtighten. If tightened too much, the lids will not vent correctly, causing buckling of the lid, loss of the seal a day or two after processing, and possibly glass breakage during processing.

Filling the canner with jars

Start by putting 2 to 3 inches (5 to 7.5 cm) of hot tap water in the bottom of the pressure canner. Canners with weighted gauges that continually vent steam during the processing time require an additional inch or two of water if the recommended processing time is 60 minutes or more. This is to prevent the canner from going dry. Place jars on the rack that comes with the canner so that they do not touch the bottom or sides of the canner or each other.

If the canner is deep enough, a second layer of jars may be added. Use a rack to allow steam circulation and to prevent jars on the upper layer from tipping.

Venting the canner

Securely fasten the pressure canner lid according to the manufacturer's instructions. Leave the petcock or vent pipe open. Place the canner over high heat. Before processing the jars, drive all the air out of the canner by letting the steam escape (fig. 5). This is called "venting." Vent all canners for 10 minutes before closing them regardless of the manufacturer's instructions. Older publications may include shorter venting times that are now considered unsafe. If the air is not driven out, the temperature will not rise as high as it should at a given steam pressure, and spoilage and botulism may result.

Processing times for vegetables

Vegetables must be canned in a pressure canner at the appropriate pressure for the appropriate length of time to guarantee their safety. To can vegetables safely, use the directions and processing times given for vegetables in table 1.

Processing

Using table 1, determine the recommended pressure and processing time for the product and the size of the jar. After venting the canner properly, close the petcock or put on the weighted gauge, and then bring the canner to the recommended pressure that determines the safe processing temperature (fig. 6).

When the recommended pressure is reached, start timing. Process for the length of time given in table 1. Watch the pressure gauge during processing to make sure that the pressure does not fall below the recommended level. With weighted-gauge canners the gauge will either keep rocking gently or make a frequent “jiggling” noise to indicate that the correct pressure is being maintained. Check manufacturer’s instructions for maintaining recommended pressures.

Loss of pressure at any time can result in underprocessing and unsafe food. If the pressure goes below the recommended level at any time, bring the canner back to pressure and begin timing over again from the beginning using the total original processing time.

Processing at higher altitudes

The processing times given in table 1 are for altitudes of 0 to 1,000 feet (305 m). For higher altitudes, use the times given in table 1 and use the pressure given in table 2. The higher pressure is necessary to achieve correct processing temperatures.

Cooling the canner

After processing is finished, turn off the heat. It is best not to move the canner while it is cooling. If you do move the canner, do not place it on a cold surface. Wait at least 15 minutes after the pressure returns to zero before opening the petcock or the vent pipe closure. For canners equipped with a weighted gauge, cooling must be timed: approximately 30 minutes for pints and 45 minutes for quarts. Larger canners may take 1 hour to cool. After waiting the appropriate cooling time, no steam should escape when the weighted gauge is nudged. Open the petcock or vent pipe before removing the cover of the canner.

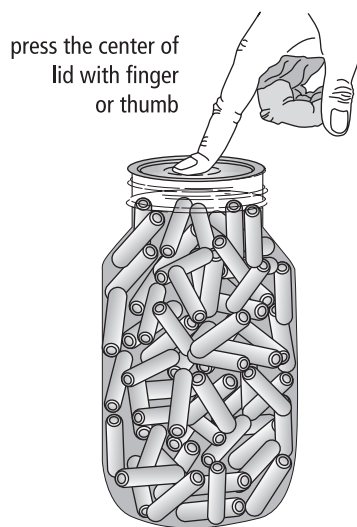

Figure 7. Press center of lid with finger.

After waiting the appropriate cooling time, no steam should escape when the weighted gauge is nudged. Open the petcock or vent pipe before removing the cover of the canner.

Opening the canner

To remove the canner lid, open the lid away from you to protect yourself from remaining steam that may escape.

Cooling, testing, and storing jars

Using a jar lifter, remove jars from the canner. Bubbling in the jars is normal; it means that the contents are boiling under vacuum and is a sign that the lid is positioned properly to create a seal. Set the jars on a board, rack, or folded cloth, not on a cold surface. Leave space between and around the jars for air to circulate as the jars cool. Be careful not to let the jars touch each other.

After the jars are completely cool (24 hours or more), check for seals on jars. Look at the top of each jar. If the lid is slightly concave (bent downward), it indicates a seal. Test the seal by pressing on the lid with your finger: the lid should not move (fig. 7). If you are not sure whether a jar is sealed, cautiously lift it by the lid after removing the ring band while supporting the jar with your other hand. If not properly sealed, the lid will come off. Remove ring bands at this stage. To loosen a ring band that sticks, cover with a hot, damp cloth or run under hot water for 1 to 2 minutes.

If a small amount of liquid has been lost from sealed jars do not open them to replace it. If the jar is sealed and the liquid is only slightly lower than the food, the food is safe. Plan to use these jars first as the food may discolor. If a large amount of liquid has been lost, refrigerate and use the product in 2 to 3 days or reprocess contents (see below).

Wash and dry ring bands and wipe the jars with a damp cloth. The bands may be replaced on the jars, if desired. Label and date the jars and store in a cool, dark, dry place.

Reprocessing

If a jar did not seal, refrigerate it and use the food within a few days, freeze the food, or reprocess it within 24 hours. To reprocess, use a new metal lid and check the jar for flaws. Empty the contents of the jar into a saucepan and bring to a boil. Fill clean, hot jars and process by the method originally advised and for the full length of time recommended. Use these jars first as the quality will be lower than those processed once.

PREVENTING BOTULISM

Using home-canned foods

If canning guidelines are followed exactly, there should be little concern about the quality and safety of your home-canned foods. However, it is always best to visually examine each jar before serving to make sure that no changes have occurred. If you are certain that the product was processed correctly and there is a secure vacuum seal, it may be served without additional cooking.

Improperly canned foods

Low-acid foods can contain the toxin that causes botulism without showing signs of spoilage. These foods are considered improperly canned if any of the following are true:

- The food was **not** processed in a pressure canner.
- The gauge of the canner was **inaccurate**.
- **Out-of-date** processing times and pressures were used.
- Processing pressure was **less than that given for the altitude** at which the food was canned.

These foods should be detoxified as described below and discarded.

Checking for spoilage

Before using the canned product, examine each jar carefully to make sure that a vacuum seal is present. Some spoilage produces gases that cause the lids to swell and/or break the seal. If the lids can be removed without having to pry them off, do not use the product.

Indications of food spoilage include

- broken seals
- seepage
- mold growth
- yeast growth
- gassiness
- fermentation
- spurting liquid when jar is opened
- sliminess
- cloudiness
- disagreeable odors

Opening jars

To open jars with vacuum-sealed lids, break the vacuum with a can opener and lift off the lid. This will prevent damage to the jar's sealing surface. Canning lids are not reusable. **Do not serve products that do not have a vacuum-sealed lid or products that show signs of spoilage.** If you suspect spoilage, discard the food.

Suspected spoilage

Jars suspected to contain spoiled product must be **handled very carefully**. If the container remains sealed, place it in a heavy plastic bag. Close the bag securely and discard it in a regular trash container. Unsealed jars require detoxification to prevent contamination from the possible presence of botulinum toxin (see below). Although the bacterium *Clostridium botulinum* is very resistant to heat, the toxin it produces is not.

Detoxification

Wearing rubber gloves, carefully remove the lids from the jar and place the jar containing spoiled food on its side in an 8-quart (7.5-l) volume, or larger, stock pot, pan, or boiling-water canner. Do not remove the food from the jar, since removal could contaminate other items. Place the lids in the pot with the jars. Wash your hands thoroughly. Carefully add water to the pot. The water should completely cover the jars with at least 1 inch (2.5 cm) of water above the jars. **Do not splash water or food product** outside the pot. Place a lid on the pot and heat the water to boiling. Boil for 30 minutes to make sure the food, jars, and lids are detoxified. Allow contents to cool. Drain the water and discard the food and lids in a heavy plastic trash bag, close the bag securely, and dispose in a regular trash container. The jars can be reused. Thoroughly wash all equipment, the can opener, work surfaces, clothing, and hands that may have come in contact with the product and container. Surfaces or utensils should be cleaned with a solution of 1 part chlorine bleach to 5 parts water. Wet the surface with this solution and let it stand 5 minutes before rinsing. Discard sponges or dishcloths used in the detoxifying process by putting them in a plastic trash bag and discarding in a trash container.

GENERAL CANNING QUESTIONS

How long will canned food keep?

Properly canned food stored in a cool, dry place will retain optimal eating quality for at least 1 year. Canned food stored in a warm place, such as near hot pipes, a range, a furnace, or in direct sunlight, may lose some of its eating quality in a few weeks or months, depending on the temperature. Dampness may corrode metal lids and cause leakage that will spoil the food.

Is it safe to process food in the oven?

No. Do not can in the oven. The temperatures needed for processing low-acid foods cannot be achieved without processing the food under pressure; they cannot be achieved in an oven.

What causes jars to break in a canner?

Breakage can occur for several reasons:

- using commercial food jars rather than jars manufactured for home canning
- using jars that have hairline cracks
- putting jars directly on the bottom of a canner instead of on a rack
- putting hot food in cold jars
- putting jars of raw or unheated food directly into boiling water in the canner rather than into hot water, causing a sudden change in temperature because of the difference between the temperature of the filled jars and the water in the canner before processing
- filling jars too full

What vegetables expand instead of shrink during processing?

Corn, peas, and lima beans are starchy and expand during processing. They should be packed loosely.

How do I can greens such as spinach and chard?

Freezing greens is recommended to obtain a better product.

Can I can pesto?

No. There are no home canning processes for pesto. Pesto is an uncooked seasoning mixture of herbs, usually including fresh basil, and some oil. It should be frozen for long-term storage.

Table 1. Preparing and canning vegetables

| Vegetable | How to prepare* | Processing time (minutes in pressure canner at 10 psi [weighted gauge] or 11 psi [dial]) | |
|--|--|---|-------|
| | | Pint | Quart |
| asparagus | Use 4- to 6-inch long, tender, tight-tipped spears. Wash and cut off scales (bracts). Cut into 1-inch pieces or leave whole. | | |
| | Hot pack: Cover asparagus with boiling water and boil for 2 to 3 minutes. Pack hot into hot jars, leaving a 1-inch headspace. Add salt if desired (½ teaspoon to pints, 1 teaspoon to quarts). Fill jars with boiling cooking liquid to 1 inch from the top. Remove air bubbles, wipe jar rims, adjust lids, and process. | 30 | 40 |
| | Raw pack: Pack asparagus tightly into hot jars, leaving a 1-inch headspace. Add salt if desired. Fill with boiling water to 1 inch from the top. Remove air bubbles, wipe jar rims, adjust lids, and process. | 30 | 40 |
| beans: dried kidney, etc. | Use mature dry beans or peas. Sort and remove defective or discolored beans. | | |
| | Hot pack: Soak in cold water for 12 to 18 hours in a cool place. Drain and add fresh water. Boil 30 minutes. Pack into hot jars, leaving a 1-inch headspace. Add salt if desired (½ teaspoon to pints, 1 teaspoon to quarts). Fill jars with boiling cooking liquid to 1 inch from the top. Remove air bubbles, wipe jar rims, adjust lids, and process. Raw pack is not recommended. | 75 | 90 |
| beans: dried navy, etc., with tomato or molasses | Use mature dry beans. Sort and remove defective or discolored beans. Wash beans and boil 2 minutes (use 3 cups of water for 1 cup of beans). Remove from heat and soak for 1 hour. Drain and reheat to boiling using fresh water. Use this cooking liquid to make sauce. | | |
| | Tomato sauce recipe 1: Mix 1 quart tomato juice, 3 tablespoons sugar, 2 teaspoons salt, 1 tablespoon chopped onion, and ¼ teaspoon each of ground cloves, allspice, mace, and cayenne. Add 3 cups of cooking liquid from beans. Heat to boiling. | | |
| | Tomato sauce recipe 2: Mix 1 cup tomato catsup with 3 cups cooking liquid from beans (or plain water). Heat to boiling. | | |
| | Molasses sauce: Mix 4 cups water or cooking liquid from beans, 3 tablespoons dark molasses, 1 tablespoon vinegar, 2 teaspoons salt, and ¾ teaspoon powdered dry mustard. Heat to boiling. Hot pack: Fill hot jars three-quarters full with hot beans. Add one ¾-inch cube of pork, ham, or bacon to each jar if desired. Fill jars with heated sauce, leaving a 1-inch headspace. Remove air bubbles, wipe jar rims, adjust lids, seal, and process. Do not add any more meat or bacon than directed. Raw pack is not recommended. | 65 | 75 |
| beans: fresh green (snap, wax, string, or Italian) | Use tender, crisp pods. Discard diseased or rusty pods. Wash and trim ends. Cut into 1-inch pieces or leave whole. | | |
| | Hot pack: Cover beans in boiling water and boil for 5 minutes. Pack hot into hot jars, leaving a 1-inch headspace. Add salt if desired (½ teaspoon to pints, 1 teaspoon to quarts). Fill jars with boiling cooking liquid to 1 inch from top. If beans are left whole, pack beans standing on ends. Remove air bubbles, wipe jar rims, adjust lids, and process. | 20 | 25 |
| | Raw pack: Pack beans tightly into hot jars, leaving a 1-inch headspace. Add salt if desired. Fill jars with boiling water to 1 inch from top. Remove air bubbles, wipe jar rims, adjust lids, and process. | 20 | 25 |
| beans: fresh lima | Use young, tender, well-filled pods. Discard damaged beans. Shell and wash beans thoroughly. | | |
| | Hot pack: Cover beans with boiling water and boil for 3 minutes. Pack loosely in hot jar, leaving a 1-inch headspace. Add salt if desired (½ teaspoon to pints, 1 teaspoon to quarts). Fill jars with boiling cooking liquid to 1 inch from top. Remove air bubbles, wipe jar rims, adjust lids, and process. | 40 | 50 |
| | Raw pack: Pack beans loosely in hot jars, leaving a 1-inch headspace for pints or 1½-inch (small beans) or 1¾-inch (large beans) headspace for quarts. Add salt if desired. Fill jars with boiling water to 1 inch from the top. Remove air bubbles, wipe jar rims, adjust lids, and process. | 40 | 50 |

Note: Research on food preservation is ongoing—recommendations may change. Make sure your food preservation information is always current. Always follow up-to-date, tested guidelines and recipes from reliable sources. 12/2002

Table 1. Preparing and canning vegetables, cont.

| Vegetable | How to prepare* | Processing time (minutes in pressure canner at 10 psi [weighted gauge] or 11 psi [dial gauge])† | |
|------------------------|--|--|-----------|
| | | Pint | Quart |
| beets: sliced or cubed | Use beets with a diameter of 1 to 2 inches. Beets larger than 3 inches in diameter are often fibrous. Scrub well. | | |
| | Hot pack: Leave roots and 1 inch of stems on beets. Boil until skins slip off (about 15 to 25 minutes). Dip in cold water. Peel, trim root and stem, and slice. Discard woody beets. Pack hot into hot jars, leaving a 1-inch headspace. Add salt if desired (½ teaspoon to pints, 1 teaspoon to quarts). Fill jars with boiling cooking liquid to 1 inch from the top. Remove air bubbles, wipe jar rims, adjust lids, and process. Raw pack is not recommended. | 30 | 35 |
| carrots | Select small carrots, preferably 1 to 1¼ inches in diameter. Wash, peel, and rewash carrots. Slice or dice. | | |
| | Hot pack: Cover carrots with water, bring to a boil, and simmer for 5 minutes. Pack hot into hot jars, leaving a 1-inch headspace. Add salt if desired (½ teaspoon to pints, 1 teaspoon to quarts). Fill jars with boiling cooking liquid to 1 inch from the top. Remove air bubbles, wipe jar rims, adjust lids, and process. | 25 | 30 |
| | Raw pack: Tightly pack sliced or asparagus-style carrots, leaving a 1-inch headspace. Add salt if desired (½ teaspoon to pints, 1 teaspoon to quarts). Fill jars with boiling water to 1 inch from top. Remove air bubbles, wipe jar rims, adjust lids, and process. | 25 | 30 |
| corn: cream style | Select slightly immature ears. Blanch ears 4 minutes in boiling water. Cut corn from the cob at the middle of the kernel. Scrape remaining corn from the cob with a table knife. | | |
| | Hot pack: Add 1 cup boiling water to 2 cups corn. Heat to boiling and simmer for 3 minutes. Pack hot into hot jars, leaving a 1-inch headspace. Add ½ teaspoon salt to pints if desired. Remove air bubbles, wipe jar rims, adjust lids, and process. Quart jars are not recommended. Raw pack is not recommended. | 85 | Don't use |
| corn: whole kernel | Select slightly immature ears. Blanch ears 3 minutes in boiling water. Cut corn from cob at about three-quarters of the depth of the kernel. Do not scrape cob. | | |
| | Hot pack: Add 1 cup of boiling water to 4 cups corn. Heat to a boil and simmer for 5 minutes. Pack hot corn into hot jars, leaving a 1-inch headspace. Add salt if desired (½ teaspoon to pints, 1 teaspoon to quarts). Fill jars with boiling cooking liquid to 1 inch from top. Remove air bubbles, wipe jar rims, adjust lids, and process. | 55 | 85 |
| | Raw pack: Pack corn into hot jars, leaving a 1-inch headspace. Add ½ teaspoon salt if desired. Fill jars with boiling water to 1 inch from the top. Remove air bubbles, wipe jar rims, adjust lids, and process. | 55 | 85 |
| mixed vegetables | Select your favorite mixture of vegetables, excluding greens, dried beans, cream style corn, winter squash, and sweet potatoes. Carrots, whole corn kernels, green and lima beans, crushed tomatoes, and zucchini make a good mix. Wash and prepare vegetables as described in this table. | | |
| | Hot pack: Combine all vegetables in a large pot and add enough water to cover. Boil 5 minutes. Pack hot into hot jars, leaving a 1-inch headspace. Add salt if desired (½ teaspoon to pints, 1 teaspoon to quarts). Fill jars with boiling cooking liquid to 1 inch from the top. Remove air bubbles, wipe jar rims, adjust lids, and process. Raw pack is not recommended. | 75 | 90 |
| mushrooms | Use fresh, small to medium-sized domestic mushrooms. Mushrooms should have short stems, unopened caps, and no discoloration. Do not can wild mushrooms. | | |
| | Hot pack: Trim stems and soak in cold water for 10 minutes to remove dirt. Wash in clean water. Leave small mushrooms whole; cut larger ones into halves or quarters. Cover in water and boil for 5 minutes. Pack hot into hot jars, leaving a 1-inch headspace. Add salt if desired (¼ teaspoon to half-pints, ½ teaspoon to pints). For better color add ⅛ teaspoon (375 mg) ascorbic acid per pint. Fill jars with boiling cooking liquid to 1 inch from the top. Remove air bubbles, wipe jar rims, adjust lids, and process. Quart jars are not recommended. Mushrooms will be overcooked if processed long enough to be safe in quart jars. Raw pack is not recommended. | 45 | Don't use |
| okra | Use young, tender pods. Discard diseased or rust-spotted pods. | | |
| | Hot pack: Wash and trim. Leave whole or cut into 1-inch pieces. Boil for 2 minutes and drain. Pack hot into hot jars, leaving a 1-inch headspace. Add salt if desired (½ teaspoon to pints, 1 teaspoon to quarts). Fill jars with boiling cooking liquid to 1 inch from the top. Remove air bubbles, wipe jar rims, adjust lids, and process. Raw pack is not recommended. | 25 | 40 |

Note: Research on food preservation is ongoing—recommendations may change. Make sure your food preservation information is always current. Always follow up-to-date, tested guidelines and recipes from reliable sources. 12/2002

Table 1. Preparing and canning vegetables, cont.

| Vegetable | How to prepare* | Processing time (minutes in pressure canner at 10 psi [weighted gauge] or 11 psi [dial gauge]) [†] | |
|---|---|--|-----------|
| | | Pint | Quart |
| onions | Use onions that are 1 inch diameter or less. Wash and peel onions. | | |
| | Hot pack: Cover onions in boiling water, bring to a boil, and boil for 5 minutes. Pack hot into hot jars, leaving a 1-inch headspace. Add salt if desired (½ teaspoon to pints, 1 teaspoon to quarts). Fill jars with boiling cooking liquid to 1 inch from the top. Remove air bubbles, wipe jar rims, adjust lids, and process. Raw pack is not recommended. | 40 | 40 |
| peas: fresh green | Use well-filled pods containing young, tender peas. Shell and wash peas. | | |
| | Hot pack: Cover with water and bring to a rolling boil for 2 minutes. Loosely pack hot into hot jars, leaving a 1-inch headspace. Add salt if desired (½ teaspoon to pints, 1 teaspoon to quarts). Fill jars with boiling cooking liquid to 1 inch from the top. Remove air bubbles, wipe jar rims, adjust lids, and process. | 40 | 40 |
| | Raw pack: Loosely pack peas into hot jars, leaving a 1-inch headspace. Add salt if desired. Fill jars with boiling water to 1 inch from the top. Remove air bubbles, wipe jar rims, adjust lids, and process. | 40 | 40 |
| peas: fresh black-eyed | Shell and wash peas. When packing the peas, do not shake the jar or press down on the contents. | | |
| | Hot pack: Cover with boiling water and boil for 3 minutes. Loosely pack hot into hot jars, leaving a 1-inch headspace for pints, 1½-inches headspace for quarts. Add salt if desired (½ teaspoon to pints, 1 teaspoon to quarts). Fill jars with boiling cooking liquid to 1 inch from the top. Remove air bubbles, wipe jar rims, adjust lids, and process. | 40 | 50 |
| | Raw pack: Loosely pack peas into hot jars, leaving headspace as specified above. Add salt if desired. Fill jars with boiling water, leaving headspace as above. Remove air bubbles, wipe jar rims, adjust lids, and process. | 40 | 50 |
| peppers: bell, pimento, and chilies | Use firm peppers. Wash and drain. Peel peppers by heating in a gas flame, on the barbecue, or roasting under the broiler until the skins blister. Put peppers in a covered bowl for 5 to 10 minutes. Skins will easily slip off. Remove stem and seeds. Flatten whole chili peppers to remove air. For other peppers, cut into strips or other convenient pieces. | | |
| | Hot pack: Pack loosely into hot jars, leaving a 1-inch headspace. Fill jars with boiling cooking liquid to 1 inch from the top. Add 1 tablespoon bottled lemon juice to each pint jar. Add ½ teaspoon salt to each pint jar if desired. Remove air bubbles, wipe jar rims, adjust lids, and process. Quart jars are not recommended. Raw pack is not recommended. | 35 | Don't use |
| potatoes: new | Use small to medium-sized mature potatoes. Potatoes stored below 45°F (7°C) may discolor when canned. For packing whole, choose potatoes that are 1 to 2 inches in diameter. Wash and peel potatoes. | | |
| | Hot pack: Cut into ½-inch cubes if desired. Soak in a solution of 1 teaspoon (3 g) ascorbic acid in 1 gallon of water. Drain and place potatoes in hot water and boil (10 minutes for whole, 2 minutes for cubes). Drain and pack hot into hot jars, leaving a 1-inch headspace. Add salt if desired (½ teaspoon to pints, 1 teaspoon to quarts). Fill with boiling cooking liquid to 1 inch from the top. Remove air bubbles, wipe jar rims, adjust lids, and process. Raw pack is not recommended. | 35 | 40 |
| potatoes: sweet | Use small to medium-sized potatoes. Can within 1 to 2 months after harvest. | | |
| | Hot pack: Wash and boil until partially soft (15 to 20 minutes), cool until you can remove skins. Peel, cut into pieces, and pack hot into hot jars, leaving a 1-inch headspace. Add salt if desired (½ teaspoon to pints, 1 teaspoon to quarts). Fill jars with boiling cooking liquid or sugar syrup (1 part sugar to 2 parts water) to 1 inch from the top. Remove air bubbles, wipe jar rims, adjust lids, and process. Do not mash or puree pieces. Raw pack is not recommended. | 65 | 90 |
| pumpkin or winter squash (acorn, banana, buttercup, butternut, or Hubbard): cubed | Use squash with hard rind and mature pulp. Small pumpkins are better for canning than large pumpkins. | | |
| | Hot pack: Wash, remove seeds, and peel. Cut into 1-inch cubes. Add enough water to cover and boil for 2 minutes. Pack hot cubes into hot jars, leaving a 1-inch headspace. Fill jars with boiling cooking liquid to 1 inch from the top. Remove air bubbles, wipe jar rims, adjust lids, and process. Do not mash or puree. Spaghetti squash should be frozen because its flesh does not stay cubed on heating. Raw pack is not recommended. | 55 | 90 |

Notes:

*Metric conversions: 1 teaspoon = 5 milliliters; 1 tablespoon = 15 milliliters; 1 cup = 0.24 liter; 1 pint = 0.47 liter; 1 quart = 0.95 liter; 1 gallon = 3.8 liters; 1 inch = 2.5 centimeters; 1 pound per square inch (psi) = 6.9 Pascals (Pa).

[†]Times are given for altitudes of 0 to 1,000 feet. For higher altitudes, see table 2.

Note: Research on food preservation is ongoing—recommendations may change. **Make sure your food preservation information is always current. Always follow up-to-date, tested guidelines and recipes from reliable sources. 12/2002**

Table 2. Canning pressures at higher altitudes

| Type of canner | Pressure (psi) | | | | |
|----------------|----------------|----------------|----------------|----------------|---------------|
| | 0–1,000 ft | 1,001–2,000 ft | 2,001–4,000 ft | 4,001–6,000 ft | over 6,000 ft |
| dial gauge | 11 | 11 | 12 | 13 | 14 |
| weighted gauge | 10 | 15 | 15 | 15 | 15 |

Note: Metric conversions: 1,000 feet (ft) = 305 meters; 1 pound per square inch (psi) = 6.9 Pascals.

ACKNOWLEDGMENTS

Special thanks to Norma Wightman for preparing the first draft of this revision and to Hsu Ling Tan for her assistance in collecting resource materials. Portions of this publication have been revised and updated from *Home Canning of Fruits and Vegetables* by George K. York and Paulette DeJong (UC DANR Leaflet 21392, 1984) and *So Easy to Preserve* (University of Georgia Cooperative Extension Bulletin 989).

FOR MORE INFORMATION

National Center for Home Preservation Web site, www.homefoodpreservation.com

University of California FoodSafe Program Web site,
<http://foodsafe.ucdavis.edu/CONSUMER/preserve.html>

University of Georgia College of Family and Consumer Sciences Food Safety and Preservation Publications Web site, http://www.fcs.uga.edu/extension/food_pubs.php

USDA Complete Guide to Home Canning, available via Internet at
<http://www.fcs.uga.edu/pubs/current/FDNS-E-39.html>

Visit our online catalog at <http://anrcatalog.ucdavis.edu>. You can also place orders by mail, phone, or FAX, or request a printed catalog of publications, slide sets, CD-ROMs, and videos from

University of California
Agriculture and Natural Resources
Communication Services
6701 San Pablo Avenue, 2nd Floor
Oakland, California 94608-1239

Telephone: (800) 994-8849 or (510) 642-2431, FAX: (510) 643-5470

E-mail inquiries: danrcs@ucdavis.edu

An electronic version of this publication is available on the ANR Communication Services Web site at <http://anrcatalog.ucdavis.edu>.

Publication 8072

© 2002 by the Regents of the University of California, Division of Agriculture and Natural Resources. All rights reserved.

The University of California prohibits discrimination against or harassment of any person employed by or seeking employment with the University on the basis of race, color, national origin, religion, sex, physical or mental disability, medical condition (cancer-related or genetic characteristics), ancestry, marital status, age, sexual orientation, citizenship, or status as a covered veteran (special disabled veteran, Vietnam-era veteran or any other veteran who served on active duty during a war or in a campaign or expedition for which a campaign badge has been authorized). University Policy is intended to be consistent with the provisions of applicable State and Federal laws.

Inquiries regarding the University's nondiscrimination policies may be directed to the Affirmative Action/Staff Personnel Services Director, University of California, Agriculture and Natural Resources, 300 Lakeside Drive, 6th Floor, Oakland, CA 94612-3550 (510) 987-0096. For a free catalog of other publications, call (800) 994-8849. For help downloading this publication, call (530) 754-5112.

pr-1/03-SB/CR



This publication has been anonymously peer reviewed for technical accuracy by University of California scientists and other qualified professionals. This review process was managed by the ANR Associate Editor for Food and Nutrition.